



# User's Manual

## Saturn PX 360 Fisheye



Follow us on



© 2015 Ernitec. All rights reserved  
[www.ernitec.com](http://www.ernitec.com)

Ernitec  
Tempovej 41  
2750 Ballerup  
Denmark

# Table of Contents

<b>1. Overview</b> .....	<b>2</b>
1.1 Features .....	2
1.2 Package Contents .....	3
1.3 Dimensions.....	5
1.4 Connectors (Indoor Only).....	6
1.5 Function Cables (Outdoor Only) .....	7
<b>2. Camera Cabling</b> .....	<b>8</b>
2.1 Power Connection .....	8
2.2 Ethernet Cable Connection.....	8
2.3 Connect Alarm I/O .....	8
2.4 Waterproof Cable Connector (Outdoor Only).....	9
<b>3. System Requirements</b> .....	<b>11</b>
<b>4. Access Camera</b> .....	<b>12</b>
<b>5. Setup Video Resolution</b> .....	<b>16</b>
<b>6. Configuration Files Export / Import</b> .....	<b>17</b>
<b>7. Tech Support Information</b> .....	<b>18</b>
7.1 Delete the Existing DCViewer.....	18
7.2 Setup Internet Security .....	19
<b>Appendix: Technical Specifications</b>	

# 1. Overview

The Hyper Mini Fisheye IP Camera is a high resolution surveillance solution features 360° wide coverage without blind spots. The fisheye camera supports resolution up to 6 Megapixels streaming at 30 fps which allows the videos to be viewed smoothly. Moreover, the fisheye camera supports digital PTZ, panoramic view and several display modes to fulfill users' needs. With the Compact and Concise design, Mini Fisheye Camera is suitable to apply in many kinds of environment, such as office room, hotel, vehicles, etc.

Furthermore, the embedded edge dewarping engine enables the fisheye camera to dewarp images by camera rather than backend system. Therefore, edge dewarping technique reduces the burden of backend system and also enhances the flexibility of usage. Featuring IR LED module and Smart Picture Quality/Noise Reduction improves the image quality in low light environments.

## 1.1 Features







- Progressive Scan CMOS Sensor
- Software Dewarping- 12M Resolution + 720P Real-Time\*
- Edge Dewarping, Up to 4M Resolution Real-time
- Quad Streams Compression- H.264 Baseline / Main / High Profile + MJPEG
- Multiple Dewarp Display Modes-  
Digital PTZ / Panorama View / Quad View
- Smart Event Function-  
Motion Detection / Network Failure Detection / Tampering Alarm / Periodical Event / Manual Trigger Event / Audio Detection
- Multiple and Dynamic Region of Interest (ROI) Windows
- Smart TextOverlay and Privacy Masks
- Wide Dynamic Range
- Day / Night (ICR)
- IR LED Module
- Built-in MIC & Speaker\*
- 2D/3D Noise Reduction / Color Noise Reduction
- Weatherproof (IP66 International)\*
- microSD and NAS Recording Support
- Compact and Concise Design
- ONVIF Support
- IK10

(\*) Optional

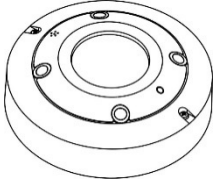
## 1.2 Package Contents

Please check the package contains the following items listed below.

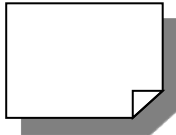
### Indoor

 Hyper Mini Fisheye IP Camera	 Self-Tapping Screw (x3)	 Plastic Anchor (x3)	
 Security Torx	 Power Terminal Block	 Quick Guide	 USB-key









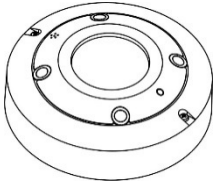

**NOTE:** Users **MUST** pre-drill and use plastic anchors before fastening the supplied self-tapping screws on the wall.

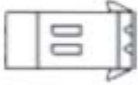

**NOTE:** To purchase power adaptor, please contact the camera manufacturer for further information.

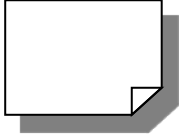
## Outdoor

 <p>Hyper Mini Fisheye IP Camera</p>	 <p>Self-Tapping Screw (x3)</p>	 <p>Plastic Anchor (x3)</p>	 <p>Security Torx</p>
 <p>Power Terminal Block</p>	 <p>Alarm I/O Terminal Block</p>	 <p>Quick Guide</p>	 <p>USB-Key</p>



**NOTE:** Users **MUST** pre-drill and use plastic anchors before fastening the supplied self-tapping screws on the wall.



**NOTE:** To purchase power adaptor, please contact the camera manufacturer for further information.

## 1.3 Dimensions

The dimensions of the camera are shown below.

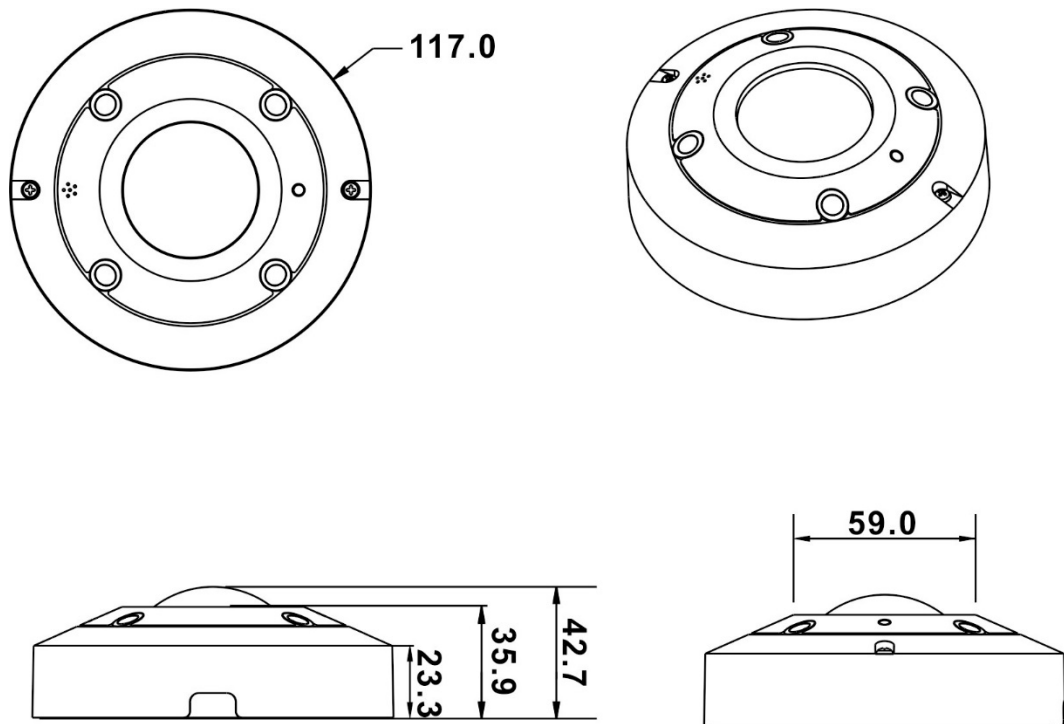

Unit: mm

## 1.4 Connectors (Indoor Only)

Please loosen the security screws and open the cover to reach the connectors.

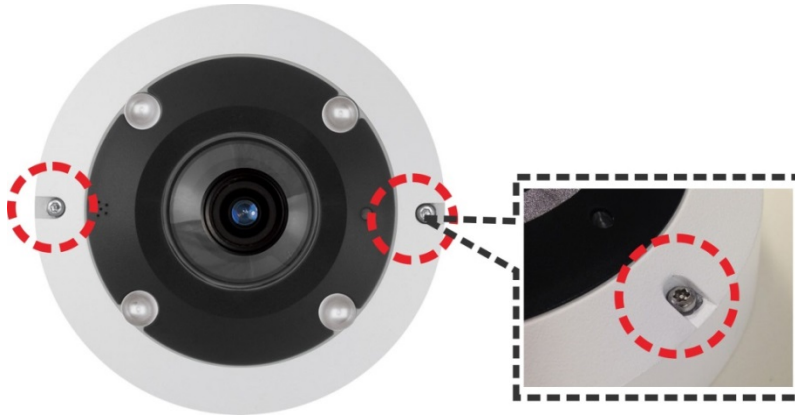

The diagram below shows the connectors of the camera. Definition for each connector is given as follows.

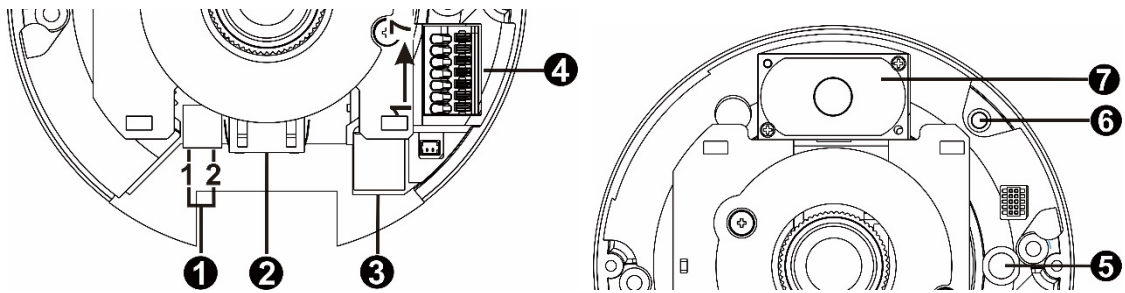

No.	Connector	Pin	Definition	Remarks	
1	Power	DC 12V	1	DC 12V	Power connection
			2	Reserved	
2	RJ-45	-	For network and PoE connections		
3	microSD Card Slot	-	Insert the microSD card into the card slot to store videos and snapshots. Do not remove the microSD card when the camera is powered on.		
4	Alarm & Audio I/O	1	Alarm Out +	Alarm connection	
		2	Alarm Out -		
		3	Alarm In +		
		4	Alarm In -	Ground connection	
		5	GND		
6	Audio Out	Two-way audio transmission			
7	Audio In				
5	Built-in Microphone	-	Audio In		
6	Default Button	-	Press the button with a proper tool for at least 20 seconds to restore the system.		
7	Speaker	-	Audio Out		



**NOTE:** It is not recommended to record with the microSD card for 24/7 continuously, as it may not be able to support long term continuous data read/write. Please contact the manufacturer of the microSD card for information regarding the reliability and the life expectancy.

## 1.5 Function Cables (Outdoor Only)

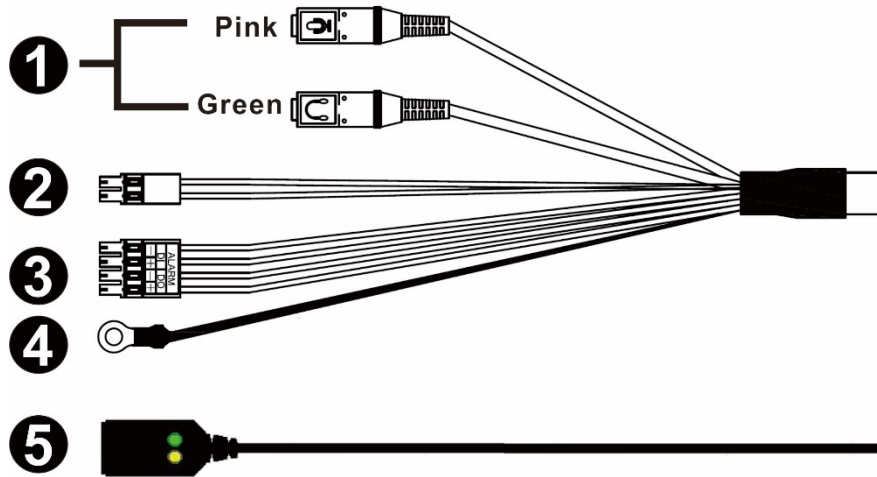

No.	Connector	Pin	Definition	Remarks
1	Audio I/O	Pink	Audio In	Two-way audio transmission
		Green	Audio Out	
2	Power (DC 12V) (2-Pin Terminal Block)	Black	DC 12V –	Power connection
		Red	DC 12V +	
3	Alarm I/O (4-Pin Terminal Block)	1	Alarm In –	Alarm connection
		2	Alarm In +	
		3	Alarm Out –	
		4	Alarm Out +	
4	GND	-	GND	Ground connection
5	RJ-45	-	For network and PoE connections	
-	Default Button	-	Refer to the Default Button in the table under <a href="#">Connectors (Indoor Only)</a> .	
-	microSD Card Slot	-	Refer to the microSD Card Slot in the table under <a href="#">Connectors (Indoor Only)</a> .	



## 2. Camera Cabling

Please follow the instructions below to complete the cable connections.

### 2.1 Power Connection

For power connection, please refer to section [Connectors \(Indoor Only\)](#) for the indoor models, and see section [All in One Cable \(Outdoor Only\)](#) for the outdoor models. Alternatively, users can power the camera by PoE if a Power Sourcing Equipment (PSE) switch is available. Refer to the section below for Ethernet cable connection.



**NOTE:** If PoE is used, make sure PSE is in used in the network.

### 2.2 Ethernet Cable Connection

To have best transmission quality, cable length shall not exceed 100 meters. Connect one end of the Ethernet cable to the RJ-45 connector of the camera, and plug the other end of the cable to the network switch or PC.



**NOTE:** In some cases, Ethernet crossover cable might be needed when connecting the camera directly to the PC.

Check the status of the link indicator and the activity indicator LEDs. If the LEDs are unlit, please check the LAN connection.

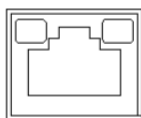

Green Link Light indicates good network connection.

Orange Activity Light flashes for network activity indication.

### 2.3 Connect Alarm I/O

The camera supports one alarm input and one relay output for alarm application. Refer to section [Connectors](#) for pin definitions.



**NOTE:** Do **NOT** connect external power supply to the alarm I/O connector of the IP camera.

## 2.4 Waterproof Cable Connector (Outdoor Only)

Follow the instruction below to waterproof the connectors of different types of cables. The supported cables are as shown below.

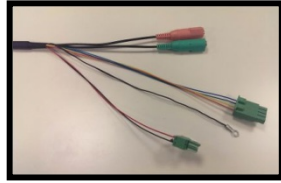

**All-in-One Cable**



**IP66 RJ-45 Cable**

### All-in-One Cable

Follow the steps below to waterproof the connectors of the All-in-One cable.

#### **Step 1:**

Connect the required devices to the All-in-One cable and coat the joints with silicone gel. There should be no gap between the connectors and the cables. For the alarm I/O connector and the power connector, make sure the side with wires attached is also sealed with silicone gel.

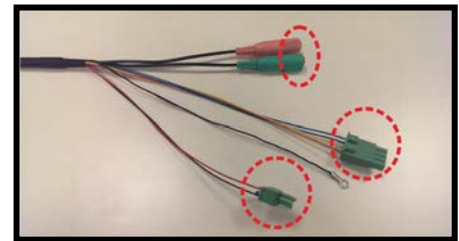

In addition, attach the ground cable to the ground and wrap the wires with silicone gel. Make sure the wires are not exposed to the air.

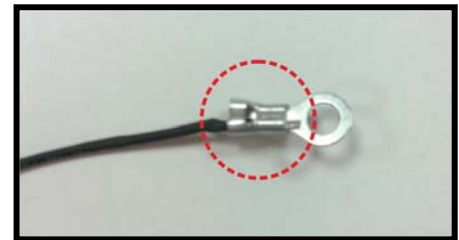

#### **Step 2:**

Seal the end of the rubber coating of the All-in-One cable as indicated in the figure on the right. Please use enough silicone gel to fill in the hose and wrap around each wire; otherwise, waterproof function cannot be guaranteed.

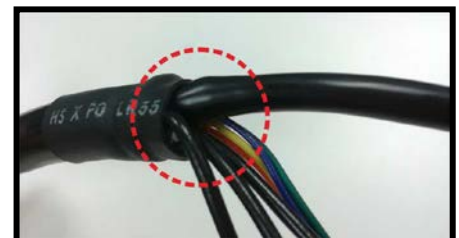

### **IP66 RJ-45 Cable**

For IP66 RJ-45 cable, please use an RJ-45 IP66 plug for connection to prevent water damage. Follow the steps below for cable connection.

#### **Step 1:**

Take out the supplied connector from the RJ-45 IP66 plug. Loosen the thread-lock sealing nut on the plug. Then thread the Ethernet cable through the thread-lock sealing nut and the plug. If the Ethernet cable is already attached to a connector, please remove it first.

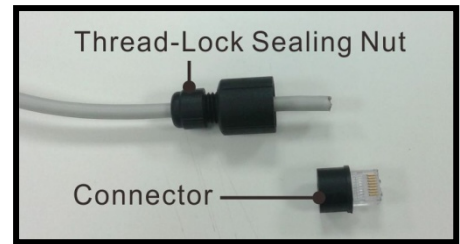

#### **Step 2:**

Carefully remove a section of rubber coating from the end of the Ethernet cable to reveal the wires. Inset the wires to the correct pins of the connector. Plug the Ethernet cable to the connector of IP66 RJ-45 cable.



#### **Step 3:**

Fasten the RJ-45 IP66 plug to the connector of the IP66 RJ-45 cable. Lastly, tighten the thread-lock sealing nut to the plug.



### 3. System Requirements

To perform the IP camera via web browser, please ensure the PC is in good network connection, and meet system requirements as described below.

Items	System Requirement
<b>Personal Computer</b>	<b>Minimum :</b> 1. Intel® Core™ i5-2430M @ 2.4 GHz 2. 4 GB RAM
	<b>Recommended:</b> 1. Intel® Core™ i7-870 @ 2.93 GHz 2. 8 GB RAM
<b>Operating System</b>	Windows VISTA / Windows XP / Windows 7
<b>Web Browser</b>	Microsoft Internet Explorer 7.0 or later (recommended) Firefox (32-bit) Safari
<b>Network Card</b>	10Base-T (10 Mbps) or 100Base-TX (100 Mbps) or 1000Base-T (1000 Mbps) operation
<b>Viewer</b>	ActiveX control plug-in for Microsoft IE Apple QuickTime 7.7.7 or before for Firefox



**NOTE:** To purchase power adaptor, please contact the camera manufacturer for further information.

## 4. Access Camera

For initial access to the IP camera, users can search the camera through the installer program: DeviceSearch.exe, which can be found in “DeviceSearch” folder in the supplied CD.

### Accessing the Camera by Device Search Software

- Step 1:** Double click on the program Device Search.exe.
- Step 2:** After its window appears, click on the <Device Search> button on the top. All the finding IP devices will be listed in the page.
- Step 3:** Find the camera in the list by its IP address and click on it. The default IP address of the camera is: **192.168.0.250**.
- Step 4:** The default IP address of the camera may not be in the same LAN as the IP address of the PC. If so, the IP address of the camera needs to be changed. Right click on the camera and click <Network Setup>. Meanwhile, record the MAC address of the camera, for future identification.
- Step 5:** The <Network Setup> page will come out. Select <DHCP> and click <Apply> down the page. The camera will be assigned with a new IP address.
- Step 6:** Click <OK> on the Note of setting change. Wait for one minute to re-search the camera.
- Step 7:** Click on the <Device Search> button to re-search all the devices. Find the camera in the list by its MAC address. Then double click or right click and select <Browse> to access the camera directly via a web browser.

**Step 8:** A prompt window requesting for default username and password will appear. Enter the default username and password shown below to login to the camera.

Login ID	Password
Admin	1234



**NOTE:** ID and password are case sensitive.



**NOTE:** It is strongly advised that administrator's password be altered for the security concerns. Refer to the [Hyper IP Camera Menu Tree](#) in the supplied CD for further details.

### **Installing DCViewer Software Online**

For initial access to the camera, a client program, DCViewer, will be automatically installed to the PC when connecting to the camera.

If the web browser doesn't allow DCViewer installation, please check the Internet security settings or ActiveX controls and plug-ins settings (refer to section [Setup Internet Security](#)) to continue the process.

The Information Bar (just below the URL bar) may come out and ask for permission to install the ActiveX Control for displaying video in browser. Right click on the Information Bar and select <Install ActiveX Control...> to allow the installation.

The download procedure of DCViewer software is specified as follows.

**Step 1:** In the DCViewer installation window, click on <Next> to start installation.

**Step 2:** The status bar will show the installation progress. After the installation is completed, click on <Finish> to exit the installation process.

**Step 3:** Click on <Finish> to close the DCViewer installation page.

Once the Viewer is successfully installed, the Home page of the IP camera will be shown as the figure below.

### Ceiling Mount Installed Camera

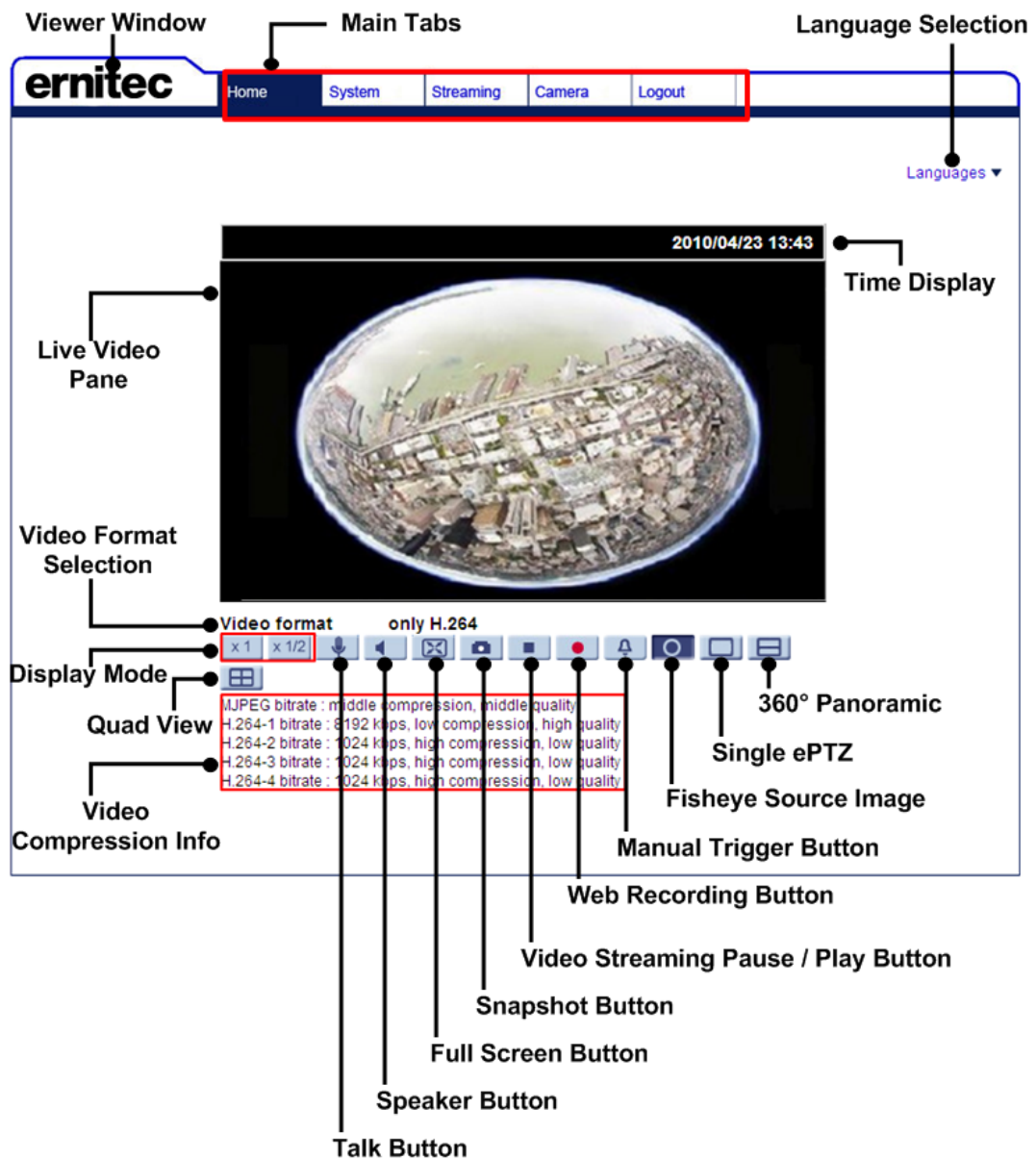

## Wall Mount Installed Camera

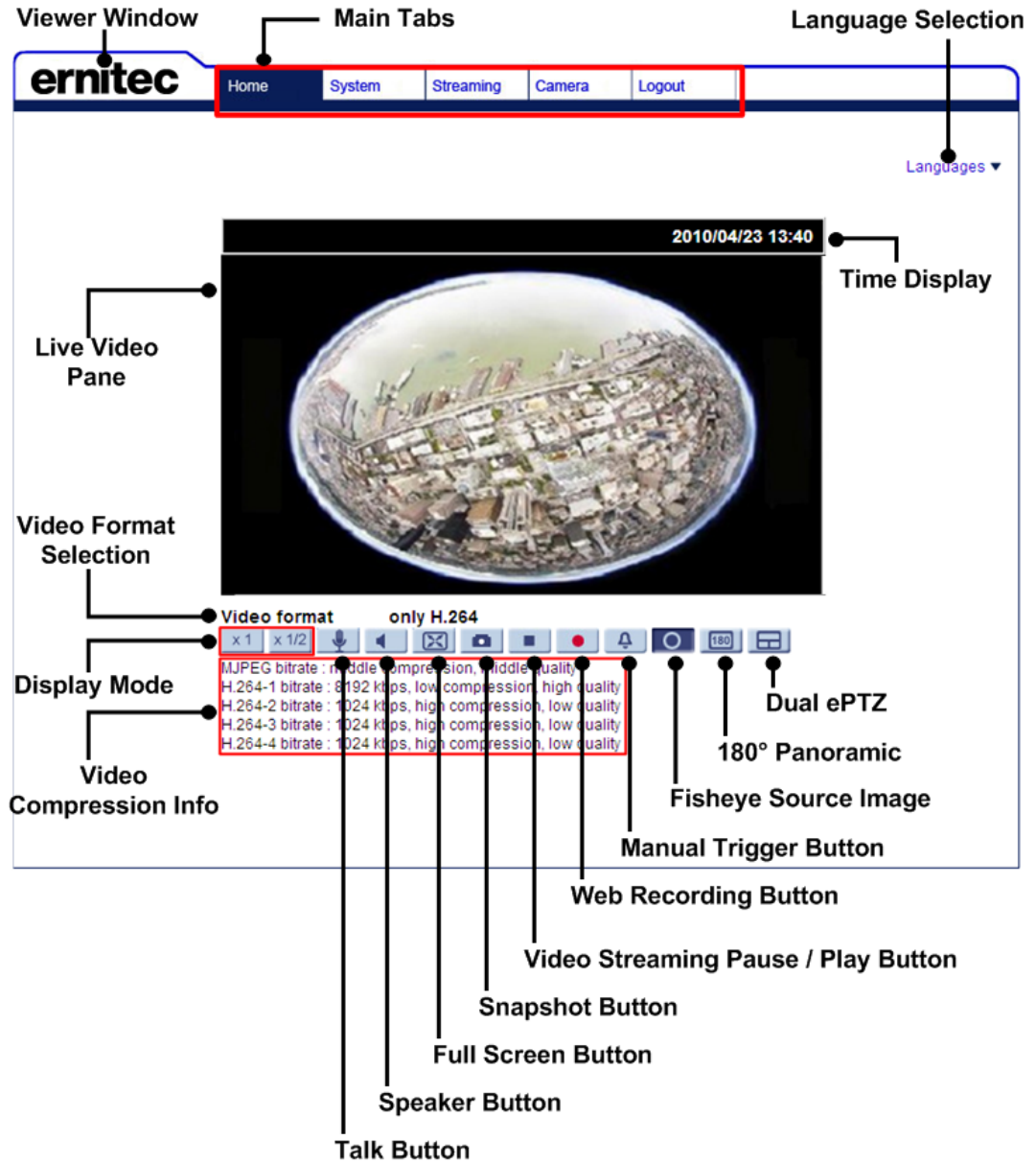

**NOTE:** For more details about the function buttons on the Home page, please refer to the [Hyper IP Camera Menu Tree](#) in the supplied CD.



## 5. Setup Video Resolution

Users can setup video resolution on Video Format page of the user-friendly browser-based configuration interface.

Video Format can be found under this path: **Streaming> Video Format**.

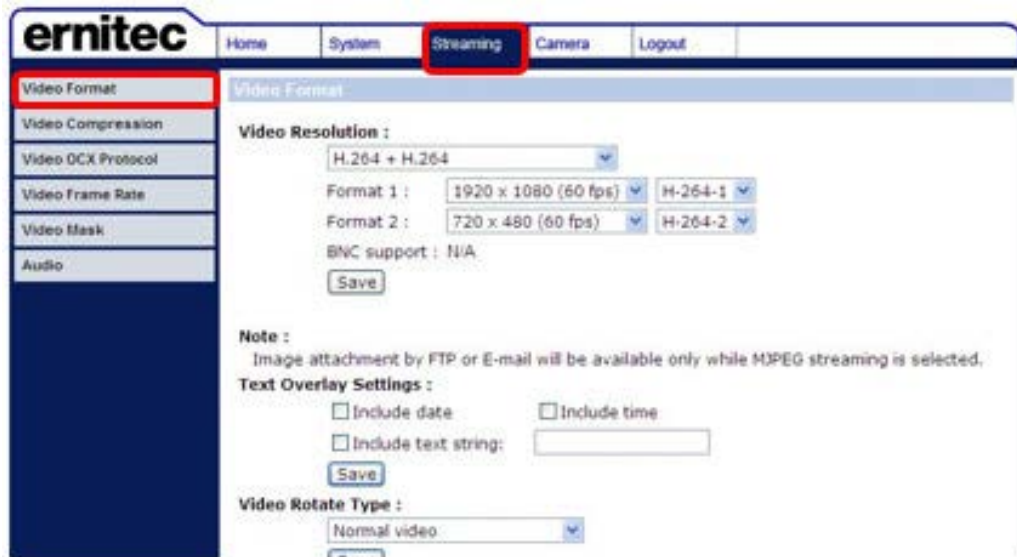

The default video resolution of 5M and 6M models are shown as below. The default resolution varies with different Fisheye Dewarping types, Front End Camera Dewarping and Back End Software Dewarping.

Users can setup the Fisheye Dewarping types on Camera setting page. Click on <Fisheye Setting> on Camera setting page, and choose a fisheye dewarping type for correcting the fisheye source images. Then, select the camera's installation method to view the dewarped images with the correct viewing modes.

<b>Front End</b>	H.264- 2080 x 2048 (20 fps) + H.264- 1920 x 1080 (20 fps)
<b>6M Back End</b>	H.264- 1920 x 1080 (60/50 fps) + H.264- 720 x 480 (60 fps) / 720 x 576 (50 fps)
<b>12M Back End</b>	H.264 4000 x 3000 (15 fps) + H.264- 1920 x 1080 (15 fps)



**NOTE:** For more details about the combinations of video resolution, please refer to the [Hyper IP Camera Menu Tree](#) in the supplied CD.

## 6. Configuration Files Export / Import

To export / import configuration files, users can access the Maintenance page on the user-friendly browser-based configuration interface.

The Maintenance setting can be found under this path: **System> Maintenance**.

Users can export configuration files to a specified location and retrieve data by uploading an existing configuration file to the camera.

### **Export**

Users can save the system settings by exporting the configuration file (.bin) to a specified location for future use. Click on the <Export> button, and the popup File Download window will come out. Click on <Save> and specify a desired location for saving the configuration file.

### **Upload**

To upload a configuration file to the camera, click on <Browse> to select the configuration file, and then click on the <Upload> button for uploading.

## 7. Tech Support Information

This chapter will introduce how to delete previously-installed Viewer in the PC and how to setup the Internet security.

### 7.1 Delete the Existing DCViewer

For users who have installed the DCViewer in the PC previously, please remove the existing DCViewer from the PC before accessing to the IP camera.

#### **Deleting the DCViewer**

In the Windows <Start Menu>, activate <Control Panel>, and then double click on <Add or Remove Programs>. In the <Currently installed programs> list, select <DCViewer> and click on the button <Remove> to uninstall the existing DCViewer.

#### **Deleting Temporary Internet Files**

To improve browser performance, it is suggested to clean up all the files in the <Temporary Internet Files>. The procedure is as follows.

**Step 1:** In the web browser, clicks on the <Tools> tab on the menu bar and select <Internet Options>.

**Step 2:** Click on the <Delete> button under <Browsing History> section. In the appeared window, tick the box beside the <Temporary Internet files>.

**Step 3:** Click on <Delete> to start deleting the files.

## 7.2 Setup Internet Security

If ActiveX control installation is blocked, please either set Internet security level to default or change ActiveX controls and plug-ins settings.

### **Internet Security Level: Default**

**Step 1:** Start the Internet Explorer (IE).

**Step 2:** Click on the <Tools> tab on the menu bar and select <Internet Options>.

**Step 3:** Click on the <Security> tab, and select <Internet> zone.

**Step 4:** Down the page, click on the <Default Level> button and click on <OK> to confirm the setting. Close the browser window, and restart a new one later to access the camera.

### **ActiveX Controls and Plug-ins Settings**

**Step 1:** Repeat **Step 1 to Step 3** of the previous section above.

**Step 2:** Down the page, click on the <Custom Level> button to change ActiveX controls and plug-ins settings. The Security Settings window will pop up.

**Step 3:** Under <ActiveX controls and plug-ins>, set **ALL** items (as listed below) to <Enable> or <Prompt>. Please note that the items vary by IE version.

#### **ActiveX controls and plug-ins settings:**

1. Binary and script behaviors.
2. Download signed ActiveX controls.
3. Download unsigned ActiveX controls.
4. Allow previously unused ActiveX controls to run without prompt.
5. Allow Scriptlets.
6. Automatic prompting for ActiveX controls.
7. Initialize and script ActiveX controls not marked as safe for scripting.
8. Run ActiveX controls and plug-ins.
9. Only allow approved domains to use ActiveX without prompt.
10. Script ActiveX controls marked safe for scripting\*.
11. Display video and animation on a webpage that does not use external media player.

**Step 4:** Click on <OK> to accept the settings. A prompt window will appear for confirming the setting changes, click <Yes(Y)> to close the Security Setting window.

**Step 5:** Click on <OK> to close the Internet Options screen.

**Step 6:** Close the browser window, and restart a new one later to access the camera.