

ernitec

Installation Guide

Mercury W301-S7

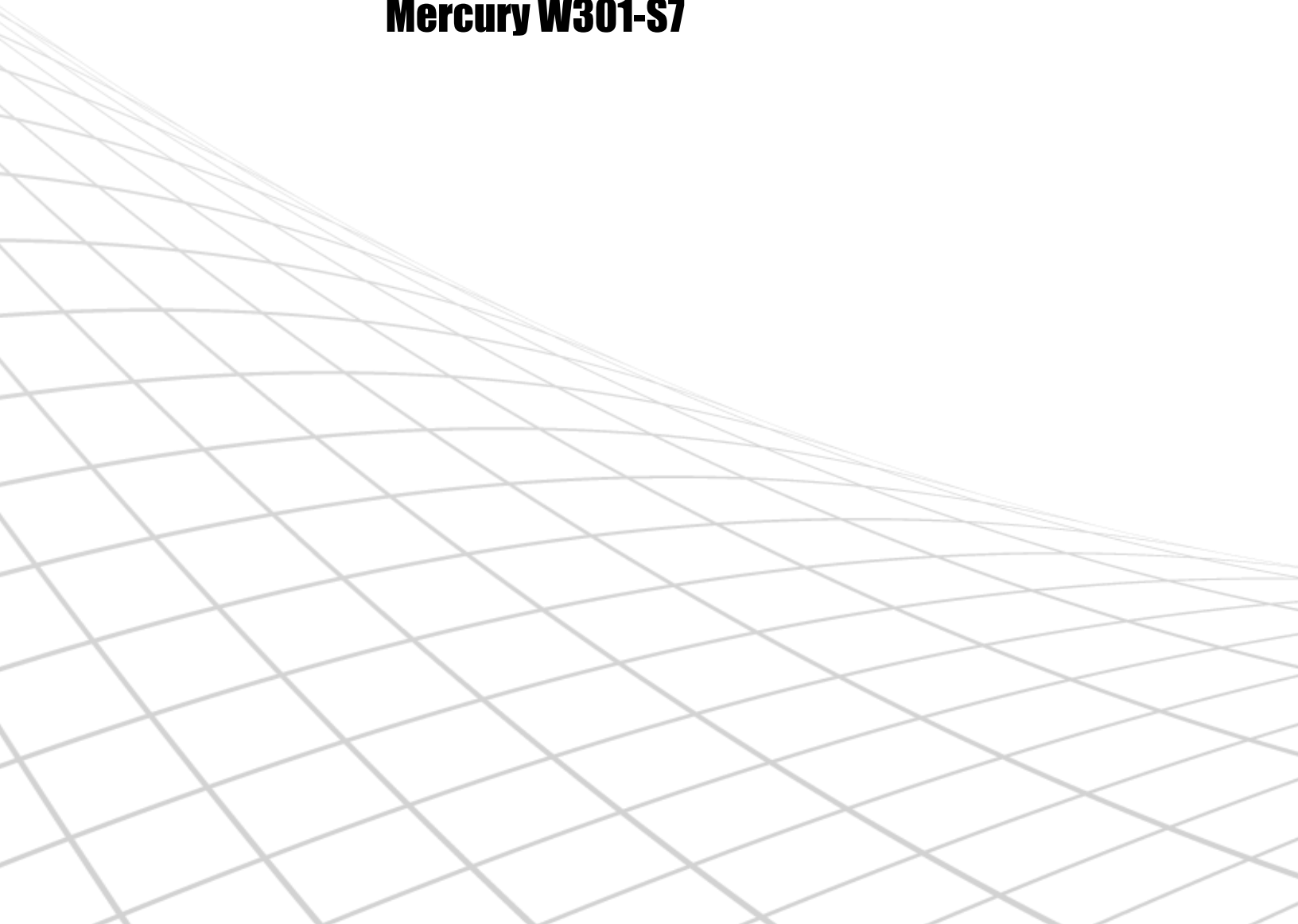

Caution and Preventive Tips

Important Information

Before proceeding, please read and observe all instructions and warnings in this manual. Retain this manual with the original bill of sale for future reference and, if necessary, warranty service. When unpacking your unit, check for missing or damaged items. If any item is missing, or if damage is evident, **DO NOT INSTALL OR OPERATE THIS PRODUCT**. Contact your dealer for assistance.

- Handle with care, do not drop the unit
- Mount the unit in an equipment rack or place it on a solid, stable surface
- Indoor use only. Do not place the unit in a humid, dusty, oily, or smoky site
- Do not place it in an area with poor ventilation or in an area close to fire or other sources of heat. Doing so may damage the unit as well as cause fire or an electric shock
- When cleaning is necessary, shut down the system and unplug the unit from the outlet before uncovering the top cover. Do not use liquid cleaners or aerosol cleaners. Use only a damp cloth for cleaning
- Always shut down the system prior connecting or disconnecting accessories, with the exception of USB devices

Copyright

Under copyright laws, the contents of this user manual may not be copied, photocopied, translated, reproduced or reduced to any electronic medium or machine-readable format, in whole or in part, without prior written permission of the company.

Important Information

Before proceeding, please read and observe all instructions and warnings in this manual. Retain this manual with the original bill of sale for future reference and, if necessary, warranty service. When unpacking your unit, check for missing or damaged items. If any item is missing, or if damage is evident, **DO NOT INSTALL OR OPERATE THIS PRODUCT**. Contact your dealer for assistance.

Regulation





	<p>This device complies with Part 15 of the FCC Rules. Operation is subject to the following two conditions: (1) this device may not cause harmful interference, and (2) this device must accept any interference received, including interference that may cause undesired operation.</p>
	<p>This symbol on the product or on its packaging indicates that this product shall not be treated as household waste in accordance with Directive 2002/96/EC. Instead it shall be handed over to the applicable collection point for the recycling of electrical and electronic equipment. By proper waste handling of this product you ensure that it has no negative consequences for the environment and human health, which could otherwise be caused if this product is thrown into the garbage bin. The recycling of materials will help to conserve natural resources.</p> <p>For more details information about recycling of this product, please contact your local city office, your household waste disposal service or the shop where you purchased the product.</p>
	<p>This symbol intends to alert the user to the presence of unprotected “Dangerous Voltage” within the product’s enclosure that may be strong enough to cause a risk of electric shock.</p>
	<p><i>This symbol intends to alert the user to the presence of important operating and maintenance (servicing) instructions in the literature accompanying the appliance.</i></p>
	<p>Compliance is evidenced by written declaration from our suppliers, assuring that any potential trace contamination levels of restricted substances are below the maximum level set by EU Directive 2002/95/EC, or are exempted due to their application.</p>

Table of Contents

<u>1. Overview</u>	4
<u>1.1 Features</u>	4
<u>1.2 Package Contents</u>	5
<u>1.3 Dimensions</u>	6
<u>1.4 Connectors (for Indoor Only)</u>	7
<u>2. Camera Cabling</u>	8
<u>2.1 Connect Power</u>	8
<u>2.2 Connect Ethernet Cable</u>	8
<u>2.3 Connect Alarm I/O</u>	9
<u>3. System Requirements</u>	10
<u>4. Access Camera</u>	11
<u>5. Setup Video Resolution</u>	15
<u>6. Configuration Files Export / Import</u>	16
<u>Appendix A: Technical Specifications</u>	17
<u>Appendix B: Delete the Existing DC Viewer</u>	19
<u>Appendix C: Setup Internet Security</u>	20
<u>Appendix D: Video Resolution</u>	21
<u>1.3M- Quad Streams (25/30 fps)</u>	21
<u>1.3M- Triple Streams (25/30 fps)</u>	32
<u>1.3M- Dual Streams (25/30 fps)</u>	37
<u>1.3M- Single Stream (25/30 fps)</u>	39
<u>1.3M- Dual Streams (50/60 fps)</u>	40
<u>1.3M- Single Stream (50/60 fps)</u>	41

1. Overview

The Ernitec Mercury W301-S7 is a compact camera with an easy setup design. High Power PoE is supported to reduce complicated cabling without sacrificing performance. Quad Streams Compression (H.264 Baseline / Main / High Profile + MJPEG) are supported for efficient bandwidth and storage management. The H.264 encoder performance is up to 1080P 60fps. Also, the product series can supply dual Full HD 1080P real-time streaming.

With more computing power, the IP Camera could provide more flexibility for users and system managers. The IP camera also supports Shutter WDR function, which can provide better image quality under extreme light contrast scenario or light changing environments.





1.1 Features

- Sony Progressive Scan CMOS Sensor
- 1.3M Resolution*
- Quad Streams Support
- Dual Streams
- Quad Streams Compression-
H.264 Baseline / Main / High Profile + MJPEG
- Multi-language Support
- Tampering Alarm
- Ultra Dynamic Range
- Motion Detection
- Privacy Masks
- 3D Noise Reduction / 2D Noise Reduction
- Network Failure Detection
- Day/Night (ICR)
- IR LED Module (working distance up to 25m)*
- Digital Image Stabilization (DIS)
- BNC Analog Output
- Weatherproof (IP66 International)*
- High Power PoE (PoE+)
- Micro SD Support
- ONVIF Support

(*) Optional

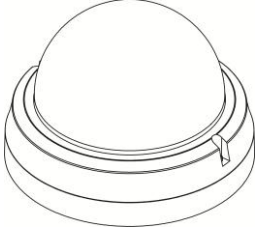
1.2 Package Contents

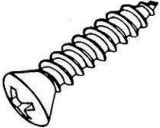
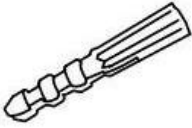
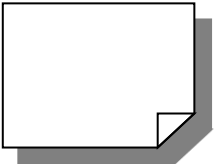
Please check the package contains the following items listed below.

 <p>Ernitec Mercury W301-S7</p>	 <p>Power Terminal Block</p>
 <p>Self Tapping Screws (x2)</p>	 <p>Plastic Screw Anchors (x2)</p>
	 <p>CD (bundled software and documentation)</p>

1.3 Dimensions

The IP Dome Camera's dimensions are shown below.

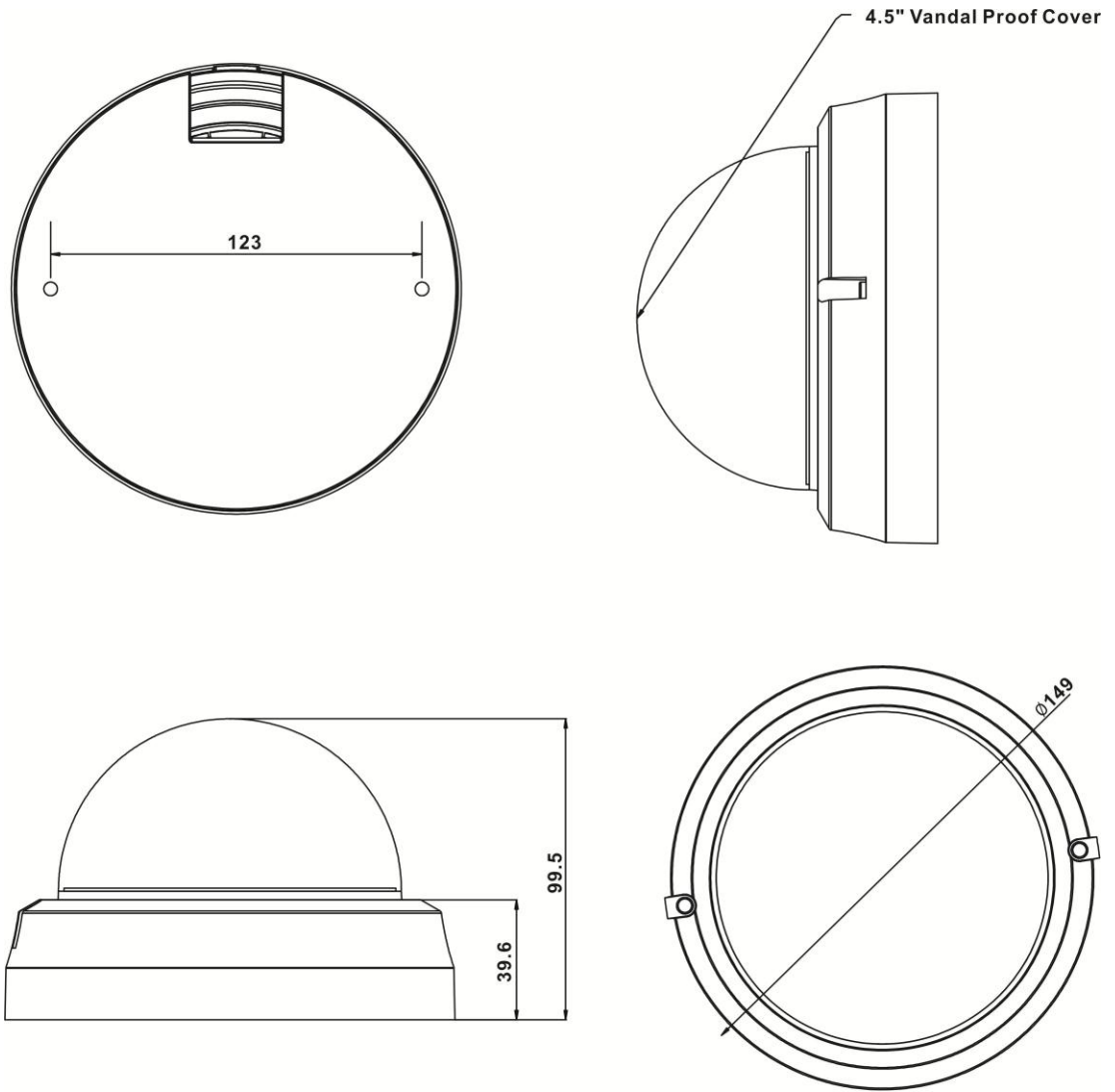

Unit: mm

1.4 Connectors

The diagram below shows the IP Camera's reset button and various connectors. Definition for each connector will be given as follows.

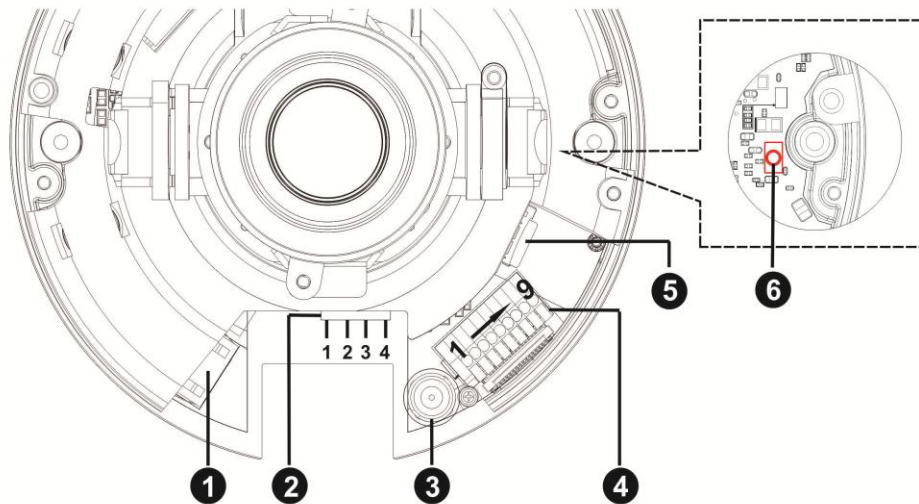

No.	Connector	Pin	Definition	Remarks	
1	RJ-45	-	10/100/1000 Mbps Ethernet / PoE		
2	Power	AC 24V	1	AC 24_1	Power connection
			2	AC 24_2	
		DC 12V	3	GND	
			4	DC 12V (+)	
3	BNC	-	Analog Video Output		
4	Alarm & Audio I/O	1	Alarm In (-)	Alarm connection	
		2	Alarm In (+)		
		3	Alarm Out (-)		
		4	Alarm Out (+)		
		5	Audio Out (R)	Line Out	
		6	Audio Out (L)		
		7	Audio GND		
		8	Audio In (R)	Line In	
9	Audio In (L)				
5	Micro SD Card Slot	-	For video recording storage		
6	Default Button	-	Press the button with a proper tool to restore the system.		

2. Camera Cabling

Please follow the instructions below to complete IP Camera connection.

2.1 Connect Power

Please refer to [Section: Connectors](#) for the indoor camera. For the outdoor camera, please refer to [Section: Function Cable Definition](#). Alternatively, connect the Ethernet Cable to the camera's PoE port and plug the other end of the cable into a PoE switch.



NOTE: If PoE is used, make sure Power Sourcing Equipment (PSE) is in used in the network.

2.2 Connect Ethernet Cable

Use of Category 5 Ethernet Cable is recommended for network connection; to have best transmission quality, cable length shall not exceed 100 meters. Connect one end of the Ethernet Cable to the RJ-45 connector of the IP Dome Camera, and the other end of the cable to the network switch or PC.



NOTE: In some cases, Ethernet Crossover Cable might be needed when connecting the IP Dome Camera directly to the PC.

Check the status of the link indicator and activity indicator LEDs. If the LEDs are unlit, please check LAN connection.

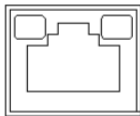

Green Link Light indicates good network connection.
Orange Activity Light flashes for network activity indication.

2.3 Connect Alarm I/O

The camera equips one alarm input and one relay output for alarm application. Refer to alarm pin definition below to connect alarm devices to the IP Camera if needed.

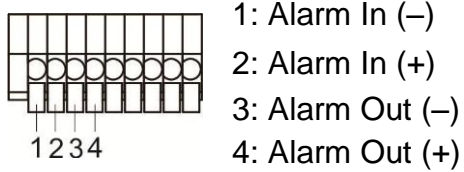

3. System Requirements

To perform the IP Camera via web browser, please ensure the PC is in good network connection, and meet system requirements as described below.

Items	System Requirement
Personal Computer	1. Intel® Pentium® M, 2.16 GHz or Intel® Core™2 Duo, 2.0 GHz 2. 2 GB RAM or more
Operating System	Windows VISTA / Windows XP / Windows 7
Web Browser	Microsoft Internet Explorer 6.0 or later Firefox Chrome Safari
Network Card	10Base-T (10 Mbps), 100Base-TX (100 Mbps) or 1000Base-T (1000 Mbps) operation
Viewer	ActiveX control plug-in for Microsoft IE

4. Access Camera

For initial access to the IP Camera, users can search the camera through the installer program: DeviceSearch.exe, which can be found in “DeviceSearch” folder in the supplied CD.

Device Search Software Setup

Step 1: Double click on the program Device Search.exe. After its window appears, click on the <Device Search> button on the top side.

Step 2: The security alert window will pop up. Click on <Unblock> to continue.

Device Search

Step 3: Click on <Device Search> again, and all the finding IP devices will be listed in the page. The IP Camera’s default IP address is: **192.168.0.250**.

Step 4: Double click or right click and select <Browse> to access the camera directly via web browser.

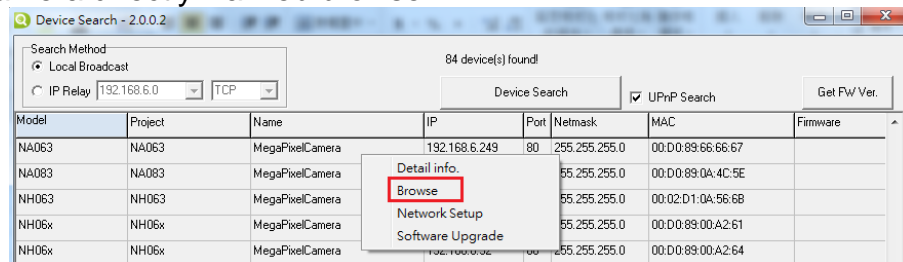

Step 5: Then the prompt window will appear to request for default username and password. Enter the default username and password shown below to log in to the IP Dome Camera.

Login ID	Password
Admin	1234



NOTE: ID and password are case sensitive.



NOTE: It is strongly advised that administrator’s password be altered for the security concerns. Refer to [Ernitec Mercury W301-S7IP Camera Menu Tree](#) for further details.

Additionally, users can change the IP Camera’s network property (DHCP or Static IP) directly in the device finding list. Refer to the following section for changing the IP Camera’s network property.

Example of Changing IP Camera's Network Property

Users can directly change an IP Camera's network property, ex. from static IP to DHCP, in the finding device list. The way to change the IP Camera's network property is specified below:

- Step 1:** In the finding device list, click on the IP Camera and change its network property. On the selected item, right click and select "Network Setup". Meanwhile, record the IP Camera's MAC address, for future identification.
- Step 2:** The "Network Setup" page will come out. Select "DHCP", and click "Apply" button down the page.
- Step 3:** Click on <OK> on the Note of setting change. Wait for one minute to re-search the IP Camera.
- Step 4:** Click on the <Device Search> button to re-search all the devices. Then select the IP Camera with the correct MAC address. Double click on the IP Camera, and the login window will come out.
- Step 5:** Enter User name and Password to access the IP Camera.

Installing DC Viewer Software Online

For the initial access to the IP Camera, a client program, DC Viewer, will be automatically installed to the PC when connecting to the IP Camera.

If the Web browser doesn't allow DC Viewer installation, please check the Internet security settings or ActiveX controls and plug-ins settings (refer to [Section: Internet Security Settings](#)) to continue the process.

The Information Bar (just below the URL bar) may come out and ask for permission to install the ActiveX Control for displaying video in browser. Right click on the Information Bar and select <Install ActiveX Control...> to allow the installation.

The download procedure of DC Viewer software is specified as follows.

Step 1: In the DC Viewer installation window, click on <Next> to start installation.

1.

Step 2: The status bar will show the installation progress. After the installation is completed, click on <Finish> to exit the installation process.

2.

Step 3: Click on <Finish> to close the DC Viewer installation page.

Once the DC Viewer is successfully installed, the IP Camera's Home page will be able to correctly display as the figure below.

➤

➤ **3x Zoom Lens Models**

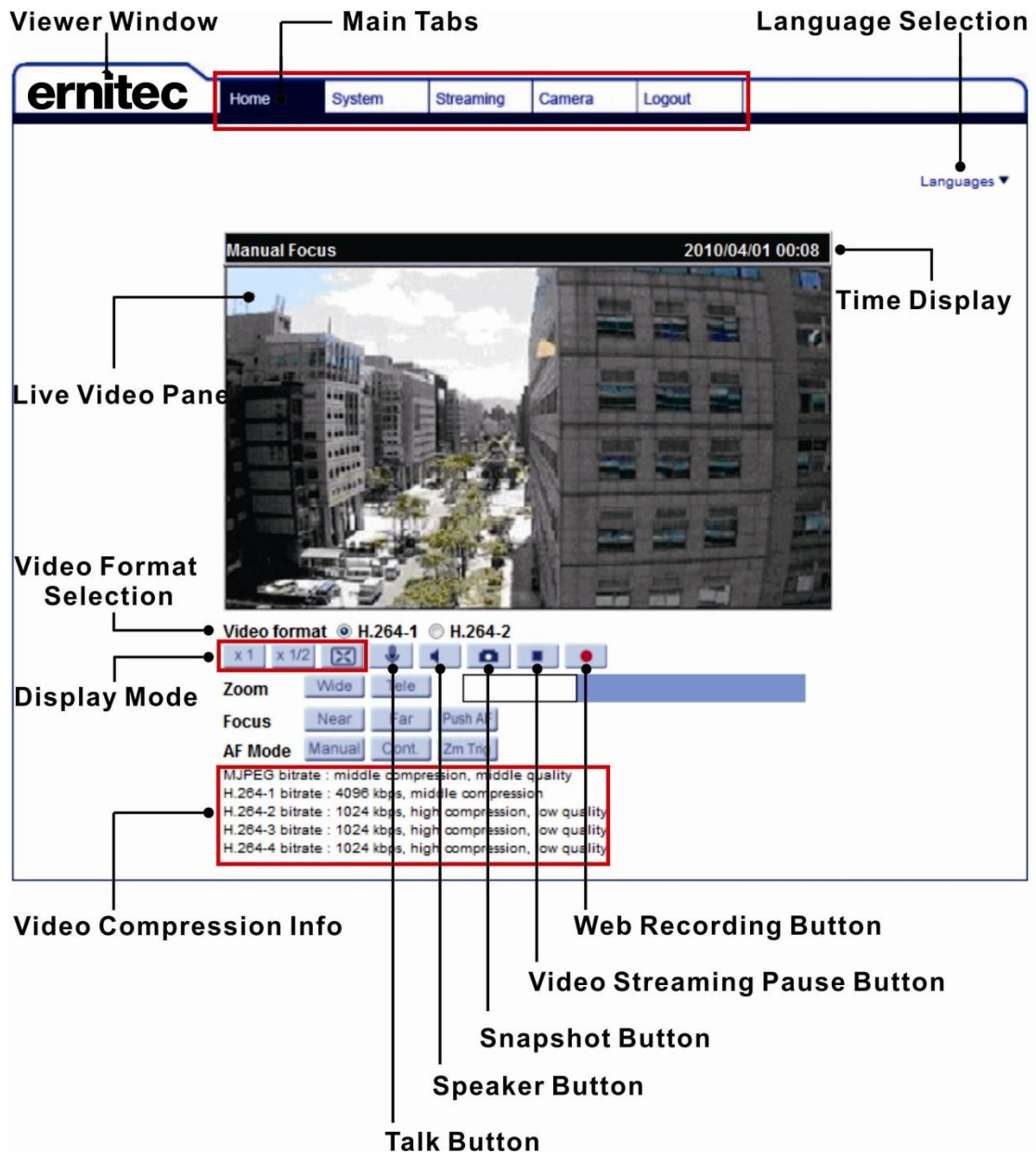

➤ **Image and Focus Adjustment**

The image will be displayed on the Home page when the IP Camera is successfully accessed. Adjust zoom and focus as necessary to produce a clear image.



NOTE: Please refer to [Ernitec Mercury W301-S7IP Camera Menu Tree](#) for more button function detail.

5. Setup Video Resolution

Users can setup Video Resolution on Video Format page of the user-friendly browser-based configuration interface.

Video Format can be found under this path: **Streaming**> **Video Format**.

The default value of Video Resolution is as below.

1.3M	720P (25/30 fps) + 720P (25/30 fps)
-------------	--

For more Video Resolution combination details, please refer to [Appendix: Video Resolution](#). Click on <Save> to confirm the setting.

6. Configuration Files Export / Import

To export / import configuration files, users can access the Maintenance page on the user-friendly browser-based configuration interface.

The Maintenance setting can be found under this path: **System> Maintenance**.

Users can export configuration files to a specified location and retrieve data by uploading an existing configuration file to the IP Camera. It is especially convenient to make multiple cameras having the same configuration.

>

> **Export**

Users can save the system settings by exporting the configuration file (.bin) to a specified location for future use. Click on the <Export> button, and the popup File Download window will come out. Click on <Save> and specify a desired location for saving the configuration file.

> **Upload**

To copy an existing configuration file to the IP Camera, please first click on <Browse> to select the configuration file, and then click on the <Upload> button for uploading.

Appendix A: Technical Specifications

Camera		1.3M
Image Sensor		1/3" Sony Progressive CMOS
Effective Pixels		1280 (H) x 1024 (V)
Minimum Illumination		TBD
Shutter Speed		1 ~ 1/10000 sec.
Lens		
Lens		3x Zoom
Focal Length		3 ~ 9 mm
F Number		3x Zoom: F 1.2 (Wide); F 2.1 (Tele)
FOV		3x Zoom: 92.93° (Wide); 30.9° (Tele)
Operation		
Multiple Languages		English / French / German / Italian / Japanese / Korean / Portuguese / Russian / Simplified Chinese / Spanish / Traditional Chinese
Image Setting	Backlight Compensation	On / Off
	White Balance	Auto / Manual / ATW
	Noise Reduction (3D / 2D)	On / Off
	Wide Dynamic Range	Shutter WDR (130dB)
	Privacy Mask	On / Off
	Brightness	Manual
	Exposure	Auto / Manual
	Sharpness	Manual
	Contrast	Manual
	Saturation	Manual
	Hue	Manual
	Digital Zoom	Support
	Motion Detection	On / Off / By Schedule
	Privacy Mask Type	Color
	ICR	Auto / On / Off / Smart
	ICR + IR LED*	Auto / LED On / LED Off / Light Sensor
Tampering Alarm	On / Off / By Schedule	
Digital Image Stabilization (DIS)	On / Off	
Audio	Two-way Audio	Line In / Line Out
	Compression	G.711 / G.726
Network		
Interface		RJ-45, 10/100/1000 Mbps Ethernet (Giga Ethernet)
Video Compression		H.264 / MJPEG
Video Streaming	Dual Streams	H.264 720P (50/60 fps) + H.264 / MJPEG SVGA (50/60 fps)
	Quad Streams	H.264 SXGA (25/30 fps) + H.264 720P (25/30 fps) + H.264 SVGA (25/30 fps) + H.264 / MJPEG CIF (25/30 fps)
Video Resolution		SXGA / HD 720P / XGA / SVGA / D1 / VGA / CIF / QCIF @ 50/60 fps (2 Shutter WDR) or 25/30 fps (4 Shutter WDR)
Protocol		IPv4/v6, TCP/IP, UDP, RTP, RTSP, HTTP, HTTPS, ICMP, FTP, SMTP, DHCP, PPPoE, UPnP, IGMP, SNMP, QoS, ONVIF
Security		HTTPS / IP Filter / IEEE 802.1x
Alarm	Input	1 Set, 5V 10kΩ pull up
	Output	1 Set, Photo Relay Output 300V DC/AC
Event Notification		HTTP / FTP / SMTP
Micro SD		microSDHC 32GB support
Supported Web Browser		Internet Explorer (6.0+) / Chrome / Firefox / Safari
User Account		20
Password Levels		User and Administrator

Mechanical		
LED Indicator		Power / Link / ACT
Connectors	Alarm	4 of 9 Pin Terminal Block
	Power	4 Pin Terminal Block
	Ethernet	RJ-45
	Analog Video	1.0 Vp-p / 75Ω, BNC
	Audio*	5 of 9 Pin Terminal Block
General		
Operating Temperature		TBD
Humidity		TBD
Weatherproof Standard*		IP66
Dimension		∅ 149 x 99.53 mm
Weight		TBD
Power Source		DC 12V / AC 24V / PoE+
Power Consumption	System	3x Zoom: 7.0W
	Zoom / Focus Moving	+1.3W
	ICR Switching	+0.5W
	*Heater	+10.0W
Regulatory		CE / FCC / RoHS

(*) Optional

Appendix B: Delete the Existing DC Viewer

For users who have installed the DC Viewer in the PC previously, please remove the existing DC Viewer from the PC before accessing to the IP Camera.

Deleting the DC Viewer

In the Windows <Start Menu>, activate <Control Panel>, and then double click on <Add or Remove Programs>. In the <Currently installed programs> list, select <DCViewer> and click on the button <Remove> to uninstall the existing DC Viewer.

Deleting Temporary Internet Files

To improve browser performance, it is suggested to clean up all the files in the Temporary Internet Files.

The procedure is as follows:

Step 1: Click on the <Tools> tab on the menu bar and select <Internet Options>.

3.

Step 2: Click on the <Delete> button under <Browsing history> section. Then click on the <Delete Files> button under the <Temporary Internet files> section.

Step 3: A confirmation window will pop up. Click on <Yes> to start deleting the files.

Appendix C: Setup Internet Security

If ActiveX control installation is blocked, please either set Internet security level to default or change ActiveX controls and plug-ins settings.

Internet Security Level: Default

Step 1: Start the Internet Explorer (IE).

Step 2: Click on the <Tools> tab on the menu bar and select <Internet Options>.

Step 3: Click on the <Security> tab, and select <Internet> zone.

Step 4: Down the page, click on the <Default Level> button and click on <OK> to confirm the setting. Close the browser window, and restart a new one later to access the IP Camera.

ActiveX Controls and Plug-ins Settings

Step 1: Repeat **Steps 1~3** of the previous section above.

Step 2: Down the page, click on the <Custom Level> button to change ActiveX controls and plug-ins settings. The Security Settings window will pop up.

Step 3: Under <ActiveX controls and plug-ins>, set **ALL** items (as listed below) to <Enable> or <Prompt>. Please note that the items vary by IE version.

ActiveX controls and plug-ins settings:

4. Allow previously unused ActiveX controls to run without prompt.
5. Allow Scriptlets.
6. Automatic prompting for ActiveX controls.
7. Binary and script behaviors.
8. Display video and animation on a webpage that does not use external media player.
9. Download signed ActiveX controls.
10. Download unsigned ActiveX controls.
11. Initialize and script ActiveX controls not marked as safe for scripting.
12. Run ActiveX controls and plug-ins.
13. Script ActiveX controls marked safe for scripting.

Step 4: Click on <OK> to accept the settings and close the Security Settings window.

Step 5: Click on <OK> to close the Internet Options screen.

Step 6: Close the browser window, and restart a new one later to access the IP Camera.

Appendix D: Video Resolution

1.3M- Quad Streams (25/30 fps)

H.264 + H.264 + H.264 + H.264				
H.264-1	H.264-2	H.264-3	H.264-4	
1280 x 1024 (13/15 fps)	1280 x 1024 (25/30 fps)	1024 x 768 (25/30 fps)	176 x 120 (25/30 fps)	
		800 x 600 (25/30 fps)	720 x 480 (25/30 fps)	
			640 x 480 (25/30 fps)	
			352 x 240 (25/30 fps)	
			176 x 120 (25/30 fps)	
		720 x 480 (25/30 fps)	720 x 480 (25/30 fps)	
			640 x 480 (25/30 fps)	
			352 x 240 (25/30 fps)	
		640 x 480 (25/30 fps)	640 x 480 (25/30 fps)	
			352 x 240 (25/30 fps)	
352 x 240 (25/30 fps)	352 x 240 (25/30 fps)			
176 x 120 (25/30 fps)	176 x 120 (25/30 fps)			
1280 x 1024 (25/30 fps)	1280 x 720 (25/30 fps)	800 x 600 (25/30 fps)	352 x 240 (25/30 fps)	
		720 x 480 (25/30 fps)	176 x 120 (25/30 fps)	
			720 x 480 (25/30 fps)	
			640 x 480 (25/30 fps)	
			352 x 240 (25/30 fps)	
		640 x 480 (25/30 fps)	640 x 480 (25/30 fps)	
			352 x 240 (25/30 fps)	
			176 x 120 (25/30 fps)	
		352 x 240 (25/30 fps)	352 x 240 (25/30 fps)	
			176 x 120 (25/30 fps)	
	176 x 120 (25/30 fps)	176 x 120 (25/30 fps)		
	1024 x 768 (25/30 fps)	1024 x 768 (25/30 fps)	720 x 480 (25/30 fps)	720 x 480 (25/30 fps)
				640 x 480 (25/30 fps)
				352 x 240 (25/30 fps)
				176 x 120 (25/30 fps)
			640 x 480 (25/30 fps)	640 x 480 (25/30 fps)
				352 x 240 (25/30 fps)
				176 x 120 (25/30 fps)
			352 x 240 (25/30 fps)	352 x 240 (25/30 fps)
				176 x 120 (25/30 fps)
176 x 120 (25/30 fps)			176 x 120 (25/30 fps)	
800 x 600 (25/30 fps)	800 x 600 (25/30 fps)	800 x 600 (25/30 fps)	800 x 600 (25/30 fps)	
			720 x 480 (25/30 fps)	
			640 x 480 (25/30 fps)	
			352 x 240 (25/30 fps)	
			176 x 120 (25/30 fps)	
		720 x 480 (25/30 fps)	720 x 480 (25/30 fps)	
			640 x 480 (25/30 fps)	
			352 x 240 (25/30 fps)	
		640 x 480 (25/30 fps)	640 x 480 (25/30 fps)	
			352 x 240 (25/30 fps)	

H.264 + H.264 + H.264 + H.264					
H.264-1	H.264-2	H.264-3	H.264-4		
			176 x 120 (25/30 fps)		
		352 x 240 (25/30 fps)	352 x 240 (25/30 fps)		
		176 x 120 (25/30 fps)	176 x 120 (25/30 fps)		
		176 x 120 (25/30 fps)	176 x 120 (25/30 fps)		
	720 x 480 (25/30 fps)	720 x 480 (25/30 fps)		720 x 480 (25/30 fps)	
				640 x 480 (25/30 fps)	
				352 x 240 (25/30 fps)	
				176 x 120 (25/30 fps)	
		640 x 480 (25/30 fps)	640 x 480 (25/30 fps)		640 x 480 (25/30 fps)
					352 x 240 (25/30 fps)
	640 x 480 (25/30 fps)	352 x 240 (25/30 fps)		352 x 240 (25/30 fps)	
				176 x 120 (25/30 fps)	
		176 x 120 (25/30 fps)		176 x 120 (25/30 fps)	
				176 x 120 (25/30 fps)	
	352 x 240 (25/30 fps)	352 x 240 (25/30 fps)		352 x 240 (25/30 fps)	
				176 x 120 (25/30 fps)	
176 x 120 (25/30 fps)			176 x 120 (25/30 fps)		
			176 x 120 (25/30 fps)		
176 x 120 (25/30 fps)		176 x 120 (25/30 fps)	176 x 120 (25/30 fps)		
		176 x 120 (25/30 fps)	176 x 120 (25/30 fps)		
		176 x 120 (25/30 fps)	176 x 120 (25/30 fps)		
		176 x 120 (25/30 fps)	176 x 120 (25/30 fps)		
1280 x 720 (25/30 fps)	1280 x 720 (25/30 fps)	1280 x 720 (25/30 fps)	352 x 240 (25/30 fps)		
			176 x 120 (25/30 fps)		
		1024 x 768 (25/30 fps)	352 x 240 (25/30 fps)		
			176 x 120 (25/30 fps)		
		800 x 600 (25/30 fps)	800 x 600 (25/30 fps)		800 x 600 (25/30 fps)
					720 x 480 (25/30 fps)
					640 x 480 (25/30 fps)
					352 x 240 (25/30 fps)
		720 x 480 (25/30 fps)	720 x 480 (25/30 fps)		176 x 120 (25/30 fps)
					720 x 480 (25/30 fps)
					640 x 480 (25/30 fps)
					352 x 240 (25/30 fps)
	640 x 480 (25/30 fps)	640 x 480 (25/30 fps)		176 x 120 (25/30 fps)	
				640 x 480 (25/30 fps)	
				352 x 240 (25/30 fps)	
				176 x 120 (25/30 fps)	
	352 x 240 (25/30 fps)	352 x 240 (25/30 fps)		352 x 240 (25/30 fps)	
				176 x 120 (25/30 fps)	
		176 x 120 (25/30 fps)		176 x 120 (25/30 fps)	
				176 x 120 (25/30 fps)	
	1024 x 768 (25/30 fps)	1024 x 768 (25/30 fps)		720 x 480 (25/30 fps)	
				640 x 480 (25/30 fps)	
				352 x 240 (25/30 fps)	
				176 x 120 (25/30 fps)	
800 x 600 (25/30 fps)		800 x 600 (25/30 fps)		800 x 600 (25/30 fps)	
				720 x 480 (25/30 fps)	
				640 x 480 (25/30 fps)	
				352 x 240 (25/30 fps)	
720 x 480 (25/30 fps)		720 x 480 (25/30 fps)		176 x 120 (25/30 fps)	
				720 x 480 (25/30 fps)	
				640 x 480 (25/30 fps)	
				352 x 240 (25/30 fps)	
640 x 480 (25/30 fps)	640 x 480 (25/30 fps)		176 x 120 (25/30 fps)		
			640 x 480 (25/30 fps)		
	176 x 120 (25/30 fps)		176 x 120 (25/30 fps)		
			176 x 120 (25/30 fps)		

H.264 + H.264 + H.264 + H.264					
H.264-1	H.264-2	H.264-3	H.264-4		
		352 x 240 (25/30 fps)	352 x 240 (25/30 fps)		
			176 x 120 (25/30 fps)		
			352 x 240 (25/30 fps)		
			176 x 120 (25/30 fps)		
	800 x 600 (25/30 fps)	176 x 120 (25/30 fps)	800 x 600 (25/30 fps)	176 x 120 (25/30 fps)	
				800 x 600 (25/30 fps)	
		800 x 600 (25/30 fps)	720 x 480 (25/30 fps)	720 x 480 (25/30 fps)	720 x 480 (25/30 fps)
					720 x 480 (25/30 fps)
					640 x 480 (25/30 fps)
					352 x 240 (25/30 fps)
		800 x 600 (25/30 fps)	640 x 480 (25/30 fps)	640 x 480 (25/30 fps)	176 x 120 (25/30 fps)
					640 x 480 (25/30 fps)
					352 x 240 (25/30 fps)
					176 x 120 (25/30 fps)
		800 x 600 (25/30 fps)	352 x 240 (25/30 fps)	352 x 240 (25/30 fps)	176 x 120 (25/30 fps)
					352 x 240 (25/30 fps)
					176 x 120 (25/30 fps)
					176 x 120 (25/30 fps)
		720 x 480 (25/30 fps)	720 x 480 (25/30 fps)	720 x 480 (25/30 fps)	720 x 480 (25/30 fps)
					640 x 480 (25/30 fps)
	352 x 240 (25/30 fps)				
	176 x 120 (25/30 fps)				
	720 x 480 (25/30 fps)		640 x 480 (25/30 fps)	640 x 480 (25/30 fps)	640 x 480 (25/30 fps)
					352 x 240 (25/30 fps)
					176 x 120 (25/30 fps)
					176 x 120 (25/30 fps)
	640 x 480 (25/30 fps)	640 x 480 (25/30 fps)	640 x 480 (25/30 fps)	640 x 480 (25/30 fps)	
				352 x 240 (25/30 fps)	
				176 x 120 (25/30 fps)	
				176 x 120 (25/30 fps)	
	640 x 480 (25/30 fps)	352 x 240 (25/30 fps)	352 x 240 (25/30 fps)	352 x 240 (25/30 fps)	
				176 x 120 (25/30 fps)	
				176 x 120 (25/30 fps)	
	352 x 240 (25/30 fps)	352 x 240 (25/30 fps)	352 x 240 (25/30 fps)	352 x 240 (25/30 fps)	
				176 x 120 (25/30 fps)	
	176 x 120 (25/30 fps)	176 x 120 (25/30 fps)	176 x 120 (25/30 fps)	176 x 120 (25/30 fps)	
	1024 x 768 (25/30 fps)	1024 x 768 (25/30 fps)	1024 x 768 (25/30 fps)	800 x 600 (25/30 fps)	
				720 x 480 (25/30 fps)	
				640 x 480 (25/30 fps)	
				352 x 240 (25/30 fps)	
176 x 120 (25/30 fps)					
1024 x 768 (25/30 fps)		800 x 600 (25/30 fps)	800 x 600 (25/30 fps)	800 x 600 (25/30 fps)	
				720 x 480 (25/30 fps)	
				640 x 480 (25/30 fps)	
				352 x 240 (25/30 fps)	
				176 x 120 (25/30 fps)	
1024 x 768 (25/30 fps)		720 x 480 (25/30 fps)	720 x 480 (25/30 fps)	720 x 480 (25/30 fps)	
				640 x 480 (25/30 fps)	
				352 x 240 (25/30 fps)	
				176 x 120 (25/30 fps)	
1024 x 768 (25/30 fps)		640 x 480 (25/30 fps)	640 x 480 (25/30 fps)	640 x 480 (25/30 fps)	
				352 x 240 (25/30 fps)	
	176 x 120 (25/30 fps)				

H.264 + H.264 + H.264 + H.264						
H.264-1	H.264-2	H.264-3	H.264-4			
		352 x 240 (25/30 fps)	352 x 240 (25/30 fps) 176 x 120 (25/30 fps)			
		176 x 120 (25/30 fps)	176 x 120 (25/30 fps)			
	800 x 600 (25/30 fps)	800 x 600 (25/30 fps)	800 x 600 (25/30 fps)	800 x 600 (25/30 fps) 720 x 480 (25/30 fps) 640 x 480 (25/30 fps) 352 x 240 (25/30 fps) 176 x 120 (25/30 fps)		
				720 x 480 (25/30 fps)	720 x 480 (25/30 fps) 640 x 480 (25/30 fps) 352 x 240 (25/30 fps) 176 x 120 (25/30 fps)	
					640 x 480 (25/30 fps)	640 x 480 (25/30 fps) 352 x 240 (25/30 fps) 176 x 120 (25/30 fps)
						352 x 240 (25/30 fps) 176 x 120 (25/30 fps)
				720 x 480 (25/30 fps)	720 x 480 (25/30 fps)	720 x 480 (25/30 fps)
		640 x 480 (25/30 fps)	640 x 480 (25/30 fps) 352 x 240 (25/30 fps) 176 x 120 (25/30 fps)			
			352 x 240 (25/30 fps)		352 x 240 (25/30 fps) 176 x 120 (25/30 fps)	
					176 x 120 (25/30 fps)	176 x 120 (25/30 fps)
		640 x 480 (25/30 fps)	640 x 480 (25/30 fps)		640 x 480 (25/30 fps)	640 x 480 (25/30 fps) 352 x 240 (25/30 fps) 176 x 120 (25/30 fps)
				352 x 240 (25/30 fps)		352 x 240 (25/30 fps) 176 x 120 (25/30 fps)
	176 x 120 (25/30 fps)		176 x 120 (25/30 fps)			
			176 x 120 (25/30 fps)	176 x 120 (25/30 fps)		
	800 x 600 (25/30 fps)	800 x 600 (25/30 fps)	800 x 600 (25/30 fps)	800 x 600 (25/30 fps) 720 x 480 (25/30 fps) 640 x 480 (25/30 fps) 352 x 240 (25/30 fps) 176 x 120 (25/30 fps)		
				720 x 480 (25/30 fps)	720 x 480 (25/30 fps) 640 x 480 (25/30 fps) 352 x 240 (25/30 fps) 176 x 120 (25/30 fps)	
					640 x 480 (25/30 fps)	640 x 480 (25/30 fps) 352 x 240 (25/30 fps) 176 x 120 (25/30 fps)
						352 x 240 (25/30 fps) 176 x 120 (25/30 fps)
				720 x 480 (25/30 fps)	720 x 480 (25/30 fps)	720 x 480 (25/30 fps)
		640 x 480 (25/30 fps)	640 x 480 (25/30 fps) 352 x 240 (25/30 fps) 176 x 120 (25/30 fps)			
			352 x 240 (25/30 fps)		352 x 240 (25/30 fps) 176 x 120 (25/30 fps)	
					176 x 120 (25/30 fps)	176 x 120 (25/30 fps)

H.264 + H.264 + H.264 + H.264				
H.264-1	H.264-2	H.264-3	H.264-4	
		640 x 480 (25/30 fps)	640 x 480 (25/30 fps)	
			352 x 240 (25/30 fps)	
			176 x 120 (25/30 fps)	
		352 x 240 (25/30 fps)	176 x 120 (25/30 fps)	352 x 240 (25/30 fps)
				176 x 120 (25/30 fps)
				176 x 120 (25/30 fps)
	640 x 480 (25/30 fps)	640 x 480 (25/30 fps)	640 x 480 (25/30 fps)	
			352 x 240 (25/30 fps)	
			176 x 120 (25/30 fps)	
		352 x 240 (25/30 fps)	176 x 120 (25/30 fps)	352 x 240 (25/30 fps)
				176 x 120 (25/30 fps)
				176 x 120 (25/30 fps)
352 x 240 (25/30 fps)	176 x 120 (25/30 fps)	352 x 240 (25/30 fps)		
		176 x 120 (25/30 fps)		
		176 x 120 (25/30 fps)		
176 x 120 (25/30 fps)	176 x 120 (25/30 fps)	176 x 120 (25/30 fps)		
		176 x 120 (25/30 fps)		
		176 x 120 (25/30 fps)		

H.264 + H.264 + H.264 + H.264					
H.264-1	H.264-2	H.264-3	H.264-4		
720 x 480 (25/30 fps)	720 x 480 (25/30 fps)	720 x 480 (25/30 fps)	720 x 480 (25/30 fps)		
			640 x 480 (25/30 fps)		
			352 x 240 (25/30 fps)		
		640 x 480 (25/30 fps)	640 x 480 (25/30 fps)	640 x 480 (25/30 fps)	
				352 x 240 (25/30 fps)	
				176 x 120 (25/30 fps)	
			352 x 240 (25/30 fps)	176 x 120 (25/30 fps)	352 x 240 (25/30 fps)
					176 x 120 (25/30 fps)
					176 x 120 (25/30 fps)
	640 x 480 (25/30 fps)	640 x 480 (25/30 fps)	640 x 480 (25/30 fps)		
			352 x 240 (25/30 fps)		
			176 x 120 (25/30 fps)		
		352 x 240 (25/30 fps)	176 x 120 (25/30 fps)	352 x 240 (25/30 fps)	
				176 x 120 (25/30 fps)	
				176 x 120 (25/30 fps)	
		176 x 120 (25/30 fps)	176 x 120 (25/30 fps)	176 x 120 (25/30 fps)	
				176 x 120 (25/30 fps)	
				176 x 120 (25/30 fps)	
640 x 480 (25/30 fps)	640 x 480 (25/30 fps)		640 x 480 (25/30 fps)		
			352 x 240 (25/30 fps)		
			176 x 120 (25/30 fps)		
	352 x 240 (25/30 fps)	176 x 120 (25/30 fps)	352 x 240 (25/30 fps)		
			176 x 120 (25/30 fps)		
			176 x 120 (25/30 fps)		
176 x 120 (25/30 fps)	176 x 120 (25/30 fps)	176 x 120 (25/30 fps)			
		176 x 120 (25/30 fps)			
		176 x 120 (25/30 fps)			

H.264 + H.264 + H.264 + H.264			
H.264-1	H.264-2	H.264-3	H.264-4
352 x 240 (25/30 fps)	352 x 240 (25/30 fps)	352 x 240 (25/30 fps)	352 x 240 (25/30 fps)
		176 x 120 (25/30 fps)	176 x 120 (25/30 fps)
176 x 120 (25/30 fps)	176 x 120 (25/30 fps)	176 x 120 (25/30 fps)	176 x 120 (25/30 fps)
	176 x 120 (25/30 fps)	176 x 120 (25/30 fps)	176 x 120 (25/30 fps)

*BNC is not supported.

H.264 + H.264 + H.264 + MJPEG					
H.264-1	H.264-2	H.264-3	MJPEG		
1280 x 1024 (13/15 fps)	1280 x 1024 (25/30 fps)	1024 x 768 (25/30 fps)	176 x 120 (25/30 fps)		
		800 x 600 (25/30 fps)	720 x 480 (25/30 fps)	720 x 480 (25/30 fps)	
			720 x 480 (25/30 fps)	640 x 480 (25/30 fps)	640 x 480 (25/30 fps)
				352 x 240 (25/30 fps)	352 x 240 (25/30 fps)
				176 x 120 (25/30 fps)	176 x 120 (25/30 fps)
		640 x 480 (25/30 fps)	720 x 480 (25/30 fps)	720 x 480 (25/30 fps)	
			352 x 240 (25/30 fps)	640 x 480 (25/30 fps)	640 x 480 (25/30 fps)
				352 x 240 (25/30 fps)	352 x 240 (25/30 fps)
				176 x 120 (25/30 fps)	176 x 120 (25/30 fps)
		1280 x 1024 (25/30 fps)	1280 x 720 (25/30 fps)	800 x 600 (25/30 fps)	352 x 240 (25/30 fps)
720 x 480 (25/30 fps)	176 x 120 (25/30 fps)			176 x 120 (25/30 fps)	
	640 x 480 (25/30 fps)			720 x 480 (25/30 fps)	720 x 480 (25/30 fps)
				640 x 480 (25/30 fps)	640 x 480 (25/30 fps)
				352 x 240 (25/30 fps)	352 x 240 (25/30 fps)
352 x 240 (25/30 fps)	352 x 240 (25/30 fps)		352 x 240 (25/30 fps)		
	176 x 120 (25/30 fps)		176 x 120 (25/30 fps)		
	176 x 120 (25/30 fps)		176 x 120 (25/30 fps)		
1024 x 768 (25/30 fps)	1024 x 768 (25/30 fps)		720 x 480 (25/30 fps)	720 x 480 (25/30 fps)	
				640 x 480 (25/30 fps)	
		352 x 240 (25/30 fps)			
		176 x 120 (25/30 fps)			

H.264 + H.264 + H.264 + MJPEG					
H.264-1	H.264-2	H.264-3	MJPEG		
		640 x 480 (25/30 fps)	640 x 480 (25/30 fps)		
			352 x 240 (25/30 fps)		
			176 x 120 (25/30 fps)		
			352 x 240 (25/30 fps)	176 x 120 (25/30 fps)	352 x 240 (25/30 fps)
					176 x 120 (25/30 fps)
					176 x 120 (25/30 fps)
	800 x 600 (25/30 fps)		800 x 600 (25/30 fps)		800 x 600 (25/30 fps)
					720 x 480 (25/30 fps)
					640 x 480 (25/30 fps)
		352 x 240 (25/30 fps)			
		176 x 120 (25/30 fps)			
		176 x 120 (25/30 fps)			
		720 x 480 (25/30 fps)	720 x 480 (25/30 fps)		720 x 480 (25/30 fps)
					640 x 480 (25/30 fps)
					352 x 240 (25/30 fps)
					176 x 120 (25/30 fps)
					176 x 120 (25/30 fps)
					176 x 120 (25/30 fps)
	640 x 480 (25/30 fps)	640 x 480 (25/30 fps)		640 x 480 (25/30 fps)	
				352 x 240 (25/30 fps)	
				176 x 120 (25/30 fps)	
				176 x 120 (25/30 fps)	
				176 x 120 (25/30 fps)	
				176 x 120 (25/30 fps)	
352 x 240 (25/30 fps)	352 x 240 (25/30 fps)		352 x 240 (25/30 fps)		
			176 x 120 (25/30 fps)		
			176 x 120 (25/30 fps)		
176 x 120 (25/30 fps)	176 x 120 (25/30 fps)		176 x 120 (25/30 fps)		
			176 x 120 (25/30 fps)		
			176 x 120 (25/30 fps)		
1280 x 720 (25/30 fps)	1280 x 720 (25/30 fps)	1280 x 720 (25/30 fps)	352 x 240 (25/30 fps)		
			176 x 120 (25/30 fps)		
		1024 x 768 (25/30 fps)		352 x 240 (25/30 fps)	
				176 x 120 (25/30 fps)	
		800 x 600 (25/30 fps)		800 x 600 (25/30 fps)	
				720 x 480 (25/30 fps)	
				640 x 480 (25/30 fps)	
				352 x 240 (25/30 fps)	
				176 x 120 (25/30 fps)	
				176 x 120 (25/30 fps)	
		720 x 480 (25/30 fps)		720 x 480 (25/30 fps)	
				640 x 480 (25/30 fps)	
				352 x 240 (25/30 fps)	
				176 x 120 (25/30 fps)	
				176 x 120 (25/30 fps)	
				176 x 120 (25/30 fps)	
		640 x 480 (25/30 fps)		640 x 480 (25/30 fps)	
				352 x 240 (25/30 fps)	
176 x 120 (25/30 fps)					
176 x 120 (25/30 fps)					
176 x 120 (25/30 fps)					
176 x 120 (25/30 fps)					

H.264 + H.264 + H.264 + MJPEG						
H.264-1	H.264-2	H.264-3	MJPEG			
		352 x 240 (25/30 fps)	352 x 240 (25/30 fps)			
		176 x 120 (25/30 fps)	176 x 120 (25/30 fps)			
	1024 x 768 (25/30 fps)	1024 x 768 (25/30 fps)	720 x 480 (25/30 fps)	720 x 480 (25/30 fps)		
			640 x 480 (25/30 fps)	640 x 480 (25/30 fps)		
		800 x 600 (25/30 fps)	800 x 600 (25/30 fps)	352 x 240 (25/30 fps)	352 x 240 (25/30 fps)	
				176 x 120 (25/30 fps)	176 x 120 (25/30 fps)	
			720 x 480 (25/30 fps)	720 x 480 (25/30 fps)	800 x 600 (25/30 fps)	800 x 600 (25/30 fps)
					640 x 480 (25/30 fps)	640 x 480 (25/30 fps)
		800 x 600 (25/30 fps)	800 x 600 (25/30 fps)	352 x 240 (25/30 fps)	352 x 240 (25/30 fps)	
				176 x 120 (25/30 fps)	176 x 120 (25/30 fps)	
			720 x 480 (25/30 fps)	720 x 480 (25/30 fps)	800 x 600 (25/30 fps)	800 x 600 (25/30 fps)
					640 x 480 (25/30 fps)	640 x 480 (25/30 fps)
	720 x 480 (25/30 fps)		720 x 480 (25/30 fps)	352 x 240 (25/30 fps)	352 x 240 (25/30 fps)	
				176 x 120 (25/30 fps)	176 x 120 (25/30 fps)	
		640 x 480 (25/30 fps)	640 x 480 (25/30 fps)	800 x 600 (25/30 fps)	800 x 600 (25/30 fps)	
				640 x 480 (25/30 fps)	640 x 480 (25/30 fps)	
	640 x 480 (25/30 fps)	640 x 480 (25/30 fps)	352 x 240 (25/30 fps)	352 x 240 (25/30 fps)		
			176 x 120 (25/30 fps)	176 x 120 (25/30 fps)		
		352 x 240 (25/30 fps)	352 x 240 (25/30 fps)	800 x 600 (25/30 fps)	800 x 600 (25/30 fps)	
				640 x 480 (25/30 fps)	640 x 480 (25/30 fps)	
		176 x 120 (25/30 fps)	176 x 120 (25/30 fps)	720 x 480 (25/30 fps)	720 x 480 (25/30 fps)	
				640 x 480 (25/30 fps)	640 x 480 (25/30 fps)	
		352 x 240 (25/30 fps)	352 x 240 (25/30 fps)	352 x 240 (25/30 fps)	352 x 240 (25/30 fps)	
				176 x 120 (25/30 fps)	176 x 120 (25/30 fps)	
	176 x 120 (25/30 fps)	176 x 120 (25/30 fps)	800 x 600 (25/30 fps)	800 x 600 (25/30 fps)		
			640 x 480 (25/30 fps)	640 x 480 (25/30 fps)		

H.264 + H.264 + H.264 + MJPEG					
H.264-1	H.264-2	H.264-3	MJPEG		
1024 x 768 (25/30 fps)	1024 x 768 (25/30 fps)	1024 x 768 (25/30 fps)	800 x 600 (25/30 fps)		
			720 x 480 (25/30 fps)		
			640 x 480 (25/30 fps)		
			352 x 240 (25/30 fps)		
			176 x 120 (25/30 fps)		
		800 x 600 (25/30 fps)	800 x 600 (25/30 fps)		
			720 x 480 (25/30 fps)		
			640 x 480 (25/30 fps)		
			352 x 240 (25/30 fps)		
			176 x 120 (25/30 fps)		
		720 x 480 (25/30 fps)	720 x 480 (25/30 fps)		
			640 x 480 (25/30 fps)		
			352 x 240 (25/30 fps)		
			176 x 120 (25/30 fps)		
		640 x 480 (25/30 fps)	640 x 480 (25/30 fps)		
			352 x 240 (25/30 fps)		
			176 x 120 (25/30 fps)		
			352 x 240 (25/30 fps)		
	176 x 120 (25/30 fps)				
	352 x 240 (25/30 fps)	352 x 240 (25/30 fps)			
	176 x 120 (25/30 fps)	176 x 120 (25/30 fps)			
	800 x 600 (25/30 fps)	800 x 600 (25/30 fps)	800 x 600 (25/30 fps)	800 x 600 (25/30 fps)	
				720 x 480 (25/30 fps)	
				640 x 480 (25/30 fps)	
			720 x 480 (25/30 fps)	720 x 480 (25/30 fps)	
				640 x 480 (25/30 fps)	
				352 x 240 (25/30 fps)	
		640 x 480 (25/30 fps)	640 x 480 (25/30 fps)		
			352 x 240 (25/30 fps)		
			176 x 120 (25/30 fps)		
		720 x 480 (25/30 fps)	720 x 480 (25/30 fps)	720 x 480 (25/30 fps)	720 x 480 (25/30 fps)
					640 x 480 (25/30 fps)
					352 x 240 (25/30 fps)
			640 x 480 (25/30 fps)	640 x 480 (25/30 fps)	
				352 x 240 (25/30 fps)	
				176 x 120 (25/30 fps)	
		640 x 480 (25/30 fps)	640 x 480 (25/30 fps)	640 x 480 (25/30 fps)	640 x 480 (25/30 fps)
					352 x 240 (25/30 fps)
					176 x 120 (25/30 fps)
	352 x 240 (25/30 fps)		352 x 240 (25/30 fps)		
			176 x 120 (25/30 fps)		
			176 x 120 (25/30 fps)		
	800 x 600 (25/30 fps)	800 x 600 (25/30 fps)	800 x 600 (25/30 fps)	800 x 600 (25/30 fps)	
				720 x 480 (25/30 fps)	
				720 x 480 (25/30 fps)	

H.264 + H.264 + H.264 + MJPEG				
H.264-1	H.264-2	H.264-3	MJPEG	
			640 x 480 (25/30 fps)	
			352 x 240 (25/30 fps)	
			176 x 120 (25/30 fps)	
		720 x 480 (25/30 fps)		720 x 480 (25/30 fps)
				640 x 480 (25/30 fps)
				352 x 240 (25/30 fps)
		640 x 480 (25/30 fps)		176 x 120 (25/30 fps)
				640 x 480 (25/30 fps)
				352 x 240 (25/30 fps)
		352 x 240 (25/30 fps)		176 x 120 (25/30 fps)
				352 x 240 (25/30 fps)
				176 x 120 (25/30 fps)
	176 x 120 (25/30 fps)		176 x 120 (25/30 fps)	
			720 x 480 (25/30 fps)	
			640 x 480 (25/30 fps)	
	720 x 480 (25/30 fps)	720 x 480 (25/30 fps)	352 x 240 (25/30 fps)	
			176 x 120 (25/30 fps)	
			640 x 480 (25/30 fps)	
	640 x 480 (25/30 fps)	640 x 480 (25/30 fps)	352 x 240 (25/30 fps)	
			176 x 120 (25/30 fps)	
			176 x 120 (25/30 fps)	
	352 x 240 (25/30 fps)	352 x 240 (25/30 fps)	176 x 120 (25/30 fps)	
			176 x 120 (25/30 fps)	
			176 x 120 (25/30 fps)	
176 x 120 (25/30 fps)	176 x 120 (25/30 fps)	176 x 120 (25/30 fps)		
		720 x 480 (25/30 fps)		
		640 x 480 (25/30 fps)		
720 x 480 (25/30 fps)	720 x 480 (25/30 fps)	720 x 480 (25/30 fps)	640 x 480 (25/30 fps)	
			352 x 240 (25/30 fps)	
			176 x 120 (25/30 fps)	
	640 x 480 (25/30 fps)	640 x 480 (25/30 fps)	640 x 480 (25/30 fps)	352 x 240 (25/30 fps)
				176 x 120 (25/30 fps)
				176 x 120 (25/30 fps)
	352 x 240 (25/30 fps)	352 x 240 (25/30 fps)	352 x 240 (25/30 fps)	176 x 120 (25/30 fps)
				176 x 120 (25/30 fps)
				176 x 120 (25/30 fps)
	176 x 120 (25/30 fps)	176 x 120 (25/30 fps)	176 x 120 (25/30 fps)	176 x 120 (25/30 fps)
				640 x 480 (25/30 fps)
				352 x 240 (25/30 fps)
640 x 480 (25/30 fps)	640 x 480 (25/30 fps)	640 x 480 (25/30 fps)	176 x 120 (25/30 fps)	
			176 x 120 (25/30 fps)	
			176 x 120 (25/30 fps)	
352 x 240 (25/30 fps)	352 x 240 (25/30 fps)	352 x 240 (25/30 fps)	176 x 120 (25/30 fps)	
			176 x 120 (25/30 fps)	
			176 x 120 (25/30 fps)	
176 x 120 (25/30 fps)	176 x 120 (25/30 fps)	176 x 120 (25/30 fps)	176 x 120 (25/30 fps)	
			640 x 480 (25/30 fps)	
			352 x 240 (25/30 fps)	

H.264 + H.264 + H.264 + MJPEG			
H.264-1	H.264-2	H.264-3	MJPEG
640 x 480 (25/30 fps)	640 x 480 (25/30 fps)	640 x 480 (25/30 fps)	640 x 480 (25/30 fps)

H.264 + H.264 + H.264 + MJPEG			
H.264-1	H.264-2	H.264-3	MJPEG
			352 x 240 (25/30 fps)
			176 x 120 (25/30 fps)
		352 x 240 (25/30 fps)	352 x 240 (25/30 fps)
			176 x 120 (25/30 fps)
		176 x 120 (25/30 fps)	352 x 240 (25/30 fps)
			176 x 120 (25/30 fps)
352 x 240 (25/30 fps)	352 x 240 (25/30 fps)	352 x 240 (25/30 fps)	
		176 x 120 (25/30 fps)	
	176 x 120 (25/30 fps)	176 x 120 (25/30 fps)	
		176 x 120 (25/30 fps)	
176 x 120 (25/30 fps)	176 x 120 (25/30 fps)	176 x 120 (25/30 fps)	

*BNC is not supported.

1.3M- Triple Streams (25/30 fps)

H.264 + H.264 + H.264		
H.264-1	H.264-2	H.264-3
1280 x 1024 (25/30 fps)	1280 x 720 (25/30 fps)	800 x 600 (25/30 fps)
		720 x 480 (25/30 fps)
		640 x 480 (25/30 fps)
		352 x 240 (25/30 fps)
		176 x 120 (25/30 fps)
	1024 x 768 (25/30 fps)	1024 x 768 (25/30 fps)
		800 x 600 (25/30 fps)
		720 x 480 (25/30 fps)
		640 x 480 (25/30 fps)
		352 x 240 (25/30 fps)
	800 x 600 (25/30 fps)	176 x 120 (25/30 fps)
		800 x 600 (25/30 fps)
		720 x 480 (25/30 fps)
		640 x 480 (25/30 fps)
		352 x 240 (25/30 fps)
	720 x 480 (25/30 fps)	176 x 120 (25/30 fps)
		352 x 240 (25/30 fps)
		640 x 480 (25/30 fps)
640 x 480 (25/30 fps)	176 x 120 (25/30 fps)	
	352 x 240 (25/30 fps)	
352 x 240 (25/30 fps)	176 x 120 (25/30 fps)	
	352 x 240 (25/30 fps)	
176 x 120 (25/30 fps)	176 x 120 (25/30 fps)	
	176 x 120 (25/30 fps)	
1280 x 720 (25/30 fps)	1280 x 720 (25/30 fps)	1280 x 720 (25/30 fps)
		1024 x 768 (25/30 fps)
		800 x 600 (25/30 fps)
		720 x 480 (25/30 fps)
		640 x 480 (25/30 fps)
		352 x 240 (25/30 fps)
	1024 x 768 (25/30 fps)	176 x 120 (25/30 fps)
		1024 x 768 (25/30 fps)
		800 x 600 (25/30 fps)
		720 x 480 (25/30 fps)
		640 x 480 (25/30 fps)
		352 x 240 (25/30 fps)
	800 x 600 (25/30 fps)	176 x 120 (25/30 fps)
		800 x 600 (25/30 fps)
		720 x 480 (25/30 fps)
		640 x 480 (25/30 fps)
	720 x 480 (25/30 fps)	352 x 240 (25/30 fps)
		176 x 120 (25/30 fps)
		720 x 480 (25/30 fps)
	640 x 480 (25/30 fps)	640 x 480 (25/30 fps)
		352 x 240 (25/30 fps)
		176 x 120 (25/30 fps)
	352 x 240 (25/30 fps)	352 x 240 (25/30 fps)
		176 x 120 (25/30 fps)
	176 x 120 (25/30 fps)	176 x 120 (25/30 fps)
		176 x 120 (25/30 fps)

H.264 + H.264 + H.264			
H.264-1	H.264-2	H.264-3	
1024 x 768 (25/30 fps)	1024 x 768 (25/30 fps)	1024 x 768 (25/30 fps)	
		800 x 600 (25/30 fps)	
		720 x 480 (25/30 fps)	
		640 x 480 (25/30 fps)	
		352 x 240 (25/30 fps)	
		176 x 120 (25/30 fps)	
	800 x 600 (25/30 fps)	800 x 600 (25/30 fps)	800 x 600 (25/30 fps)
			720 x 480 (25/30 fps)
			640 x 480 (25/30 fps)
			352 x 240 (25/30 fps)
	720 x 480 (25/30 fps)	720 x 480 (25/30 fps)	176 x 120 (25/30 fps)
			720 x 480 (25/30 fps)
			640 x 480 (25/30 fps)
	640 x 480 (25/30 fps)	640 x 480 (25/30 fps)	352 x 240 (25/30 fps)
176 x 120 (25/30 fps)			
352 x 240 (25/30 fps)	352 x 240 (25/30 fps)	176 x 120 (25/30 fps)	
		176 x 120 (25/30 fps)	
800 x 600 (25/30 fps)	800 x 600 (25/30 fps)	176 x 120 (25/30 fps)	
		800 x 600 (25/30 fps)	
		720 x 480 (25/30 fps)	
		640 x 480 (25/30 fps)	
	720 x 480 (25/30 fps)	720 x 480 (25/30 fps)	352 x 240 (25/30 fps)
			176 x 120 (25/30 fps)
			720 x 480 (25/30 fps)
	640 x 480 (25/30 fps)	640 x 480 (25/30 fps)	640 x 480 (25/30 fps)
			352 x 240 (25/30 fps)
	352 x 240 (25/30 fps)	352 x 240 (25/30 fps)	176 x 120 (25/30 fps)
			176 x 120 (25/30 fps)
	176 x 120 (25/30 fps)	176 x 120 (25/30 fps)	176 x 120 (25/30 fps)
			176 x 120 (25/30 fps)
	720 x 480 (25/30 fps)	720 x 480 (25/30 fps)	176 x 120 (25/30 fps)
720 x 480 (25/30 fps)			
640 x 480 (25/30 fps)			
352 x 240 (25/30 fps)			
640 x 480 (25/30 fps)		640 x 480 (25/30 fps)	176 x 120 (25/30 fps)
			640 x 480 (25/30 fps)
			352 x 240 (25/30 fps)
352 x 240 (25/30 fps)		352 x 240 (25/30 fps)	176 x 120 (25/30 fps)
			176 x 120 (25/30 fps)
176 x 120 (25/30 fps)		176 x 120 (25/30 fps)	176 x 120 (25/30 fps)
	176 x 120 (25/30 fps)		
640 x 480 (25/30 fps)	640 x 480 (25/30 fps)	640 x 480 (25/30 fps)	
		352 x 240 (25/30 fps)	
	352 x 240 (25/30 fps)	352 x 240 (25/30 fps)	176 x 120 (25/30 fps)
			176 x 120 (25/30 fps)
352 x 240 (25/30 fps)	352 x 240 (25/30 fps)	176 x 120 (25/30 fps)	
		176 x 120 (25/30 fps)	

H.264 + H.264 + H.264		
H.264-1	H.264-2	H.264-3
	176 x 120 (25/30 fps)	176 x 120 (25/30 fps)
176 x 120 (25/30 fps)	176 x 120 (25/30 fps)	176 x 120 (25/30 fps)

*BNC is supported.

H.264 + H.264 + MJPEG		
H.264-1	H.264-2	MJPEG
1280 x 1024 (25/30 fps)	1280 x 720 (25/30 fps)	800 x 600 (25/30 fps)
		720 x 480 (25/30 fps)
		640 x 480 (25/30 fps)
		352 x 240 (25/30 fps)
		176 x 120 (25/30 fps)
	1024 x 768 (25/30 fps)	1024 x 768 (25/30 fps)
		800 x 600 (25/30 fps)
		720 x 480 (25/30 fps)
		640 x 480 (25/30 fps)
		352 x 240 (25/30 fps)
		176 x 120 (25/30 fps)
	800 x 600 (25/30 fps)	800 x 600 (25/30 fps)
		720 x 480 (25/30 fps)
		640 x 480 (25/30 fps)
		352 x 240 (25/30 fps)
	720 x 480 (25/30 fps)	720 x 480 (25/30 fps)
		640 x 480 (25/30 fps)
		352 x 240 (25/30 fps)
		176 x 120 (25/30 fps)
	640 x 480 (25/30 fps)	640 x 480 (25/30 fps)
		352 x 240 (25/30 fps)
		176 x 120 (25/30 fps)
	352 x 240 (25/30 fps)	352 x 240 (25/30 fps)
		176 x 120 (25/30 fps)
176 x 120 (25/30 fps)	176 x 120 (25/30 fps)	
1280 x 720 (25/30 fps)	1280 x 720 (25/30 fps)	1280 x 720 (25/30 fps)
		1024 x 768 (25/30 fps)
		800 x 600 (25/30 fps)
		720 x 480 (25/30 fps)
		640 x 480 (25/30 fps)
		352 x 240 (25/30 fps)
	1024 x 768 (25/30 fps)	1024 x 768 (25/30 fps)
		800 x 600 (25/30 fps)
		720 x 480 (25/30 fps)
		640 x 480 (25/30 fps)
		352 x 240 (25/30 fps)
		176 x 120 (25/30 fps)
	800 x 600 (25/30 fps)	800 x 600 (25/30 fps)
		720 x 480 (25/30 fps)
		640 x 480 (25/30 fps)
		352 x 240 (25/30 fps)
	720 x 480 (25/30 fps)	720 x 480 (25/30 fps)
		640 x 480 (25/30 fps)
		352 x 240 (25/30 fps)
		176 x 120 (25/30 fps)

H.264 + H.264 + MJPEG		
H.264-1	H.264-2	MJPEG
	640 x 480 (25/30 fps)	176 x 120 (25/30 fps)
		640 x 480 (25/30 fps)
		352 x 240 (25/30 fps)
		176 x 120 (25/30 fps)
	352 x 240 (25/30 fps)	352 x 240 (25/30 fps)
	176 x 120 (25/30 fps)	176 x 120 (25/30 fps)

H.264 + H.264 + MJPEG			
H.264-1	H.264-2	MJPEG	
1024 x 768 (25/30 fps)	1024 x 768 (25/30 fps)	1024 x 768 (25/30 fps)	
		800 x 600 (25/30 fps)	
		720 x 480 (25/30 fps)	
		640 x 480 (25/30 fps)	
		352 x 240 (25/30 fps)	
		176 x 120 (25/30 fps)	
	800 x 600 (25/30 fps)	800 x 600 (25/30 fps)	800 x 600 (25/30 fps)
			720 x 480 (25/30 fps)
			640 x 480 (25/30 fps)
			352 x 240 (25/30 fps)
			176 x 120 (25/30 fps)
			720 x 480 (25/30 fps)
	720 x 480 (25/30 fps)	720 x 480 (25/30 fps)	720 x 480 (25/30 fps)
			640 x 480 (25/30 fps)
			352 x 240 (25/30 fps)
			176 x 120 (25/30 fps)
			640 x 480 (25/30 fps)
			352 x 240 (25/30 fps)
640 x 480 (25/30 fps)	640 x 480 (25/30 fps)	640 x 480 (25/30 fps)	
		352 x 240 (25/30 fps)	
		176 x 120 (25/30 fps)	
		352 x 240 (25/30 fps)	
		176 x 120 (25/30 fps)	
		176 x 120 (25/30 fps)	
352 x 240 (25/30 fps)	352 x 240 (25/30 fps)	352 x 240 (25/30 fps)	
		176 x 120 (25/30 fps)	
		176 x 120 (25/30 fps)	
		176 x 120 (25/30 fps)	
		176 x 120 (25/30 fps)	
		176 x 120 (25/30 fps)	
176 x 120 (25/30 fps)	176 x 120 (25/30 fps)	176 x 120 (25/30 fps)	
		176 x 120 (25/30 fps)	
		176 x 120 (25/30 fps)	
		176 x 120 (25/30 fps)	
		176 x 120 (25/30 fps)	
		176 x 120 (25/30 fps)	
800 x 600 (25/30 fps)	800 x 600 (25/30 fps)	800 x 600 (25/30 fps)	
		720 x 480 (25/30 fps)	
		640 x 480 (25/30 fps)	
		352 x 240 (25/30 fps)	
	720 x 480 (25/30 fps)	720 x 480 (25/30 fps)	720 x 480 (25/30 fps)
			640 x 480 (25/30 fps)
			352 x 240 (25/30 fps)
			176 x 120 (25/30 fps)
	640 x 480 (25/30 fps)	640 x 480 (25/30 fps)	640 x 480 (25/30 fps)
			352 x 240 (25/30 fps)
			176 x 120 (25/30 fps)
			176 x 120 (25/30 fps)
352 x 240 (25/30 fps)	352 x 240 (25/30 fps)	352 x 240 (25/30 fps)	
		176 x 120 (25/30 fps)	
		176 x 120 (25/30 fps)	
		176 x 120 (25/30 fps)	
720 x 480 (25/30 fps)	720 x 480 (25/30 fps)	720 x 480 (25/30 fps)	
		640 x 480 (25/30 fps)	
		352 x 240 (25/30 fps)	
		176 x 120 (25/30 fps)	
	640 x 480 (25/30 fps)	640 x 480 (25/30 fps)	
	640 x 480 (25/30 fps)	640 x 480 (25/30 fps)	

H.264 + H.264 + MJPEG		
H.264-1	H.264-2	MJPEG
		352 x 240 (25/30 fps)
		176 x 120 (25/30 fps)
	352 x 240 (25/30 fps)	352 x 240 (25/30 fps)
	176 x 120 (25/30 fps)	176 x 120 (25/30 fps)
640 x 480 (25/30 fps)	640 x 480 (25/30 fps)	640 x 480 (25/30 fps)
		352 x 240 (25/30 fps)
	352 x 240 (25/30 fps)	352 x 240 (25/30 fps)
	176 x 120 (25/30 fps)	176 x 120 (25/30 fps)
352 x 240 (25/30 fps)	352 x 240 (25/30 fps)	352 x 240 (25/30 fps)
	176 x 120 (25/30 fps)	176 x 120 (25/30 fps)
	176 x 120 (25/30 fps)	176 x 120 (25/30 fps)
176 x 120 (25/30 fps)	176 x 120 (25/30 fps)	176 x 120 (25/30 fps)

*BNC is supported.

1.3M- Dual Streams (25/30 fps)

H.264 + H.264	
H.264-1	H.264-2
1280 x 1024 (25/30 fps)	1280 x 1024 (25/30 fps)
	1280 x 720 (25/30 fps)
	1024 x 768 (25/30 fps)
	800 x 600 (25/30 fps)
	720 x 480 (25/30 fps)
	640 x 480 (25/30 fps)
	352 x 240 (25/30 fps)
1280 x 720 (25/30 fps)	176 x 120 (25/30 fps)
	1280 x 720 (25/30 fps)
	1024 x 768 (25/30 fps)
	800 x 600 (25/30 fps)
	720 x 480 (25/30 fps)
	640 x 480 (25/30 fps)
	352 x 240 (25/30 fps)
1024 x 768 (25/30 fps)	176 x 120 (25/30 fps)
	1024 x 768 (25/30 fps)
	800 x 600 (25/30 fps)
	720 x 480 (25/30 fps)
	640 x 480 (25/30 fps)
	352 x 240 (25/30 fps)
800 x 600 (25/30 fps)	176 x 120 (25/30 fps)
	800 x 600 (25/30 fps)
	720 x 480 (25/30 fps)
	640 x 480 (25/30 fps)
	352 x 240 (25/30 fps)
720 x 480 (25/30 fps)	176 x 120 (25/30 fps)
	720 x 480 (25/30 fps)
	640 x 480 (25/30 fps)
	352 x 240 (25/30 fps)
640 x 480 (25/30 fps)	176 x 120 (25/30 fps)
	640 x 480 (25/30 fps)
	352 x 240 (25/30 fps)
352 x 240 (25/30 fps)	352 x 240 (25/30 fps)
176 x 120 (25/30 fps)	176 x 120 (25/30 fps)
176 x 120 (25/30 fps)	176 x 120 (25/30 fps)

*BNC is supported.

H.264 + MJPEG	
H.264-1	MJPEG
1280 x 1024 (25/30 fps)	1280 x 1024 (25/30 fps)
	1280 x 720 (25/30 fps)
	1024 x 768 (25/30 fps)
	800 x 600 (25/30 fps)
	720 x 480 (25/30 fps)
	640 x 480 (25/30 fps)
	352 x 240 (25/30 fps)
	176 x 120 (25/30 fps)
1280 x 720 (25/30 fps)	1280 x 720 (25/30 fps)
	1024 x 768 (25/30 fps)
	800 x 600 (25/30 fps)
	720 x 480 (25/30 fps)
	640 x 480 (25/30 fps)
	352 x 240 (25/30 fps)
	176 x 120 (25/30 fps)
1024 x 768 (25/30 fps)	1024 x 768 (25/30 fps)
	800 x 600 (25/30 fps)
	720 x 480 (25/30 fps)
	640 x 480 (25/30 fps)
	352 x 240 (25/30 fps)
800 x 600 (25/30 fps)	176 x 120 (25/30 fps)
	800 x 600 (25/30 fps)
	720 x 480 (25/30 fps)
	640 x 480 (25/30 fps)
	352 x 240 (25/30 fps)
720 x 480 (25/30 fps)	176 x 120 (25/30 fps)
	720 x 480 (25/30 fps)
	640 x 480 (25/30 fps)
	352 x 240 (25/30 fps)
640 x 480 (25/30 fps)	176 x 120 (25/30 fps)
	640 x 480 (25/30 fps)
	352 x 240 (25/30 fps)
352 x 240 (25/30 fps)	176 x 120 (25/30 fps)
	352 x 240 (25/30 fps)
176 x 120 (25/30 fps)	176 x 120 (25/30 fps)

*BNC is supported.

1.3M- Single Stream (25/30 fps)

H.264	
	1280 x 1024 (25/30 fps)
	1280 x 720 (25/30 fps)
	1024 x 768 (25/30 fps)
	800 x 600 (25/30 fps)
	720 x 480 (25/30 fps)
	640 x 480 (25/30 fps)
	352 x 240 (25/30 fps)
	176 x 120 (25/30 fps)

*BNC is supported.

MJPEG	
	1280 x 1024 (25/30 fps)
	1280 x 720 (25/30 fps)
	1024 x 768 (25/30 fps)
	800 x 600 (25/30 fps)
	720 x 480 (25/30 fps)
	640 x 480 (25/30 fps)
	352 x 240 (25/30 fps)
	176 x 120 (25/30 fps)

*BNC is supported.

1.3M- Dual Streams (50/60 fps)

H.264 + H.264	
H.264-1	H.264-2
1280 x 720 (50/60 fps)	800 x 600 (50/60 fps)
	720 x 480 (50/60 fps)
	640 x 480 (50/60 fps)
	352 x 240 (50/60 fps)
	176 x 120 (50/60 fps)
1024 x 768 (50/60 fps)	800 x 600 (50/60 fps)
	720 x 480 (50/60 fps)
	640 x 480 (50/60 fps)
	352 x 240 (50/60 fps)
	176 x 120 (50/60 fps)
800 x 600 (50/60 fps)	800 x 600 (50/60 fps)
	720 x 480 (50/60 fps)
	640 x 480 (50/60 fps)
	352 x 240 (50/60 fps)
	176 x 120 (50/60 fps)
720 x 480 (50/60 fps)	720 x 480 (50/60 fps)
	640 x 480 (50/60 fps)
	352 x 240 (50/60 fps)
	176 x 120 (50/60 fps)
640 x 480 (50/60 fps)	640 x 480 (50/60 fps)
	352 x 240 (50/60 fps)
	176 x 120 (50/60 fps)
352 x 240 (50/60 fps)	352 x 240 (50/60 fps)
176 x 120 (50/60 fps)	176 x 120 (50/60 fps)
176 x 120 (50/60 fps)	176 x 120 (50/60 fps)

*BNC is not supported.

H.264 + MJPEG	
H.264-1	MJPEG
1280 x 720 (50/60 fps)	800 x 600 (50/60 fps)
	720 x 480 (50/60 fps)
	640 x 480 (50/60 fps)
	352 x 240 (50/60 fps)
	176 x 120 (50/60 fps)
1024 x 768 (50/60 fps)	800 x 600 (50/60 fps)
	720 x 480 (50/60 fps)
	640 x 480 (50/60 fps)
	352 x 240 (50/60 fps)
	176 x 120 (50/60 fps)
800 x 600 (50/60 fps)	800 x 600 (50/60 fps)
	720 x 480 (50/60 fps)
	640 x 480 (50/60 fps)
	352 x 240 (50/60 fps)
	176 x 120 (50/60 fps)
720 x 480 (50/60 fps)	720 x 480 (50/60 fps)
	640 x 480 (50/60 fps)
	352 x 240 (50/60 fps)
	176 x 120 (50/60 fps)
640 x 480 (50/60 fps)	640 x 480 (50/60 fps)
	352 x 240 (50/60 fps)
	176 x 120 (50/60 fps)
352 x 240 (50/60 fps)	352 x 240 (50/60 fps)
176 x 120 (50/60 fps)	176 x 120 (50/60 fps)
176 x 120 (50/60 fps)	176 x 120 (50/60 fps)

*BNC is not supported.

1.3M- Single Stream (50/60 fps)

H.264	
	1280 x 720 (50/60 fps)
	1024 x 768 (50/60 fps)
	800 x 600 (50/60 fps)
	720 x 480 (50/60 fps)
	640 x 480 (50/60 fps)
	352 x 240 (50/60 fps)
	176 x 120 (50/60 fps)

*BNC is not supported.

MJPEG	
	1280 x 720 (50/60 fps)
	1024 x 768 (50/60 fps)
	800 x 600 (50/60 fps)
	720 x 480 (50/60 fps)
	640 x 480 (50/60 fps)
	352 x 240 (50/60 fps)
	176 x 120 (50/60 fps)

*BNC is not supported.