

EasyView 7.5

Installation Guide

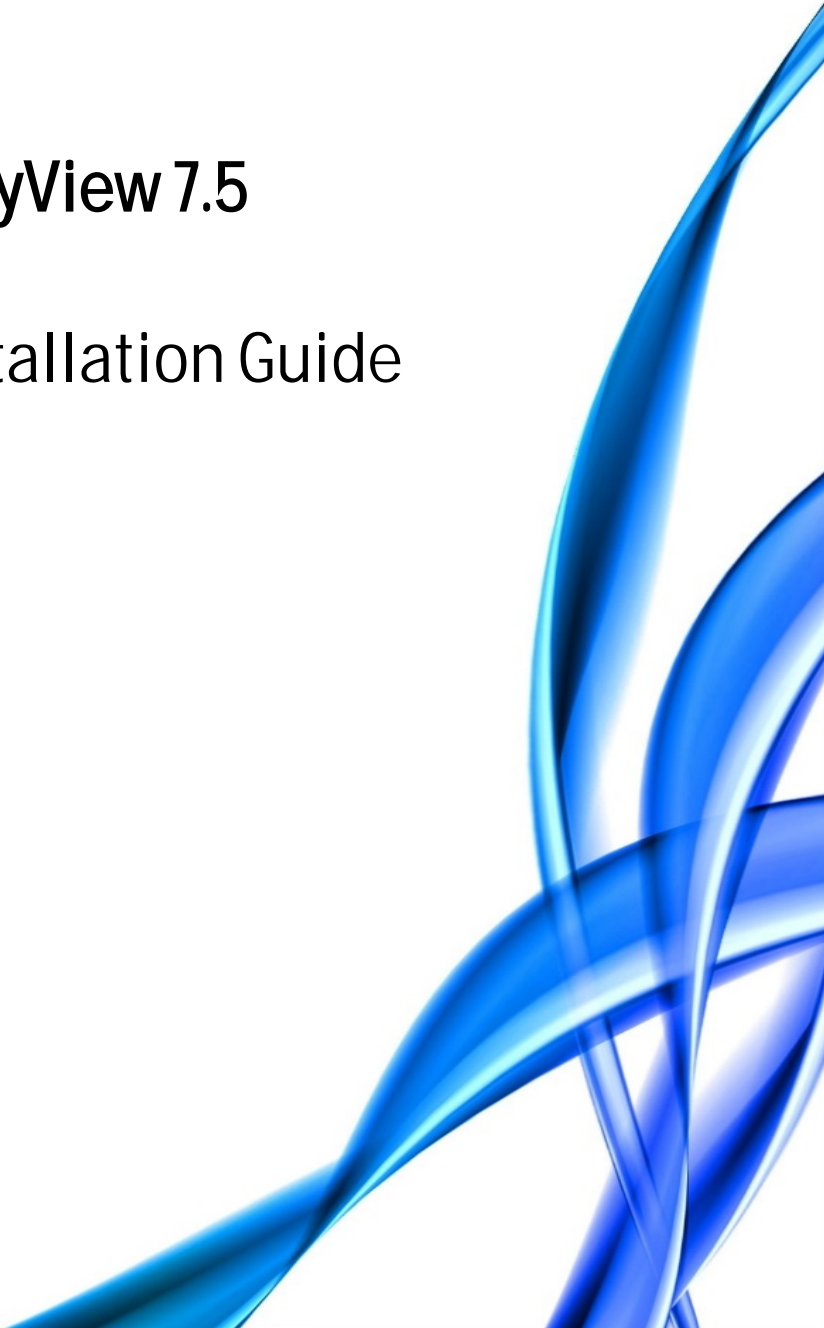

CONTENTS

Default Passwords.....	5
Before You Start.....	6
Help Documentation	6
Manuals For Third Party Devices.....	6
Technical Support	7
What's New	7
About the System.....	8
What is Ernitec Software?	8
Ernitec VMS 7.4 - 32-bit vs. 64-bit Versions 11	
System Requirements.....	15
Minimum Recording Server Requirements.....	15
Minimum Client Workstation Requirements.....	16
OS Compatibility.....	17
Network Requirements.....	18
Recording Server Installation.....	21
Failover Servers - Optional.....	22
Installing Capture Cards.....	23
Installing The Software	27
Installing The .NET Framework.....	27
Installing The Recorder Software.....	27
Set The TCP/IP Addresses.....	30
Set The Master Server's IP Address to The System Files	31
Enable Time Synchronization	31
Obtain a License Key.....	33
Setting Up The System.....	34
Installing Devices	36
Installing IP Cameras	36

Installing PTZ Drivers For IP Cameras.....36

Installing Audio Devices38

Installing Audio Communication39

Installing Analog PTZ Cameras..... 40

Installing External Devices For Analog Domes49

Connecting Digital Inputs And Outputs49

Setting Up DirectX PTZ Joysticks50

Setting Up The Hardware Watchdog50

Installing Client Programs..... 52

 Installing The .NET Framework.....52

 Installing The Client Programs52

 Compatibility.....54

Updating 55

 Updating a Recorder 55

 Updating Client Programs55

 Updating Slave Servers From Master Server.....56

 Updating Components.....56

Flash Memory Backup / Restore 57

 Flash Memory Backup 57

 Flash Memory Restore.....58

Ernitec Gateway Server Installation..... 60

 Minimum System Requirements..... 60

 System Restrictions 60

 Installing The Ernitec Gateway Server..... 61

 Verifying The Installation..... 61

 Streaming Options 61

Installing EasyView Plugins..... 62

Installing VCA Components 63

 Database Installation.....64

Adding License Keys 64
Camera Configuration.....65
VCA Installation.....65
Supported Capture Cards For Analog VCA.....65

DEFAULT PASSWORDS

Microsoft® Windows®

Username: Autologin

Password: N/A

System Manager, Workstation, and System Monitor

Username: Admin

Password: 0308

The default username and password should not be used even in closed networks. Please ensure that the default username and password are not in use after the system has been installed.

BEFORE YOU START

Ernitec VMS software is a distributed Video Management System for video and audio surveillance applications.

The software can be used for monitoring real-time and recorded video, audio and text data, and to control dome cameras, I/O devices and IP cameras.

The software supports systems consisting of both analog and/or digital surveillance cameras, supporting the creation of analog (DVR), digital (NVR) or hybrid (consisting of both analog and digital) surveillance systems.

This guide gives instructions for setting up the recorders and for installing audio devices, IP cameras, dome cameras, video matrices, digital inputs and outputs, and client programs (EasyView, System Manager and Workstation).

HELP DOCUMENTATION

This help documentation, for example, is available:

- *Installation Guide*: Shows how to install the recorders, dome cameras and video matrices, and how to connect digital inputs and outputs.
- *Administrator Guide*: Shows how to use the System Manager program for configuring the system.
- *EasyView User Guide*: Complete instruction how to operate all features of Ernitec EasyView program. (Not available in all languages.)
- *VCA Installation and Configuration Guide*: Instructions how to install and configure Ernitec Video Content Analytics.

The PDF help documentation is on the VMS installation medium and the full setup package that can be downloaded from the Ernitec Extranet.

You can also access the *Administrator's Guide* and the *User's Guide* by clicking **Help** in the System Manager or EasyView programs.

MANUALS FOR THIRD PARTY DEVICES

When installing third party devices (audio devices, IP cameras, dome cameras, and video matrices), follow the manufacturer's instructions.

TECHNICAL SUPPORT

For technical support and warranty issues, please contact the system supplier.

WHAT'S NEW

The lists below include only select information. For a full list of new features and changes, please refer to the Release Notes (*readme.txt* file) included in the installation packages.

NOTE: Since Ernitec VMS Version 7.3.1 Microsoft SQL Server Express 2014 or the full Microsoft SQL Server is required to be installed on the Master Server (in single server installations the only server is the Master Server) and on slave recording servers (nodes) when VCA (Video Content Analytics) is to be utilized.

New features in version 7.5

- Installer installs also SQL Express to 64-bit windows machines
- EasyView user role can be exported and imported

The following new features are documented in the EasyView User Guide

- Storyboard
- Custom camera grids
- Profile Maps can react to alarms by switching view
- Tab plugins can exist in camera grid cell
- Layouts can be loaded from user lock or login
- Camera grid zero bezel border
- Fast bookmarking

ABOUT THE SYSTEM

What Is EasyView Software?

Ernitec software is a distributed, digital video management system (DVMS or EASYVIEW) for video and audio surveillance applications.

The software can be used for monitoring real-time and recorded video, audio and text data, and to control dome (PTZ) cameras, I/O devices and IP cameras.

The software supports systems consisting of both analog and/or digital surveillance cameras, supporting the creation of analog (DVR), digital (NVR) or hybrid (consisting of both analog and digital) surveillance systems.

A centralized surveillance system can consist of up to 100 local or remote recorders.

Ernitec software is sold both separately and as part of Ernitec video management systems consisting of both the software and the recorder hardware. Please contact your Ernitec supplier for information on Ernitec software or hardware.

WHAT DOES A SYSTEM CONTAIN?

The Ernitec system consists of these components:

1-150 Recording Servers

- **Master Recorder** (one of the recorders, or the only recorder in a single-server environment)
- **Slave Recorders** (“nodes,” if the system consists of multiple recorders)

Client programs:

- Ernitec VMS System Manager
- Ernitec VMS EasyView for Windows
- Ernitec VMS EasyView Mobile
- Ernitec VMS WebClient
- Ernitec VMS System Monitor
- Ernitec VMS Workstation (optional)

RECORDING SERVERS

The DVRs and NVRs record video and audio from multiple cameras and audio channels and write the data on hard disks. You can access a recorder locally or over a network by using the System Manager and Workstation programs, and monitor recorder functionality through the System Monitor application.

A recorder contains the computer, the operating system, the recorder software, video capture cards (only DVRs), their drivers, and cameras.

An NVR does not have video capture cards. Instead, it records video from IP cameras connected to a network.

In addition, you can connect these devices to a recorder:

- PTZ/Dome cameras
- PTZ/Dome camera keyboard
- External devices, such as sensors, to the digital inputs of a DVR
- External devices, such as doors, lights, and gates, to the digital outputs of a DVR
- Video monitors (only DVRs)
- Printer
- Backup unit (NAS, SAN, or RAID, for example)

MASTER RECORDER

In a networked, Enterprise system one of the servers must be set as the Master Server. A Master Server is the central recorder of a surveillance system. All other recorders connect to it, and all client applications communicate through the Master Server.

If the system contains only one recorder, that recorder is the Master Server. If there is more than one recorder, the Master Server can be set freely. In a larger system it is recommended that the Master Server is a dedicated server for this purpose alone.

NOTE: *From release 7.3 onwards, all Master Servers must have SQL Server Express or other Microsoft SQL Server installed.*

The Master Recorder does these things:

It verifies the identity of all programs and users who try to log on to the system (authentication).

- It stores all system configuration data.
- It stores all user data.
- It monitors the system.
- It synchronizes the clocks on all recorders.
- It generates reports.
- It stores watchdog event
- It stores alarms
- It stores audit trail

CLIENT PROGRAMS

System administrators use the **System Manager** program for these tasks:

- Configuring the recorders.
- Adding user accounts and user profiles.
- Monitoring the system.

End users use the **EasyView** program, for example, for these tasks:

- Monitor real-time and recorded video and audio
- Control I/O switches and PTZ cameras
- Export video and audio clips to local media
- Receive and handle alarm notifications
- Create video matrixes via the optional, separately sold Agile Video Matrix (AVM) software
- Control automatic license plate recognition systems via the optional, separately sold ANPR+ software

The **Workstation** client is the legacy client that is no longer installed by default. Users can install **Workstation** client by choosing it separately from the installer option menu.

In addition, system administrators can use the **System Monitor** application to monitor the status of the recorders.

This figure shows a system with four recorders (three slave and one master), as well as a connected client computer with four client applications:

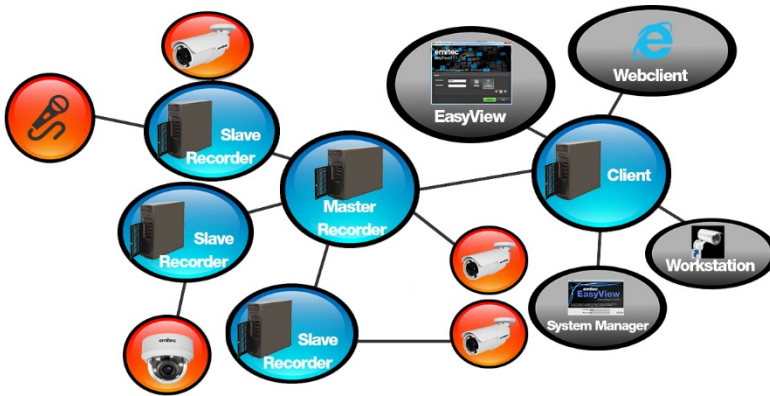

ERNITEC VMS 7.4 - 32-BIT VS. 64-BIT VERSIONS

Starting from Version 7.4 onwards, the Ernitec VMS software is available both as 32-bit (“x86”) and 64-bit (“x64”) versions.

	Windows operating system 32-bit	Windows operating system 64-bit	Drivers, capture cards
<p>CURRENT DEFAULT RECOMMENDATION</p> <p>Ernitec 32-bit</p>	<p>Master server: Ernitec 32-bit</p> <p>Slave: Ernitec 32-bit</p> <p>Client: Ernitec 32-bit</p> <p>Gateway: Ernitec 32-bit</p>	<p>Master server: Ernitec 32-bit</p> <p>Slave: Ernitec 32-bit</p> <p>Client: Ernitec 32-bit</p> <p>Gateway: Ernitec Gateway 32-bit</p>	<p>32-bit camera drivers, Ernitec capture cards can be used</p>

	Ernitec Gateway 32-bit		
Ernitec 64-bit		Master server: Ernitec 64-bit Slave: Ernitec 64-bit Client: Ernitec 64-bit Gateway: Ernitec Gateway 64-bit	64-bit camera drivers Ernitec capture cards cannot be used

USE THE 32-BIT VERSION BY DEFAULT

By default, for all purposes, use the 32-bit (x86) version of Ernitec VMS (even on 64-bit versions of the operating system).

In particular:

- 1) **If you need an analog video capture/compression card, use the 32-bit version** as capture cards are not supported with the 64-bit version of Ernitec VMS.
- 2) **With the v2.* Ernitec ANPR+ and Reporting applications, use the 32-bit version.**
- 3) Note also that **mixed 32-bit and 64-bit systems need more care and expertise for the installation, upgrading and management of the system.** If you are not prepared to handle that, use the 32-bit version of Ernitec VMS.

USE THE 64-BIT VERSION WHEN 3GB OF RAM IS NOT ENOUGH

Use the 64-bit (x64) version of Ernitec VMS only when you know that 3GB of RAM for the recording server process (DVRServer) or for the client application (EasyView) is not enough (either on the recording server, or on the client PC).

For example, if there are so many connected cameras, that processing of all data requires more than 3 GB of RAM (Random Access Memory, run-time memory, main memory).

Note that this refers to per process use of RAM, not the total amount of RAM installed on the machine, or the amount of disk storage.

Other than the stated RAM management, 64-bit EASYVIEW version does not offer any other performance benefits compared to 32-bit version.

MANAGING AN ENVIRONMENT WITH 64-BIT VERSIONS OF ERNITEC VMS

In a networked, multi-server Ernitec VMS Enterprise system, the server with the Master Server role can simultaneously connect to and manage both 32-bit and 64-bit slave recording servers (also sometimes known as “nodes”) on the network:

- A 32-bit Master Server supports simultaneously both 32-bit as well as 64-bit slave recording servers.
- A 64-bit Master Server supports simultaneously both 32-bit as well as 64-bit slave recording servers.
- A Version 7.* based Master Server supports simultaneously both Version 7.* and Version 6.* slave recording servers, but does not support servers based on Version 5.*, or earlier.

The Gateway server, if used, must with a 64-bit Master server also be a 64-bit version.

With a 64-bit Master Server, clients must also be 64-bit versions

When upgrading a Master Server (or a standalone, non-networked server) to the 64-bit version, then you need to also uninstall and reinstall the client applications in order to use the 64-bit version of the client applications (EasyView, System Manager or Workstation):

- With a 64-bit Master Server, the client applications and the Gateway server must also be 64-bit versions, and

- With a 32-bit Master Server, the client applications and the Gateway server must also be 32-bit.

Server upgrading considerations

When using the System Manager application's "Update recorders" -feature to update the slave recording servers in the system, all or the selected recording servers you choose to update will update to the version you choose (which installation file you provide).

In a mixed environment with both 32-bit and 64-bit servers, be careful that you know which servers are to be upgraded to which version, 32-bit or 64-bit!

The 64-bit versions will not work at all on, so called, hybrid servers with internal analog video capture cards (also known as compression cards or grabber cards).

All new IP camera, encoder (video server) or other drivers will be also available as separate 32-bit and 64-bit versions. When installing a new driver or updating an existing driver, you must use a 32-bit driver package on a 32-bit server, and a 64-bit driver package on a 64-bit server.

Note also that since V7.3 all servers with the Master Server role, as well as all slave recording servers with VCA (Video Content Analytics) require Microsoft SQL Server Express to be installed on the server before installing Ernitec VMS.

How to determine whether the installation file is 32-bit or 64-bit?

The 32-bit installation executables have "x86" as part of their name. E.g., for Ernitec VMS V7.5:

"Release_75_EASYVIEW_PAL_**x86**_Full_installer

.exe", and 64-bit executables have "x64":

"Release_75_EASYVIEW_PAL_**x64**_Full_installer.exe".

The origin of this naming convention comes from the naming conventions of Intel 32-bit vs. 64-bit microprocessors (CPUs).

SYSTEM REQUIREMENTS

The Ernitec VMS (Video Management System) software is flexible and scalable network video recording software that consists of Ernitec server software and client application software. The server and client software can be installed on any standard PC platform that fulfills the hardware and operating system (OS) requirements. Servers may also be virtualized using, e.g., Microsoft Hyper-V or VMWare.

Ernitec VMS is delivered either in **pre-assembled servers**, or as **software-only**, in which case the distributor/reseller, an integrator/installer or the end-customer installs the software on a PC.

The performance of a Ernitec VMS solution depends on several factors such as processor type and speed, available memory, and network bandwidth. The requirements below define minimum requirements for running Ernitec VMS software with IP surveillance cameras.

The examples presented in this document should only be used as a base guideline when planning to set up a system. For detailed calculation of system performance and storage capacity requirements, please refer to your Ernitec sales contact or an authorized distributor/reseller.

Please note also that the performance and functionality of a VMS system's server or client software is guaranteed only when it runs as the sole application on the PC platform. No other software applications – with the exception of dedicated server software such as Ernitec ANPR+ (Automatic Number Plate Recognition), Ernitec Reporting, Ernitec VCA (Video Content Analytics), or Microsoft SQL Server when required – should be installed on the computer on which the Ernitec VMS server or client applications are executed. It is also recommended that server and client software should be used on separate computers.

MINIMUM RECORDING SERVER REQUIREMENTS

The recorders require this minimum (small) system configuration:

Hardware:

- Intel Core i3, or better
- 4 GB of RAM (8 GB recommended)
- Min. 1 TB HDD.

In a basic configuration, one hard disk may be enough, but for secure multi-disk recording (modified RAID 0), at least two disk units are required (see the *Ernitec VMS Network Storage Guide* for further information). A separate disk for the operating system and application software is also recommended.

Use of 24/7 optimized HDDs is highly recommended.

NOTE: The VMS software reserves by default 90% of available disk space on other drives than the C-drive for storage use. It does not use the C-drive for storage, except when it is the only drive.

Display adapter with at least 128 MB memory (a dual-head display adapter is optional). Please note that display adapter performance can vary greatly depending on the adapter and the bus architecture used to connect the adapter to the motherboard.

Two 1 Gbps (separate network connections for the camera network and the system network, see the *Ernitec VMS Networking White Paper* for further information).

MINIMUM CLIENT WORKSTATION REQUIREMENTS

These are the minimum requirements for Ernitec VMS Enterprise and Ernitec VMS Pro client applications (such as EasyView for Windows or the System Manager).

The following hardware specification should be viewed only as the minimum requirements for a small scale surveillance system.

- Intel Core i3, or better (when using H.264 cameras in the system, quad-core processors are recommended).

The recommended processor allows simultaneous viewing of more than 10 cameras at a higher resolution than VGA (640×480).

- Min. 4 GB RAM (8 GB recommended)
- Min. 20 GB of free disk space
- Display adapter with at least 512 MB memory. Video adapter memory amount and performance will impact capacity to display simultaneous recorded or live camera streams. (Please note that display adapter performance can vary greatly depending on the adapter and the bus architecture used to connect the adapter to the motherboard.)

OS COMPATIBILITY

Ernitec VMS 7.5 supports the following operating systems:

Operating System	Server with analog camera support via capture cards	Server with only IP cameras or connected video servers (encoders)	Gateway server	System Manager client application	EasyView for Windows client application
Windows 7 Pro / Enterprise	32-bit only	X	X	X	X
Windows 8 Pro & Pro Retail	32-bit only	X	X	X	X
Windows 2008 Server R2 Enterprise	32-bit only	X	X	X	-
Windows 2008 Server R2 Foundation	-	X	X	X	-
Windows 2012 Server Standard Edition	-	X	X	X	-
Windows 2012 Server R2	-	X	X	X	X
Windows 10	-	X	X	X	X

NOTES:

- *Ernitec VMS has not supported Windows XP since Ernitec VMS version 6.4. If Windows XP support is required, do not install Ernitec VMS 6.4, or any later releases.*
- *Make sure that the “Desktop Experience” feature is activated for Windows server operating systems.*

- *No releases before Ernitec VMS V7.4 has support for Windows 10. Any older versions (V7.3 or older), if used with Windows 10, must be upgraded to the latest V7.4 release (V7.4.5 is the latest/current release at the date of this document) or V7.5.*

NETWORK REQUIREMENTS

These network requirements apply to systems where users access the recorders over a network.

Please see the *Ernitec Networking White Paper* and the *Ernitec Network Storage White Paper* for information on networking recommendations, limitations and rules.

GENERAL

A 1 Gbps Ethernet is required on both the client and the server side (see *Bandwidth Requirements*).

Data can be transmitted over the Internet, intranet, LAN, WAN, WLAN, ISDN, ADSL, or any other network using TCP/IP.

For best performance, the camera network should be closed to other network traffic and kept separate from the system network used for server-server or server-client communication.

It is heavily recommended to have at least two 1 Gbps network adapters for each server: at least one adapter for the camera feeds and one adapter for server-client and server-server communications.

In the case of large systems with multiple high resolution and high frame rate cameras, separating specific camera sets into their own networks (and adding network adapters to servers) can be recommended. However, this done case-by-case, and requires case specific calculations on network load.

PTZ (Pan-Tilt-Zoom) control requires a low latency in the network to make dome control as responsive as possible.

NETWORK CARD SETTINGS

Network card setting requirements:

- Interrupt Moderation Rate --> Extreme
- Receive Buffers/Receive Descriptors --> 2048
- Transmit Buffers/Transmit Descriptors --> 2048

IP ADDRESSES

The recorders must have static IP addresses, so that the client programs can connect to them. The Agile Virtual Matrix (AVM) Display Servers should also have either static addresses or names, as the connection from AVM operator console to the display servers is done either with IP address or computer name.

You can use some NAT solutions with the system but not all:

- Static network address translation (NAT) can be used between the recorders and the client programs.
- Dynamic NAT cannot be used because the IP addresses can change.
- Single-address NAT works if there is only one recorder in the NAT system. It does not work if there is more than one recorder in the same system.

PORTS

These ports must be open on the recorders:

- 5008 (TCP), between SMServer (System Manager service) and client programs. Port rule: open inbound
- 5009 (TCP), between DVR Server and client programs. Port rule: open inbound
- 5010 (TCP), between Watchdog Service and client programs. Port rule: open inbound
- 5011 (TCP), between Streaming Service and client programs. Port rule: open inbound

NOTE: *If you are using Windows Firewall, the VMS installer can automatically create exceptions for the required ports. Please see **Installing The Recorder Software** for further information.*

BANDWIDTH REQUIREMENTS

The bandwidth requirements for the network between the recorders and client programs depend on a number of factors. Here are a few aspects to think about:

- Data transmission from the recorders to the client computers (uplink) requires more bandwidth than data transmission from the client computers to the recorder (downlink). The connection does not have to be symmetric.

- Real-time monitoring requires more bandwidth than transmitting recorded video or audio.
- In addition, signaling and protocols increase the required bandwidth.

DATA SECURITY

The system uses a data protection mechanism and user authentication. However, using public networks always includes a security risk because there are no completely secure systems available on the Internet.

For this reason, dedicated networks should be used whenever possible to prevent unauthorized access to the system. Consider using a Virtual Private Network (VPN) to create a secure connection between computers on a public network.

Antivirus programs should also be used if the system units are on a public network (internet, intranet).

RECORDING SERVER INSTALLATION

This chapter shows how to install the video capture cards and the video recording software on a computer that has no previous Ernitec VMS software.

To set up a pre-installed recording server:

- Connect the display, mouse, and keyboard to the computer.
- Connect the network cable to the computer (for network use).
- Connect cameras to the BNC connectors.
- Connect all power cords and turn on the power.
- The recorder starts automatically and begins to record images from the connected cameras with the default settings.

To set up a recording server:

- If your recorder has analog cameras, install the capture card(s) for the cameras, please see the chapter *Installing Capture Cards* for information on installing capture cards.
- Install the recorder software. Please see the chapter *Installing The Software* for information on installing the required software.
- Install cameras and other devices. Please see chapter *Installing Devices* for further information.
- Install the client applications. Please see chapter *Installing Client Programs* for further information.
- If your system will utilize WebClient or EasyView Mobile users, you will need to install the Ernitec Gateway server. For further information, please see chapter *Ernitec Gateway Server Installation*.
- For advanced users only: if your system contains VCA components, install and configure the required software.

To update recording software and client applications:

Please see the chapter *Updating* for information on updating recorder or client software.

FAILOVER SERVERS - OPTIONAL

Ernitec VMS 7.0 and later releases support failover servers. Failover servers are servers that are on a passive standby until the system recognizes that one of the active servers (master or slave) has broken down; at this point a failover server takes the place of the broken server. The broken server can be repaired and replaced as a new failover server, while the failover server that took its place can continue operating as an active server.

For details, see the *Ernitec VMS Administrator Guide*.

Note: *When a failover server is takes the place of an active server, any EasyView plugins (such as ANPR+ or Map Plugins) are not included in the switch and must be re-installed manually after a server restore.*

INSTALLING CAPTURE CARDS

These capture cards and capture card drivers may be used on Ernitec-provided VMS servers:

Capture Card	Channels	Max. ips (PAL, GIF)	Driver Files
MiraCap0405	4	25	MiraSV.inf, MiraSV.sys
MiraCap1606LP	16	100	MiraSV.inf, MiraSV.sys
MiraCap3206	32	180	ecpsvd.inf, ECPSVD.sys
MiraCap3225	32	800	ecpsvc.inf, ECPSVC.sys
MiraCapO1625	16	400	ecpsv.inf, ECPSV.sys
MiraCapO1625D	16	400*	ecpsvu.inf, ECPSVU.sys
MiraCapOC0825H	8	200**	HPSV.inf, HPSV.sys

* = at 4CIF resolution

** = at 4CIF resolution in H.264 format

The .inf files that are used by MiraCap capture cards start the installation. The .sys file must be present in the same folder.

MIRACAP0405LP, MIRACAP1606LP, MIRACAP01625, MIRACAP1625D, AND MIRACAPOC0825H

To install the capture card:

- Put the capture card to a PCI bus.
- Connect the video cable connectors to the connectors on the capture card.
- Connect the cameras to the BNC connectors on the video cables.

To install the capture card driver:

- Start the computer.

- In **Found New Hardware wizard**, select **No, not this time** and click **Next**.
- Select **Install from a list or specific location** and click **Next**.
- Select **Search for the best driver in these locations** and **Include this location in the search**. Click **Browse** and, on the VMS Installation medium, open the folder Drivers and then select the folder with the same name as the capture card.
- Click **Next**. If a dialog box about Windows Logo testing is shown, click **Continue Anyway**. Windows installs the driver.
- Click **Finish**.

***NOTE:** The MiraCap1606 card has four video components and four audio components. MiraCapOC0825 has one video component and one component for compression. Repeat the driver installation until you have installed the driver for all components. MiraCap3206 and MiraCapO1612 have only one component each.*

To make sure that the capture card is correctly installed:

- Click **Start**, point to **Settings**, click **Control Panel**, and then double-click **System**.

On the **Hardware** tab, click **Device Manager**.

Make sure that capture card devices do not show up as having problems.

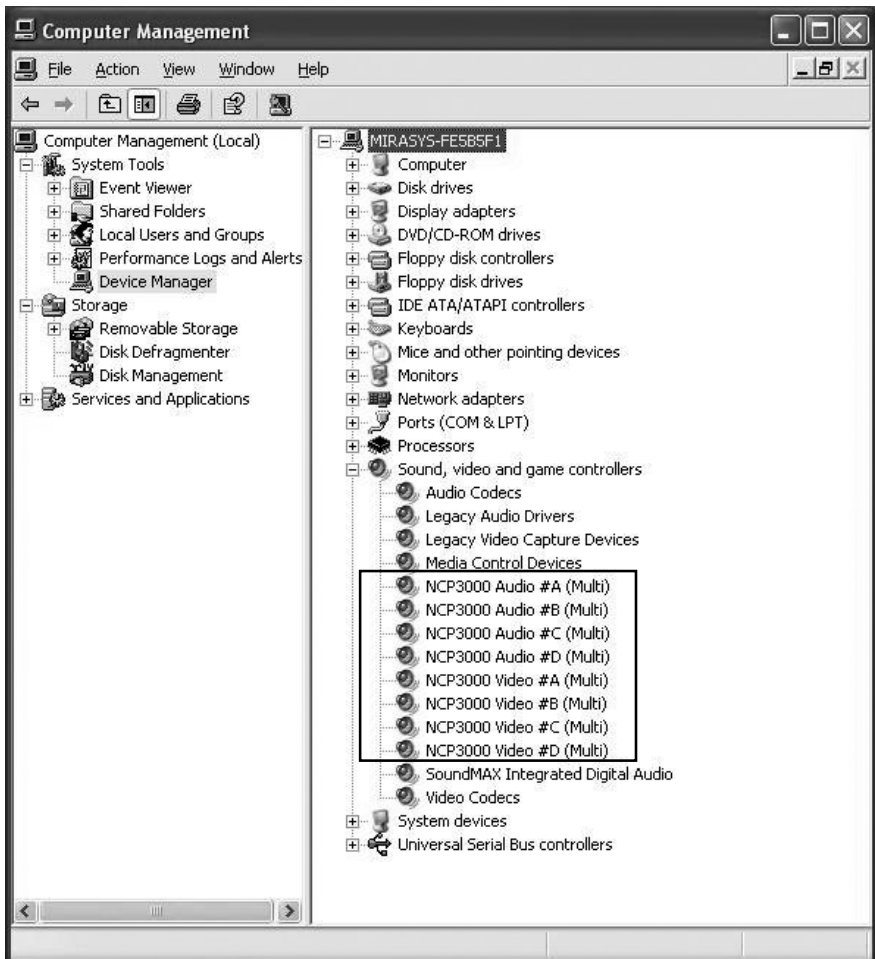

A correctly installed MiraCap1606 capture card.

PICOLO TYMO

To install the capture card:

- Install the capture card in the correct bus.

- Connect the video cable connector to the D-15 connector on the capture card.
- Connect the cameras to the BNC connectors.

To install the MultiCam capture card driver:

- Start the computer. The **Found New Hardware wizard** is shown.
- Click **Cancel**.
- On the VMS Installation medium, in the folder Drivers\Euresys\, double-click the file Multicam_X_X.exe and follow the instructions on the screen.

NOTE: In the Setup Type dialog box, select **Typical**.

To make sure that the capture card is correctly installed:

- Click **Start**, point to **Settings**, click **Control Panel** and then double-click **System**.
- On the **Hardware** tab, click **Device Manager**.
- Make sure that the card is shown as in the following figure.

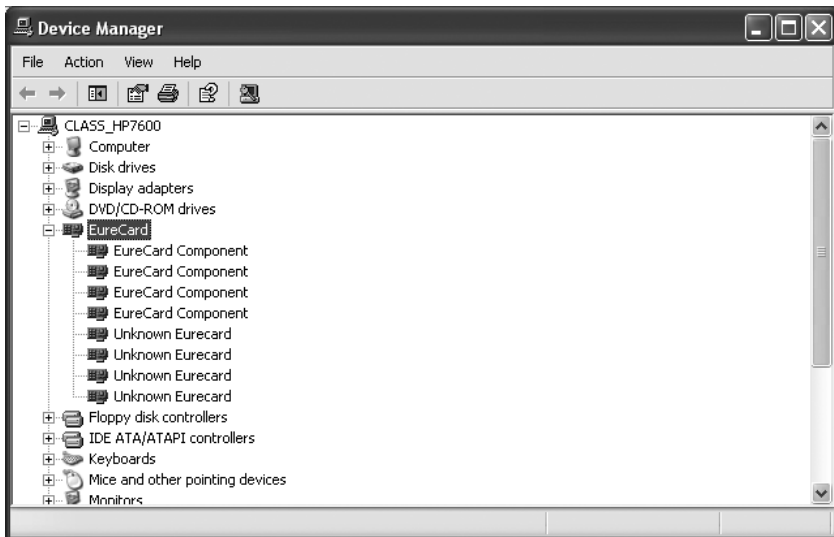

A correctly installed PicoLo Tymo capture card.

INSTALLING THE SOFTWARE

INSTALLING THE .NET FRAMEWORK

Install .NET Framework, and all critical updates on the computer.

To install .NET Framework:

- Click **Start** and then click **Windows Update**.

Install these components (you cannot install all at one time):

- .NET Framework 3.5, 4.0 & 4.5
- Security updates and critical updates

Start **Windows Update** again until you have installed all the necessary components.

INSTALLING THE RECORDER SOFTWARE

During recorder software installation, the installer designates the material disks used to store the recorded data. Effectually, the recorder installer designs the **largest available HDD** as a material disk, as well as **any other HDD** that approximately matches the largest available HDD in size.

After designating the material disks, the installer defines available space on the smallest designated HDD, appropriates all except 10 GB of it for data storage, and appropriates the same amount of space from the other disks. For example, if a recorder has one 1 TB HDD and one 2 TB HDD, the installer appropriates 990 GB of disk space from both disks. In this example, it would be recommendable to split the 2 TB HDD into two 1 TB logical disks, effectually providing the recorder with three 1 TB disks, each with 990 GB worth of designated data storage.

It is highly recommended not to use USB HDDs in the recorder, as they will be used as data storage disks in addition to other HDDs. If, however, you need to have USB HDDs connected to the recorder, it is highly suggested that you disconnect them before installing Ernitec VMS recorder software. You can attach them after installing the software, and they will not be used as material disks unless specifically designated through System Manager. (The same applies to other HDDs added after recorder installation.)

If you do not disconnect the USB HDDs before software installation, the recorder software will automatically use them to store recorder media files.

NOTE: *These instructions apply only when installing software to a new recorder or re-installing software to a recorder not provided by Ernitec. When re-installing software to a recorder provided by Ernitec after e.g. a hard disk failure, please see **Flash Memory Backup / Restore** for further information.*

IMPORTANT NOTE: *VMS 7.3 version or later will require SQL Express to be installed on the Master server. Also other Microsoft SQL server works, but then the configuration has to be customized. Ernitec shall provide installer which will install the SQL Express with correct settings as part of the VMS install. If you are planning to use for example Microsoft SQL Server Enterprise, contact Ernitec support on how to configure the SQL connection string to get the database connection working correctly.*

IMPORTANT NOTE: *VMS 7.5.x version or later is available as Full installer and Limited installer.*

The Limited installer can be used with

- *Client application installs*
- *Slave Recording Server installs or upgrades when no VCA is required*
- *Upgrade installs when SQL is already installed*

The Full installer should be used with

- *Master Server installs*
- *Slave Recording Server installs when VCA is required*

To install the recorder software:

- Copy the installer package somewhere on the machine where you want to do the install.
- Start the VMS installer by double clicking the installer file
Release_7XX_EASYVIEW_XXX_Full_installer.exe /
Release_7XX_EASYVIEW_XXX_Limited_installer.exe

NOTE: *The Ernitec VMS 7.X software is not compatible with Ernitec VMS 6.X or earlier licenses. If you are upgrading from Ernitec VMS 6.X or earlier, it is important to update the license key before continuing to install the software. If the software is upgraded before the license key is*

updated, all recorder specific information (including profiles and stored material) will be lost. Please see

- **Obtain a License** Key for information on updating the licensekey.
- In Welcome to the VMS Installation, click **Install**.
- If you are installing a new system with the Full installer and the installer detects that the system needs MS SQL server, installation of MS SQL Express 2014 will start. This takes approximately 7-8 minutes. If installer detects already a SQL installation on the PC, this step is skipped automatically
- Installer next installs SlimDX to the system. This takes approximately 30 seconds
- After this, the “Welcome to VMS Setup Wizard” is displayed. Click **Next**.
- In the next screen, you can select various installation options
- If you install Recorder, you will need a VMS license. If you only install client applications, you will not need a VMS license.
- By default, the setup program installs the recorder and the applications System Manager, EasyView, and System Monitor:

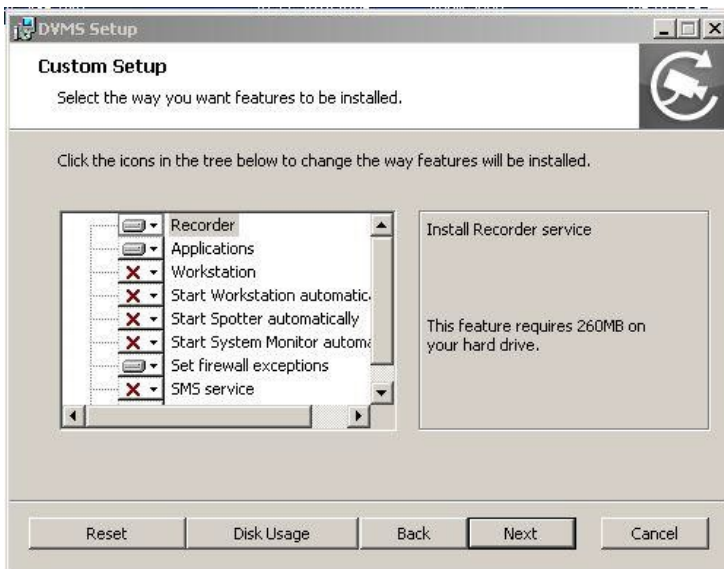

If you do not want to install the applications on the recorder, open the menu next to **Applications** and select **Entire feature will be unavailable**.

If you want the Workstation application, choose it from the list. You can also define if Workstation, EasyView or System Monitor should start automatically

If you want firewall exceptions set automatically for Windows Firewall, open the menu next to **Set firewall exceptions** and select **Will be installed on local hard drive**. Do not select this option if you are not using Windows Firewall.

Click **Next**.

Select the destination folder and click **Next**.

In the Installation Configuration dialog box, specify the IP address or DNS name of the Master Recorder. The Master Recorder is the recorder where all system configuration data is stored when more than one recorder is used in the same system. (This dialog box is not shown if only the recorder is installed). If the Master Recorder is the local computer, use the default value 127.0.0.1. Then click **Next**.

Select the video standard and click **Next**. Then click **Install** to start the installation.

When the recorder has been installed, the dialog box “Completed the VMS Setup Wizard” is shown.

Click **Finish**.

For information about setting up the recorder, see *Recording Server Installation*.

For information about how to install the client programs, see *Installing Client Programs*.

SET THE TCP/IP ADDRESSES

To set the TCP/IP addresses in Windows 7:

- Click **Start**, point to **Settings** and then click **Control Panel**.
- Double-click **Network and Internet**.
- Double-click **Network and Sharing Center**.

- Click “**Change adapter settings**”
- Right-click on the network adapter of your choice and choose **Properties**.
- Click **Internet Protocol v4 (TCP/IP)** and then click **Properties**.
- Select **Use the following IP address** and type a static IP address. Also specify the **Subnet Mask, Default Gateway and DNS Server address**.

SET THE MASTER SERVER’S IP ADDRESS TO THE SYSTEM FILES

If the recorder will function as the Master Server (Master Recorder) of a system, and if it will be accessed over a network, you have to set the recorder’s IP address through the System Manager application.

To set the IP address through System Manager:

- Start System Manager locally on the Master Server as instructed in the *Administrator Guide*.

In the **System** tab, click **Change recorder addresses**.

Click on **Local Recorder**.

Click the **Change recorder address** button .

Type the new IP address or DNS name of the recorder into the **New recorder address** field.

Click **OK**.

NOTE: *You only need to set the local IP address for the Master Server of a system if the recorder can be accessed over a network. If the recorder is accessed locally, there is no need to set the address.*

ENABLE TIME SYNCHRONIZATION

When more than one recorder is used in the same system, the Master Recorder keeps the clocks of all Slave Recorders synchronized. For this reason, one recorder should not belong to more than one system.

The Master Server synchronizes the clocks once a day. However, if the time difference between the clock on the Master Server and the clock on the other recorder is more than 29 minutes, the clocks are not synchronized.

For the time synchronization to work correctly, the Windows time synchronization must be disabled on the other recorders. However, it can be enabled on the Master Server.

To disable Windows time synchronization:

- Click **Start**, point to **Settings**, click **Control Panel**, and then double-click **Date and Time**.
- On the **Internet Time** tab, make sure that the check-box **Automatically synchronize with an Internet time server** is not selected.

OBTAIN A LICENSE KEY



By default, without a VMS license, the recorder supports only one IP camera. To get the full functionality, get a license key from Ernitec. For the license key, you need the MAC address of the recorder.

NOTE: The Ernitec VMS 7.X software is not compatible with Ernitec VMS 6.X or earlier licenses. If you are upgrading from Ernitec VMS 6.X or earlier, it is important to update the license key before continuing to install the software. If the software is upgraded before the license key is updated, all recorder specific information (including profiles and stored material) will be lost. The VMS version needs to be 6.2.1 or higher to accept a VMS 7.x license.

To get a license key:

- Start System Manager. The License Information dialog box is automatically shown when no license key has been specified.

On the **System** tab, under **Licenses**, double-click the recorder that you want to update.

- In the License Information dialog box, copy the MAC address and send it to licensing@Ernitec.com. In return, you will receive the license key as a text file.
- Click **Import license from file**.
- Click **OK**. The system is updated immediately.

NOTE: The default unregistered state that allows the use of one IP camera has been time limited. The unregistered state can be active for up to 60 days, after which a valid license key is required. Unless a valid license key is not added to the system within 60 days after the installation, the system will cease to operate.

NOTE: For information on acquiring VCA feed source licenses, please refer to *Installing VCA Feed Source Licenses*.

SETTING UP THE SYSTEM

After connecting the cameras and other devices to the recorders, configure the system settings and add user accounts and user profiles.

To configure the system:

- Start System Manager locally or over a network (click the **System Manager** icon on the desktop).
- Add recorders to the system and configure their settings on the **Recorders** tab.
- Add user profiles on the **Profiles** tab.
- Add user accounts on the **Users** tab.
- Install the client programs on the end users' computers. See *Installing Client Programs*.

For more information about how to configure the system, see the *Administrator Guide*.

INSTALLING DEVICES

INSTALLING IP CAMERAS

You can connect supported IP cameras and video servers to a recorder over a TCP/IP network. An IP camera has a built-in component for capturing video images. The camera is connected directly to a local area network, and it has its own IP address.

You can also use video servers to change analog cameras into IP cameras. Video servers are also connected directly to the local area network, and they have their own IP addresses.

Depending on the software license, you can connect analog and IP cameras to the same recorder. Alternatively, all cameras can be IP cameras.

For a list of supported cameras, see the document *Supported IP Cameras* on that can be accessed from Ernitec Extranet.

Please see the *Administrator Guide* for instructions on installing IP cameras to the system.

INSTALLING PTZ DRIVERS FOR IP CAMERAS

The recorders support the PTZ (pan, tilt, and zoom) functions for IP cameras and video servers.

It is important to note, that for most IP dome cameras, the dome functionality is installed simultaneously with the camera driver through **automatic camera search** or **IP camera finder**. Please see the *Administrator's Guide* for further information.

In some cases, however, especially for some older camera models, the PTZ functionality driver needs to be installed separately. For information about these camera models, see the documents *Supported IP Cameras* and *Supported Analog Dome Cameras & Plugins* on the VMS Installation medium.

To install the PTZ driver for a camera not supported through automatic camera search or IP camera finder:

- To install the driver, double-click the driver installer <driver name>_XX.msi, where XX is the version number. For information about

the drivers, see the document *Supported Analog Dome Cameras & Plugins* on the VMS Installation medium.

- Click **Next** until you get to the **Destination Folder** dialog box. Make sure that you select the same folder as where the recorder is installed.
- Click **Next** until the VMS Driver Configuration tool starts. Configure the driver as follows:
 - Select the option **Show Dome camera drivers**.

From the drop-down list, select the driver that you just installed.

Type the number of the camera in the **DVR camera ID** box.

Click **Configure** and do the following:

- In the dialog box that is shown, click **Add Connection**.

In the **Connection Name** dialog box, type a descriptive name for the connection and click **OK**.

Click **Add Camera**.

Type or select at least the necessary settings. See more details below.

Click **OK** and **Close** to close all dialog boxes.

NOTE: In the camera setup dialog box, type or select at least these settings:

- Type a descriptive name for the camera.
- Type the IP address of the camera (and the port).
- Type the user name and password that are in the camera's settings (by clicking **Launch camera setup application**, you can access the camera's settings). The user name and password that you type here are written to the recorder's settings.
- For some cameras, you must choose the camera's mounting type, ceiling or desktop. If you select the incorrect option, the camera will move to the opposite direction when the user tries to control it.
- For some cameras, you can click **Menu** to access additional camera settings. The menu opens on the video window. To see the menu, open a web browser and type the IP address of the camera in the address bar. Use the **Up**, **Down**, **Left**, and **Right** buttons to navigate in the menu.

- If the PTZ camera is connected to an Axis video server, select the **Camera connected to Axis video server** check box. Then select the number of the camera input (ID) on the Axis server.
- To make sure that the camera's IP address is correct and to access other camera settings that are not shown in the dialog box, click **Launch camera setup application**.
- Some models have a **Reset Camera** button for restarting the camera.
- Some models (some Bosch PTZ IP cameras) require additional ports to be opened to the recorder's firewall. Please refer to the camera manuals for further information.

NOTE: The PTZ driver installs only the camera control functions. For instructions on how to install and configure an IP camera or a video server, see Installing IP Cameras.

NOTE 2: The Axis PTZ driver makes it possible to control not only the Axis 213 PTZ IP camera, but also analog PTZ cameras that are connected to an Axis 241Q or 241S video server. Note that the dome cameras must be supported by Axis. Contact Axis to get the PTZ camera driver and load it on the Axis video server.

INSTALLING AUDIO DEVICES

Audio recording requires the following:

- A digital recording interface, for example, a PCI audio card or a USB device
- A preamplifier, if necessary

For more information about suitable audio devices, please contact the system supplier.

To install an audio device:

- Connect the device to the recorder.
- Install the audio driver (capture driver).

For more information about installing an audio device, see the manual supplied with the device.

To configure audio channels:

- Start System Manager.

In Hardware Settings, on the Audio tab, click Add.

Select the capture driver from the list.

Select one of these options:

- **Mono.** Select to use two mono channels.
- **Stereo.** Select to combine two mono channels into one stereo channel.

Click **OK**.

For information about how to change audio detection settings, see the *Administrator's Guide*.

INSTALLING AUDIO COMMUNICATION

You can connect a call button, a microphone and a speaker to a recorder and use them as a door or gate phone. Each recorder can have one such audio communication channel. Audio is transmitted over a TCP/IP network.

When the call button is pushed, the system sends a call signal to the Workstation program. This is shown by an animated telephone icon on the user's desktop and a ringing sound.

The user can then answer the call, which opens a direct, two-way communication channel between the user and the person who pushed the call button.

The users can also open the communication channel from Workstation when there is no call signal.

To connect the devices:

- Connect a call button or an equivalent device to one of the digital inputs on the recorder.

Make sure that the user's workstation has audio hardware that supports two-way audio. For example, the audio device can be an integrated sound card.

Connect a microphone and a speaker or an earphone to the recorder and to the user's workstation.

To set up audio communication:

- Start System Manager.

In **Hardware Settings**, on the **Audio Communication** tab, select the capture driver and the playback device used on the recorder.

In **Audio Communication Settings**, type a name for the communication channel (or use the default name).

Type a general description and an administrative description of the channel. All users can see the general description, whereas only system administrators can see the administrative description.

Select the digital input that the call button is connected to.

INSTALLING ANALOG PTZ CAMERAS

***NOTE:** Supported dome camera models are listed in the document [plugin.pdf](#) on the VMS Installation medium.*

HARDWARE INSTALLATION

Connect the dome camera to the RS-232 serial port of the recorder and the video cable to a BNC connector. Because most dome cameras use the RS-485 or RS-422 standard for transferring control data, use an RS-232/RS-485 or RS-232/RS-422 converter.

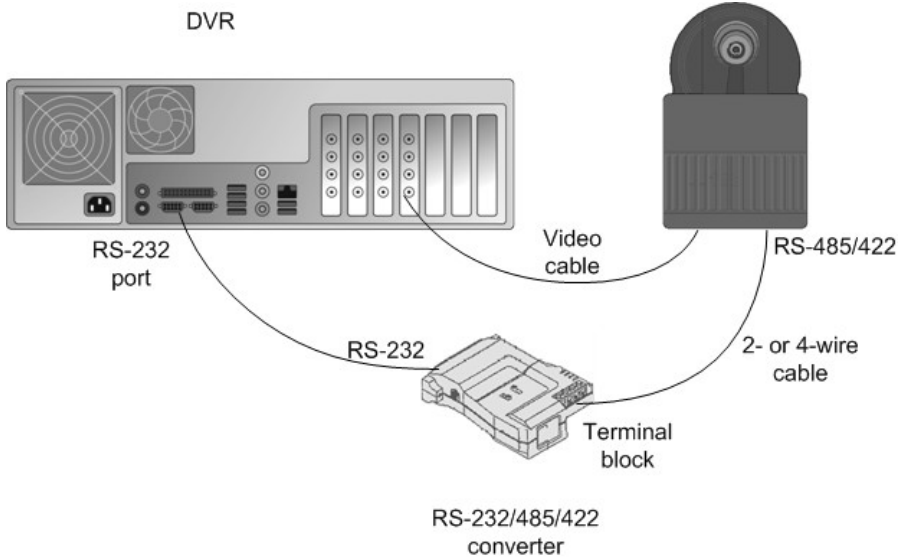

Connecting a PTZ camera to a recorder.

For wiring instructions, see *Wiring*.

INSTALLING MULTIPLE PTZ CAMERAS

Use one of these options to connect more than one PTZ camera to a recorder:

- A multiport serial board.
- A daisy chain configuration (each camera is connected in a series from the previous camera).
- A daisy chain configuration together with a multiport serial board

NOTE: *If you connect more than one camera directly to the same serial port (star configuration), the control signal from the recorder can become too weak.*

USING A MULTIPOINT SERIAL BOARD

You can use a multiport serial board to connect more than one PTZ camera to a recorder. Usually, such a board is put into one of the PCI slots of the

recorder or plugged to a USB port. Use a board that has RS-422/485 ports. Connect the cameras to the ports by using 2- or 4-wire connectors.

Multiport serial boards are available, for example, from Moxa.

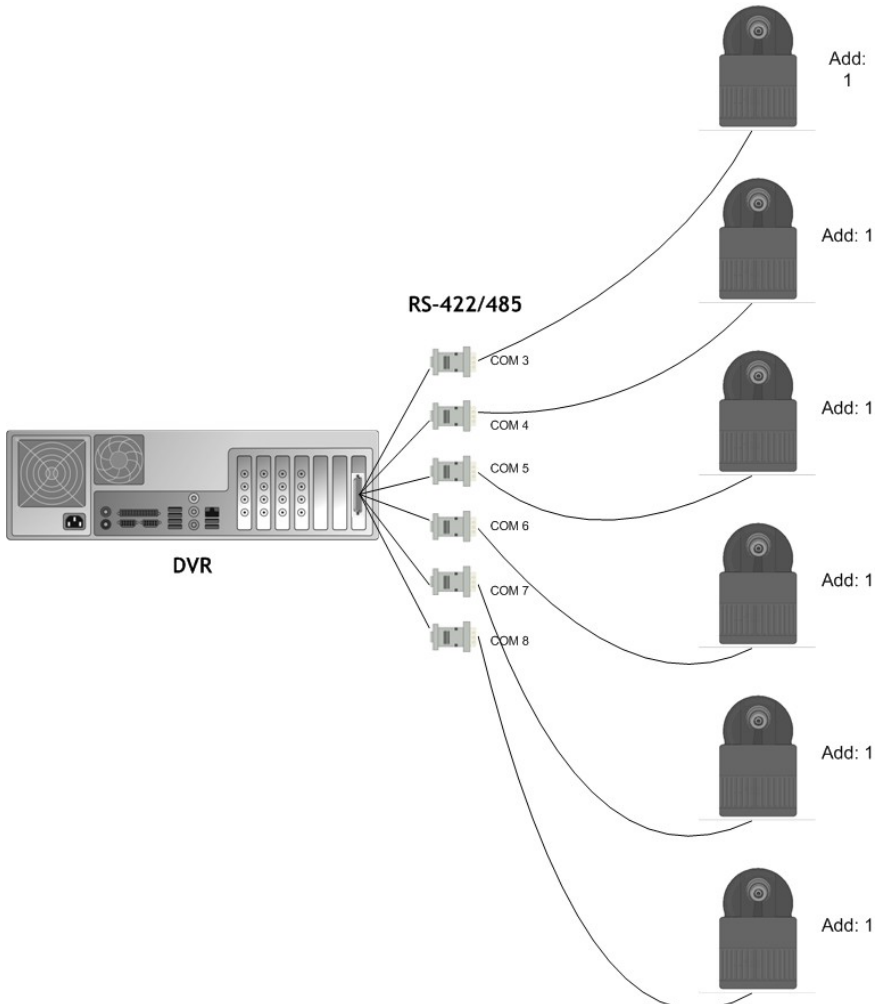

Using a multiport serial board to connect multiple PTZ cameras

USING A DAISY CHAIN CONFIGURATION

In a daisy chain configuration, the cameras are connected in one line.

It is important that you do these:

- Give each camera a unique address by using the switches or dials on the camera.
- Terminate the last camera in the chain.

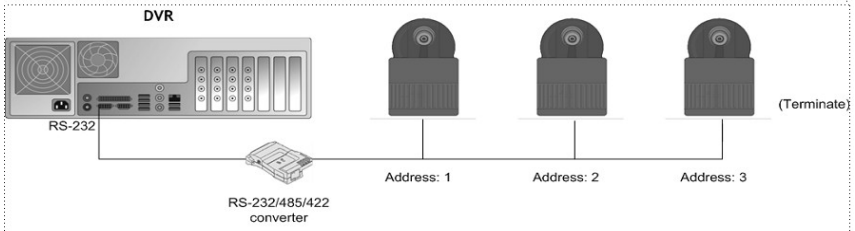

Using a daisy chain configuration to connect multiple PTZ cameras

COMBINATION

You can also use a configuration that combines a multiport serial board with daisy-chained cameras.

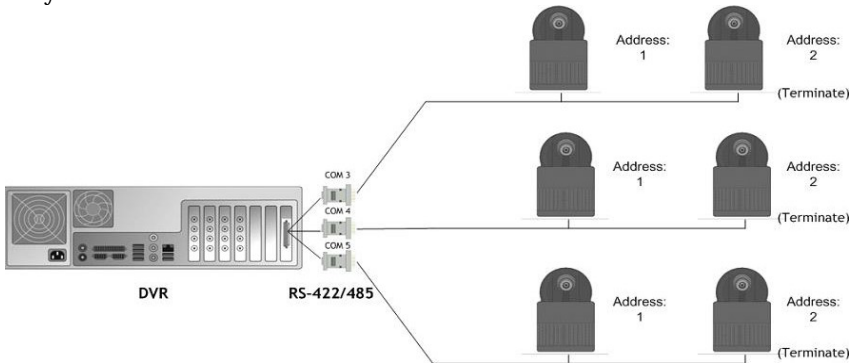

Using a combination of daisy chained cameras with a multiport serial board

WIRING

RS-232 pin assignment

Connect the RS-232/RS-485 or RS-232/422 converter to the RS-232 port on the recorder using a 9-pin D-connector. If you make the connections yourself, connect the conductor wires as shown in this table.

Recorder	RS-232 port	RS-232/RS-485 or RS-232/422 converter
Pin	Signal	Signal
1	Not used	
2	Receive Data (Rx)	Tx
3	Transmit Data (Tx)	Rx
4	Not used	
5	Signal ground	Signal ground
6	Not used	
7	Not used	
8	Not used	
9	Not used	

SIMPLEX WIRING

Wire the dome camera to the RS-232/RS-485 converter. Connect pins as shown in this table and figure.

RS-232/RS-485 converter	Camera pin
Tx-	Rx-
Tx+	Rx+

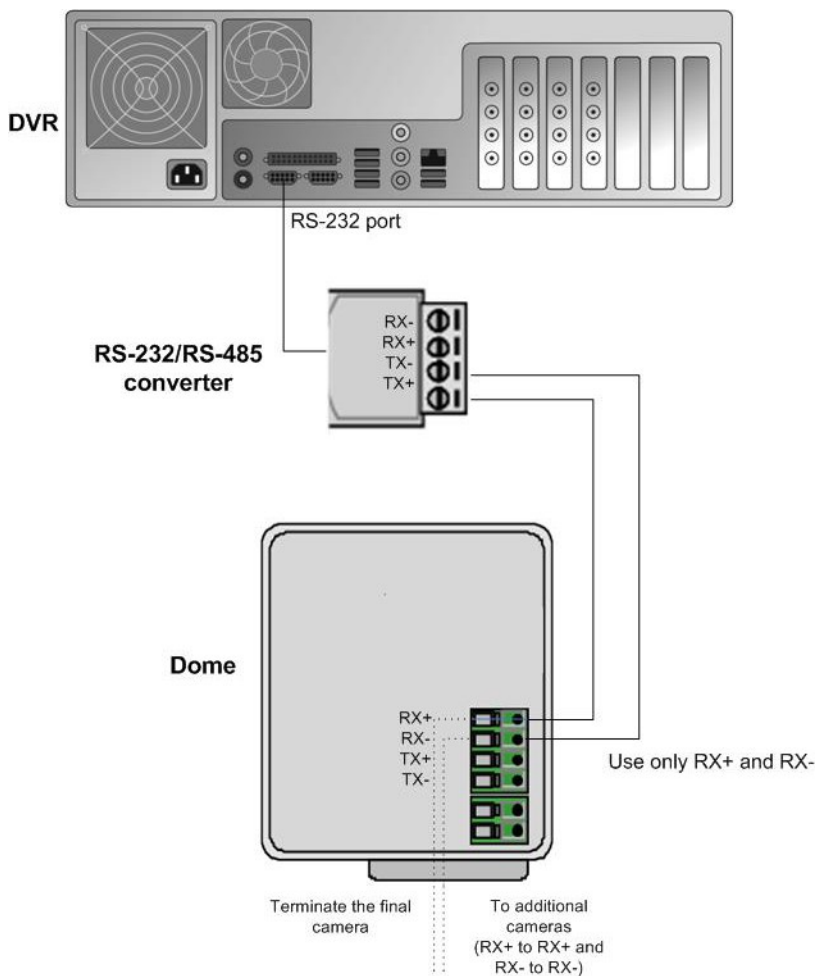

DUPLEX WIRING

Wire the PTZ camera to the RS-232/RS2-485 converter. Connect the pins as shown in this table and figure.

RS-232/RS-485 converter	Camera pin
Tx-	Rx-
Tx+	Rx+
Rx-	Tx-
Rx+	Tx+

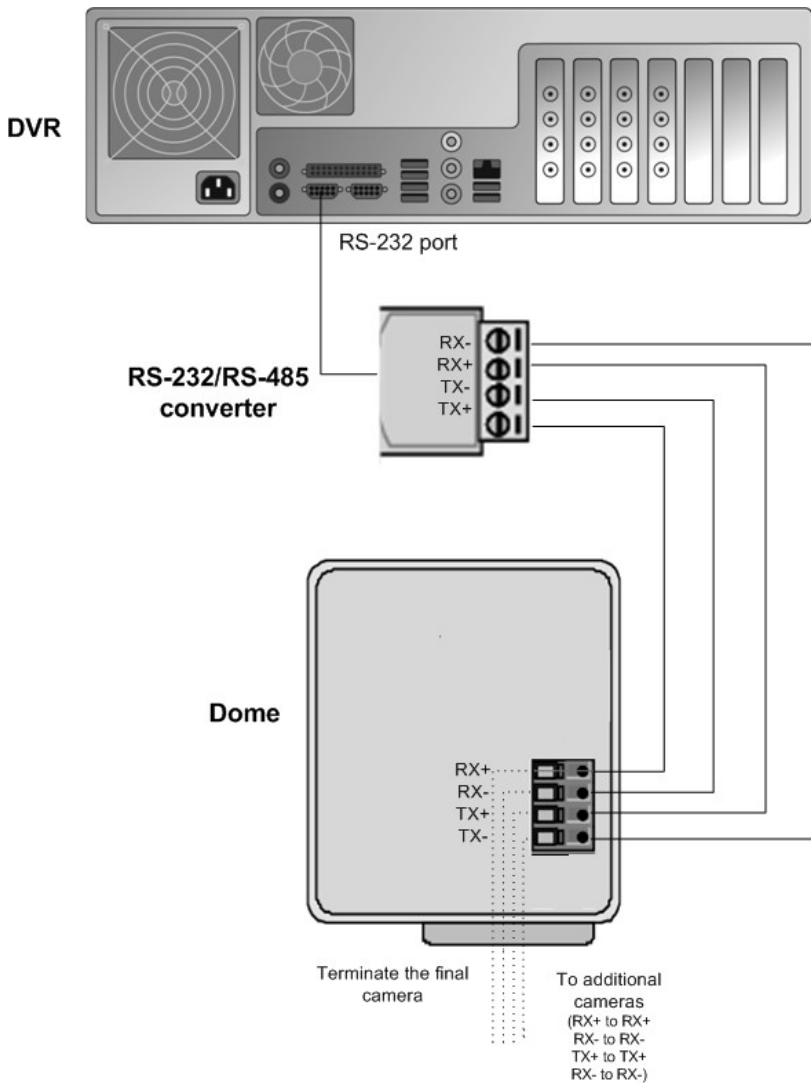

CAMERA ADDRESSES

When cameras are daisy chained, each camera must have a unique address. Set the address by using the switches or dials on the camera. See the camera manual for more details.

NOTE: *Terminate the last camera in each chain by using the termination switch or jumper on the camera.*

INSTALLING ANALOG PTZ CAMERA DRIVERS

Available PTZ camera drivers are on the VMS Installation medium, in the folder Plug-in.

To install the PTZ camera driver:

- Double-click the driver installer <driver name>_xx.msi, where xx is the version number. For more information about the driver names, see the document plugin.pdf on the VMS Installation medium.
- Click **Next** until you get to the **Destination Folder** dialog box. Make sure that you select the same folder where the recorder is installed.

Click **Next** until the VMS Driver Configuration tool starts. Configure the driver as follows:

- Select the option **Show PTZ camera drivers**.

From the drop-down list, select the driver that you just installed.

Type the number of the camera in the **DVR camera ID** box. The number is the same as the number of the video input and the number of the camera in the client programs.

Click **Configure** and do the following:

- In the dialog box that is shown, click **Create New**.

In the **Connection Setup** dialog box, type a descriptive name for the connection, and select the COM port that the PTZ camera is connected to. Then click **OK**.

In the **Choose Connection for the New Camera** dialog box, select the connection and click **OK**.

In the camera setup dialog box, do the following:

- Type a descriptive name for the camera.

Type the camera's address in the **Camera address** box. The camera address is set by using the switches or dials on the camera. Usually, the default address is **0** or **1**.

Close all dialog boxes.

For more information about the drivers, see the document *Supported Analog PTZ Cameras & Plugins* on the VMS Installation medium.

INSTALLING EXTERNAL DEVICES FOR ANALOG DOMES

External devices - such as joystick controllers for dome cameras - can be configured through Workstation. The control devices can be configured to support customized controls for axis movement and buttons / keys.

Please note that the driver for the external device has to be installed in the system. The drivers for Pelco KBD300A keyboard and DirectX compatible control devices (such as DirectX joysticks) are included in the default installation.

Please see *Ernitec VMS series User's Guide* for further information on configuring external devices.

PELCO KBD300A KEYBOARD

The system supports the Pelco KBD300A keyboard, which you can use to control PTZ cameras locally or over a TCP/IP network. The keyboard has a joystick, a numerical keypad, and keys for different functions. You can use the keyboard to pan, tilt, and zoom a PTZ camera. In addition, you can move a PTZ camera to a preset position or start a camera tour.

The Pelco KBD300A drivers are included in the standard installation package, and the keyboard can be installed directly through the Workstation application. Please see *Ernitec VMS series User's Guide* for further information on configuring Pelco KBD300A the keyboard.

Please note that PELCO keyboard is only supported by the *Workstation* application, it is not supported by the *EasyView* application

CONNECTING DIGITAL INPUTS AND OUTPUTS

You can connect external devices to the digital inputs and outputs of a recorder by using an I/O card. Available cards and the default configuration depend on the recorder model. For more information about the cards, see the folder Manuals on the VMS Installation medium.

SETTING UP DIRECTX PTZ JOYSTICKS

Any DirectX joystick can be used, but you can contact your supplier for a list of devices that are proven to work best.

Connect the DirectX device to your computer and wait for the driver to be installed.

Calibrate the joystick in windows. Press “Start” and write “USB game” and then select the “Set up USB game controllers” option

Select the device from the list and click “properties”

Select “settings” and then “Calibrate” and follow instructions.

After this, start *EasyView* application and then configure the input device settings in EasyView to get the joystick working. Please see the *EasyView User Guide* for further details.

SETTING UP THE HARDWARE WATCHDOG

MiraCap capture cards have a hardware watchdog, which restarts the computer if it stops responding. The watchdog is not in use by default.

To use the watchdog:

If the computer has an external reset cable, connect the cable from the PC's reset switch to one of the two watchdog pins on the capture card.

Connect the reset cable provided with the capture card from one of the two watchdog pins on the capture card to the reset pin on the mother board. The location of the reset pin on the mother board depends on the type of

motherboard. For more information, see the motherboard manual.

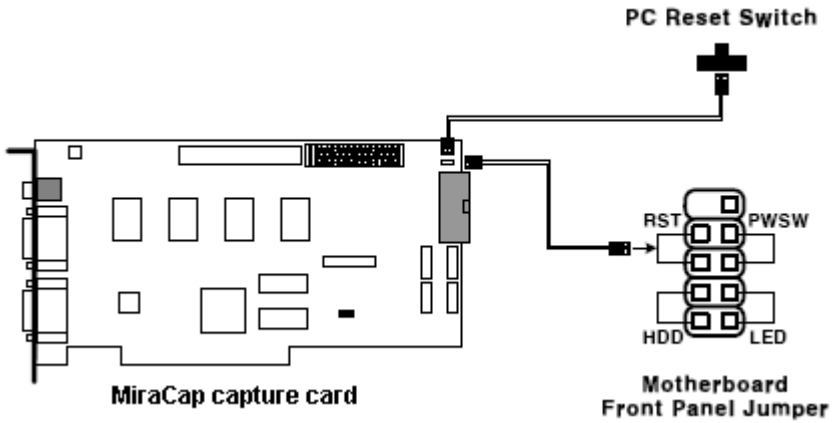

A sample watchdog connection

INSTALLING CLIENT PROGRAMS

You can use the client programs locally on the recorder or on a computer that has a network connection to the recorder system.

INSTALLING THE .NET FRAMEWORK

Install DirectX 9.0c, .NET Framework and all critical updates on client computers.

To install .NET Framework:

- Click **Start** and then click **Windows Update**.

Install these components (you cannot install all at one time):

- .NET Framework 3.5, 4.0 & 4.5
- Security updates and critical updates

Start **Windows Update** again until you have installed all the necessary components.

INSTALLING THE CLIENT PROGRAMS

To install the client software:

- Unzip the installer package somewhere on the machine where you want to do the install.

NOTES:

- Clients can be installed either with the VMS installer file Release_7XX_EASYVIEW_XXX.exe OR with an available “EasyView - only” installer file.
- SQL Server is not needed for client install, so use the “Limited” EASYVIEW installer file for installing only the clients.
- Start the VMS installer by double clicking the installer file Release_7XX_EASYVIEW_XXX.exe

- In Welcome to the VMS Installation, click **Install**.
- Installer next installs SlimDX to the system. This takes approximately 30 seconds
- After this, the “Welcome to VMS Setup Wizard” is displayed. Click **Next**.
- In the next screen, you can select various installation options
- When you are installing clients, uncheck the “recorder” option and make sure that the “Applications” option is checked.

If you want the Workstation application, choose it from the list. You can also define if Workstation, EasyView or System Monitor should start automatically

If you want firewall exceptions set automatically for Windows Firewall, open the menu next to **Set firewall exceptions** and select **Will be installed on local hard drive**. Do not select this option if you are not using Windows Firewall.

Click **Next**.

Select the destination folder and click **Next**.

In the Installation Configuration dialog box, specify the IP address or DNS name of the Master Server. The Master Server is the Recording Server where all system configuration data is stored when more than one recorder is used in the same system. (This dialog box is not shown if only the recorder is installed). If the Master Server is the local computer, use the default value 127.0.0.1. Then click **Next**.

Select the video standard and click **Next**. Then click **Install** to start the installation.

When the recorder has been installed, the dialog box “Completed the VMS Setup Wizard” is shown.

Click **Finish**.

COMPATIBILITY

Ernitec 7.x servers are compatible with Ernitec 7.x and 6.x slave Recording Servers. The Master Server always needs to be same or higher version than the slaves.

When upgrading from 6.x to 7.x, update the license first and install it to 6.2.5 or later release server. After this you can upgrade server to 7.x version. Drivers or plugins might require updating after the major version upgrade.

UPDATING

UPDATING A RECORDER

To update a recorder, first remove the current software version and then install the new software version.

IMPORTANT: Backup system settings and recorder settings in System Manager before removing the current version and then restore the settings after the update is completed.

To remove the current recorder version:

- Click **Start**, point to **Settings**, click **Control Panel**, and then double-click **Uninstall programs**.

Click EASYVIEW and then click **Uninstall**.

To install the new recorder version:

Follow the instructions in *Installing The Recorder Software*.

UPDATING CLIENT PROGRAMS

The client programs are updated automatically to the same program version as the Master Server when they are started.

To manually update the client programs, first remove the current version and then install the new version by running the VMS installer.

To remove the current version:

- Click **Start**, point to **Settings**, click **Control Panel**, and then double-click **Uninstall programs**.

Click EASYVIEW and then click **uninstall**.

To install the new version:

- See *Installing The Client Programs*.

UPDATING SLAVE SERVERS FROM MASTER SERVER

Updating slave Recording Servers remotely through the Master Server has been possible since Ernitec VMS 6.2.5.

To update slave Recording Servers remotely, first update the Master Server to the latest version. In the System Manager, update the licenses for the slave recorders through the 'Licenses' list in the 'System' tree. After updating the licenses, you can update the slave servers remotely by using the 'Update recorders' tool in System Manager.

NOTE: This feature is available only if the slave recorders have Ernitec VMS 6.2.5 or later. In case the slave recorders have an earlier version, you need to install Ernitec VMS 6.2.5 or newer on them manually to enable remote server updates.

NOTE: In some cases, the slave recorders might need restart of PC after remote software update. Monitor the slave recorders after remote update, and if they do not return online in 10 – 15 minutes, restart the PC they are running on.

UPDATING COMPONENTS

In addition to camera drivers and EasyView Client Plugins, since version 7.2.0 it is possible to update also metadata drivers from system manager.

EasyView Plugins are updated by removing the old version and adding a new version *.spi file to the system.

Metadata drivers offer the possibility to update the drivers to whole system or only selected recorders.

Contact Ernitec for more information on available metadata drivers and updating them.

FLASH MEMORY BACKUP / RESTORE

Ernitec VMS includes an automatic flash memory based backup and restore functionality (“ABUR”). This feature is only available on servers delivered by Ernitec Ltd.

The flash memory backup and restore functionality is intended for situations in which the operating system and hard disk have failed and the server hard disk needs to be re-formatted or replaced.

The automatic flash memory functionality can backup and restore the following:

- Windows OS
- Ernitec VMS software
- Ernitec VMS license
- Recorder configuration files

The automatic flash memory functionality does not include the following:

- Windows OS updates made after recorder delivery
- Any VMS software updates made after recorder delivery
- Any driver updates made after recorder delivery

NOTE: *It is important to note that the automatic restore function restores the VMS software version that was delivered with the recorder. The same applies to IP camera drivers. If the recorder has been updated or new drivers installed, the software needs to be updated after restore, and the IP camera drivers will need to be reinstalled.*

NOTE: *It should be noted that the first backup is done on the midnight of each day (unless changes are made to the configuration during the hour before midnight, in which case backup is delayed until the next day).*

FLASH MEMORY BACKUP

The flash memory functionality automatically backs up the recorder configuration and license files at installation and after that each time there are changes in them. The recorder automatically handles all steps of the process, and there is no need for the users to do anything to enable the functionality.

FLASH MEMORY RESTORE

In case of operating system being corrupted or hard disk failure, the system administrator may need to restore the system from the automatic backup files. The process is mostly automatized, but the user needs to perform some steps.

To use the flash memory, restore functionality:

- Set the computer BIOS to boot from USB devices. Ensure that there are no other USB memory devices or other boot media connected.

Once the Windows loader starts, select either:

Format the hard disk – Use this option to format a hard disk that has already been in use. This option should be used when the operating system has been corrupted and the hard disk needs to be reformatted.

Blank installation – Use this option to restore the system to a blank hard disk. This option should be used when the hard disk has been changed and a blank one has been installed on the computer.

Once the Windows installer starts, select the appropriate country, time zone, and language options.

Once the VMS software loader starts, choose either:

Don't install VMS – Choose this option if you do not want to install Ernitec VMS software.

Drivers are installed properly. Continue to install VMS

– Choose this option if want to install Ernitec VMS software and have checked that the capture card drivers (only in analog or hybrid DVRs) are installed correctly

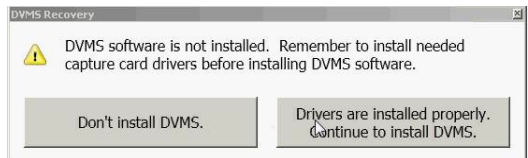

NOTE: *If you need to install capture card drivers, you can leave this dialogue on the background while you install the drivers.*

In most cases, capture card drivers are installed automatically from the OS image during flash memory restore process, but you should ensure that the installation has succeeded. Please Installing Capture Cards for information on checking whether the capture cards are correctly installed.

In no case should you continue installing the software if your system uses capture card drivers but they have not been correctly installed, as installing them later may result in a broken configuration when the configuration files are restored.

After the recorder software has been installed, the configuration files and license information is automatically restored.

When rebooting the computer, remember to go to the BIOS to disable booting from USB devices.

ERNITEC GATEWAY SERVER INSTALLATION

Ernitec WebClient is a browser-based application that is used for viewing video from Ernitec recorders over a network. Ernitec WebClient uses the same user profiles, user names, and passwords as Ernitec System Manager and EasyView or Workstation client programs.

To be able to use Ernitec WebClient, the Ernitec Gateway server must be first installed on a computer running a HTTP (web) server. Ernitec VMS recording software is not required on the server. The Gateway server needs to be able to connect to the Ernitec VMS Master Server.

MINIMUM SYSTEM REQUIREMENTS

Client:

- Internet Explorer 6 or Mozilla Firefox 2.0 or newer
- Java Runtime Environment (latest version recommended for security reasons)

Server:

- Windows 7 Enterprise, or Windows 2008/2012 Server
- HTTP server software
- Intel i3 processor, or better
- 4 GB of RAM

NOTE: *Please note also that the minimum system requirements are recommended for mostly live viewing. If multiple users access the same WebClient server simultaneously mainly for search and play back functions, a more powerful processor is required.*

SYSTEM RESTRICTIONS

The Ernitec VMS Gateway server can be installed on any Microsoft Windows 7 Enterprise, or 2008/2012 Server that meets the system requirements. Ernitec VMS software is not required on the server.

The Gateway server has a default license controlled limitation of 32 simultaneous streams for all WebClient connections. The limit is universal and user independent; if, for example, User A has 30 open video streams and

User B has 2 open video streams, neither can open any more streams unless one or more of the currently open streams are closed.

INSTALLING THE ERNITEC GATEWAY SERVER

To install the Ernitec Gateway server:

- Double-click the **Release_XXX_Gateway_XXX.exe** installation package to start the installation.

After the **VMS Gateway Setup** screen has loaded, select the destination folder and click **Next**.

Type the **SMServer IP address** (the IP address of the Master Recorder) into the **SMServer IP** field.

Click **Next**

When the software has been installed, click **Finish**.

VERIFYING THE INSTALLATION

To verify that the server has been correctly installed:

Open a compatible web browser and type the following address:

http://[WEBCIENT SERVER URL]:[PORT]/

For example, if the WebClient server is on the same computer:

http://localhost:9999/

If the server is correctly installed, the logon screen is displayed. Type a user name and password in the corresponding boxes and click **Log On**. The user name and password are set in the Ernitec System Manager program.

STREAMING OPTIONS

The users can view the WebClient streams in JPEG format (default) or in the native format in which they are received by the recorders. This does not require any action on the server side: the users can decide to view the streams in native format by adding *?video=native* to the end of the WebClient URL.

For example, if the WebClient server is on the same computer:

http://localhost:9999?video=native

INSTALLING EASYVIEW PLUGINS

In Ernitec 7.x, EasyView plugins can be added to system from system manager.

EasyView plugins are added to system manager as *.spi files from the system manager first tab – Add-ins – install client plugin.

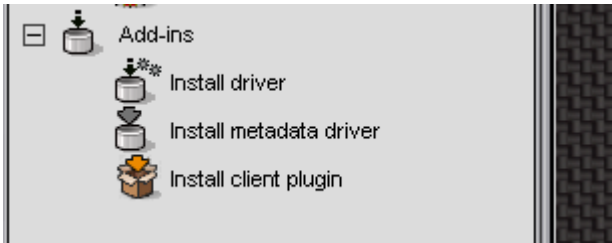

Each plugin needs to be enabled in the master license. If the plugin is not in the license, it can be installed, but will not be deployed to the EasyView clients of the system.

After plugin is installed to System Manager, each EasyView client that logs in to this SMServer, gets the updated plugin next time the client is started.

Development of custom plugins is possible. Contact Ernitec for further information.

INSTALLING VCA COMPONENTS

Ernitec provides configuration services for the VCA functionality; for further information, please contact Ernitec.

This section of the manual only covers installing basic VCA functionality. Please refer to the *Ernitec VMS VCA Installation and Configuration Guide* for more information on using VCA with Ernitec products.

Ernitec VMS supports both analog and IP based VCA services. The VCA functionality allows using VCA metadata for creating alarms based on metadata information. This functionality requires separate licensing (see below).

If you are using the VCA functionality through analog capture cards, please see *Supported Capture Cards For Analog VCA* for a list of supported capture cards.

Installing VCA components to a Ernitec VMS system requires the following steps:

- Installing a database to each Ernitec VMS recorder with VCA streams
- Adding the license keys:
 - Adding VCA channel license keys to each recorder with VCA streams
 - Adding capture card / IP capture specific licenses to each recorder with VCA streams
- Configuring the VCA cameras
- Configuring alarm events based on VCA messages in System Manager

These steps are further discussed below.

IMPORTANT: *It is important to note that the licenses and the database are recorder specific and need to be installed on the recorder(s) on which the VCA feeds are situated. If a system contains multiple recorders, the licenses and database must be installed separately on each recorder with VCA feeds.*

NOTE: *VMS release 7.2.0 and later comes pre-installed with drivers for VCA metadata analysis and metadata enrichment. The drivers can be updated later from system manager application.*

DATABASE INSTALLATION

Install MS SQL Server with *ExpressInstaller.exe* or with the built in SQL installer of the VMS installer.

The database must be installed separately on **each recorder** with VCA feeds.

ADDING LICENSE KEYS

The VCA functionality requires two types of licenses:

- VCA channel licenses for each VCA camera feed. This is included in Ernitec VMS Enterprise versions.
- VCA feed source license for each VCA source: a license for each capture card with VCA feeds (if analog cameras are used), and a license for IP VCA capture (if IP cameras are used).

The VCA license keys can be acquired at the same time as the recorder license key (see

Obtain a License Key for further information).

INSTALLING VCA CHANNEL LICENSES

The recorder license must include a VCA channel licenses for each VCA camera feed. VCA channel licenses can be added during default VMS license addition or separately (see

Obtain a License Key for further information).

INSTALLING VCA FEED SOURCE LICENSES

The system requires a VCA feed source license for each VCA source; i.e. for each capture card with VCA feeds and for IP camera based VCA feeds. These licenses can be acquired by contacting **orders@Ernitec.com** and sending a feed source specific *hwguid.txt* file for each capture device (capture cards and IP capture) for which you want to add VCA channels.

To acquire VCA feed source licenses:

- Start the *VCA Configurator* (in the EASYVIEW folder)

NOTE: Starting *VCA Configurator* automatically pauses *Ernitec VMS recorder* functions. Exiting *VCA Configurator* automatically restarts the recorder functions.

On the upper side of the *VCA Configurator* window, select the devices for which you want to create *hwguid.txt* files. Each device will have its own *HWGUID* file.

Contact Ernitec to get the VCA capture card licenses. Attach the device specific *hwguid.txt* files to the mail.

After getting the capture device specific licenses, use *VCA Configurator* to import each license.

CAMERA CONFIGURATION

After importing the licenses, you can configure the cameras with VCA functionality in the *Camera* tab in the *VCA Configurator* application.

To configure VCA zones and calibration:

- Calibrate the VCA functionality.
- Create zones and rules.
- Test the functionality of your rules.

As the configuration rules and parameters are extremely flexible and it is easy to do user errors, Ernitec can take no responsibility for the functionality of any user specified configurations. However, Ernitec provides configuration services for the VCA functionality.

VCA INSTALLATION

The VCA based alarms are configured through *System Manager* through the default alarm management functionality. The VCA events are used as alarm start and end triggers.

Please see the *Ernitec VMS Administrator Guide* for information on creating alarms.

SUPPORTED CAPTURE CARDS FOR ANALOG VCA

The VCA functionality is supported by the following cards: MiraCapO1612, MiraCapO1625, MiraCapO1625D, MiraCapOC0825H and MiraCapOC1625H.

COPYRIGHTS

The contents of this document are provided "as is", and Ernitec Ltd reserves the right to modify this document as necessary and without prior notice. Any products, services, or features discussed in this document are subject to change by Ernitec Ltd. or a third party when applicable. Ernitec Ltd does not guarantee the availability of all products, services, or features.

© Ernitec Ltd. All rights reserved.

No part of this document may be reproduced for any purpose, even in part, without an explicit permission from Ernitec Ltd.