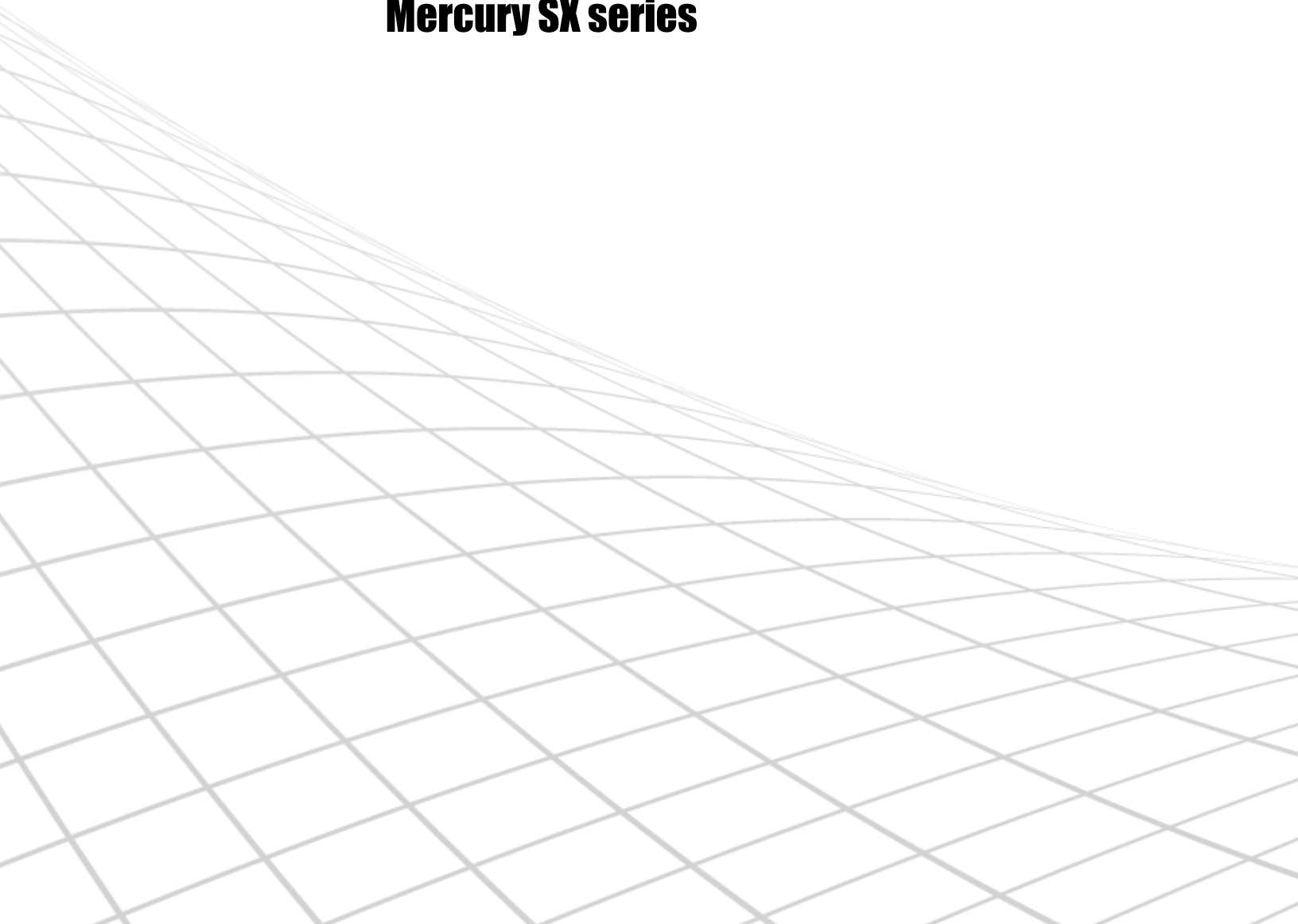


**ernitec**

# **Installation Guide**

**Mercury SX series**



## Caution and Preventive Tips

### Important Information

Before proceeding, please read and observe all instructions and warnings in this manual. Retain this manual with the original bill of sale for future reference and, if necessary, warranty service. When unpacking your unit, check for missing or damaged items. If any item is missing, or if damage is evident, **DO NOT INSTALL OR OPERATE THIS PRODUCT**. Contact your dealer for assistance.

- Handle with care, do not drop the unit
- Mount the unit in an equipment rack or place it on a solid, stable surface
- Indoor use only. Do not place the unit in a humid, dusty, oily, or smoky site
- Do not place it in an area with poor ventilation or in an area close to fire or other sources of heat. Doing so may damage the unit as well as cause fire or an electric shock
- When cleaning is necessary, shut down the system and unplug the unit from the outlet before uncovering the top cover. Do not use liquid cleaners or aerosol cleaners. Use only a damp cloth for cleaning
- Always shut down the system prior connecting or disconnecting accessories, with the exception of USB devices






### Copyright

Under copyright laws, the contents of this user manual may not be copied, photocopied, translated, reproduced or reduced to any electronic medium or machine-readable format, in whole or in part, without prior written permission of the company.

### Important Information

Before proceeding, please read and observe all instructions and warnings in this manual. Retain this manual with the original bill of sale for future reference and, if necessary, warranty service. When unpacking your unit, check for missing or damaged items. If any item is missing, or if damage is evident, **DO NOT INSTALL OR OPERATE THIS PRODUCT**. Contact your dealer for assistance.

## Regulation

	<p>This device complies with Part 15 of the FCC Rules. Operation is subject to the following two conditions:          (1) this device may not cause harmful interference, and (2) this device must accept any interference received, including interference that may cause undesired operation.</p>
	<p>This symbol on the product or on its packaging indicates that this product shall not be treated as household waste in accordance with Directive 2002/96/EC. Instead it shall be handed over to the applicable collection point for the recycling of electrical and electronic equipment. By proper waste handling of this product you ensure that it has no negative consequences for the environment and human health, which could otherwise be caused if this product is thrown into the garbage bin. The recycling of materials will help to conserve natural resources.</p> <p>For more details information about recycling of this product, please contact your local city office, your household waste disposal service or the shop where you purchased the product.</p>
	<p>This symbol intends to alert the user to the presence of unprotected “Dangerous Voltage” within the product’s enclosure that may be strong enough to cause a risk of electric shock.</p>
	<p><i>This symbol intends to alert the user to the presence of important operating and maintenance (servicing) instructions in the literature accompanying the appliance.</i></p>
	<p>Compliance is evidenced by written declaration from our suppliers, assuring that any potential trace contamination levels of restricted substances are below the maximum level set by EU Directive 2002/95/EC, or are exempted due to their application.</p>

## **Table of Contents**

<b>1.</b>	<b>Camera Installation.....</b>	<b>4</b>
<b>1.1</b>	<b>Hard Ceiling.....</b>	<b>4</b>
<b>1.2</b>	<b>In-Ceiling (T-Bar) Mounting .....</b>	<b>14</b>
<b>2.</b>	<b>Outdoor Camera Installation .....</b>	<b>22</b>
<b>2.1</b>	<b>Standard/Compact Pendant Mounting.....</b>	<b>22</b>
<b>3.</b>	<b>Cable Gland Installation .....</b>	<b>27</b>

# 1. Camera Installation

## 1.1 Hard Ceiling

The Fixed Dome IP Camera can be installed directly on a wall or ceiling. Please note that the wall or ceiling must have enough strength to support the IP Dome Camera.

**Items Needed:**

Vandal Proof/Lightweight Fixed Dome IP Camera

Ethernet Cable

DC Jack Cable (supplied; only necessary if not using PoE)

Self-tapping Screws (supplied)

Rubber Washers (supplied)

Plastic Screw Anchors (supplied)

**Tools Needed:**

Tool for drilling

(+,-) Screw Drive

Follow the steps below to install the IP Dome Camera:

**Step 1:**

Unpack the Vandal Proof/ Lightweight Fixed Dome IP Camera package and take out the IP Dome Camera.

**Step 2:**

Release the 2 captive Security Screws with the supplied Security Torx and open the Dome Cover.



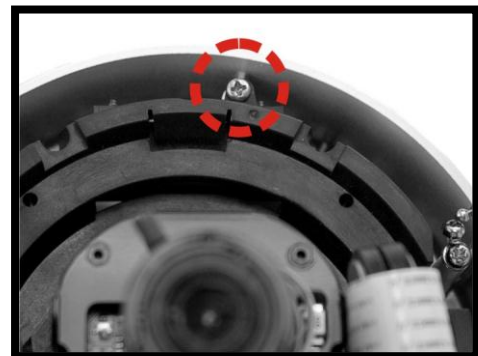
**Figure-1:**  
Captive Security Screw



**Step 3:**  
Press both sides of the Inner Cover and remove it from the Camera Module.



**Step 4:**  
Unscrew the Module-fastened Screw, as indicated in the figure, with the screw driver.



**Step 5:**

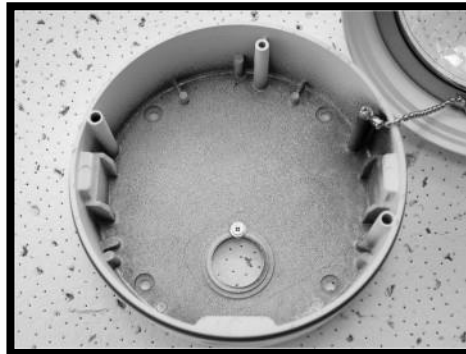
Press the sides of the Snap-on Camera Module, as indicated in the figure, and detach it from the Dome Camera's Housing/ Plate.

**Step 6:**

Mark the positions of the four screw holes on the base of the Dome Camera at the chosen installation location.

**Vandal Proof IP Dome Camera**

Type 1



Type 2



**Step 7:**

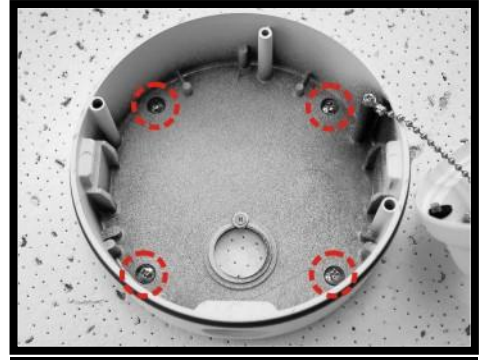
In the marked locations, drill each hole slightly smaller than the supplied Screw Anchors.

**Step 8:**

Put supplied Anchors into these drilled holes.

**Step 9:**

Fasten the Dome Camera's Housing/ Plate with the four supplied Self-tapping Screws.

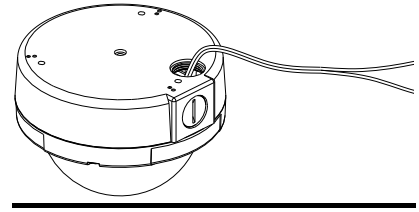


**NOTE:** Be sure to fix the Self-tapping Screws with the Rubber Washers.



**Step 10:**

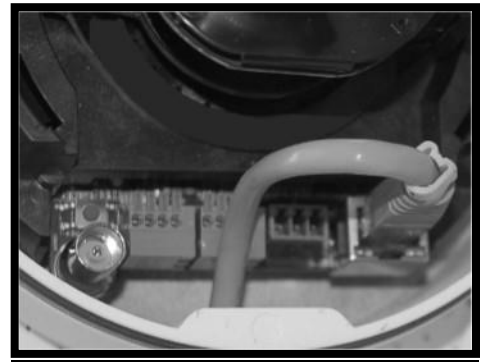
Thread the cables (Power/ Ethernet/ Audio/ Alarm) through either the side conduit entry or back conduit entry, as illustrated. Users may use a coin to screw off the conduit entry block for Vandal Proof IP Dome Camera.



**NOTE:** The Power Cable is omitted if using PoE.

**Connect the Cable(s) to the Unit**

Connect the ports (on the Camera Module) with their cables/wires respectively, as shown in the figures.

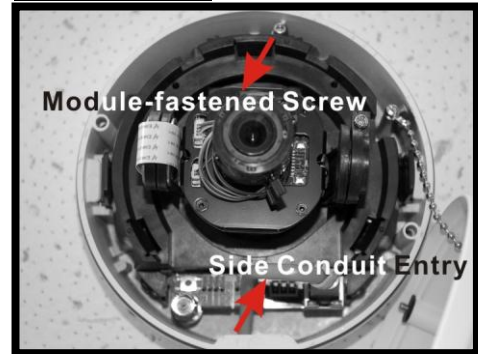


**Step 11:**

Attach the Snap-on Camera Module into/ on the Dome Camera Housing/ Plate, and screw the Module-fastened Screw tightly with the screw driver to secure the Camera Module.



**NOTE:** The terminal blocks should face the side conduit entry for Vandal Proof IP Dome Camera, as shown in the figure.

**Vandal Proof****Step 12:**

Connect the power and network outputs.



**NOTE:** The Power Cable is omitted if using PoE.

**STEP 13:**

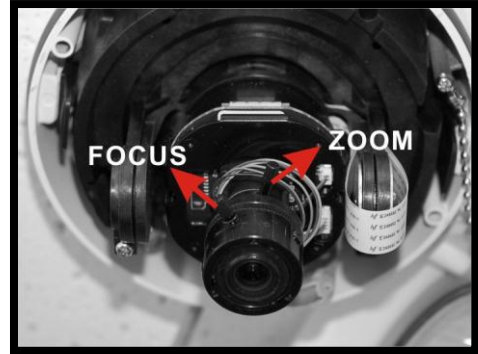
Access the Camera Browser-viewer for viewing images. Please refer to User's Manual for further details. Users can also use the Camera's BNC Connector for video output while choosing BNC as one streaming in advance.

**Step 14:**

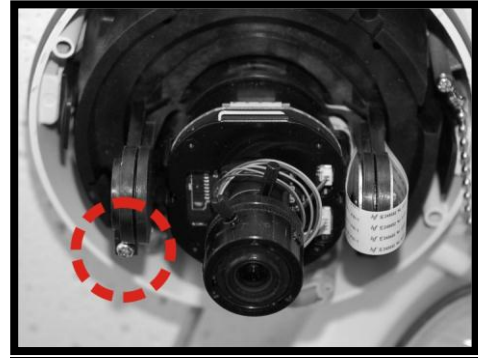
Adjust the Camera's zoom level and focal length via Zoom and Focus Ring Screws.



**NOTE:** The zoom level and focal length might be different with the Dome Cover on, in this case, adjusting zoom level and focal length through the Dome Cover is recommended.

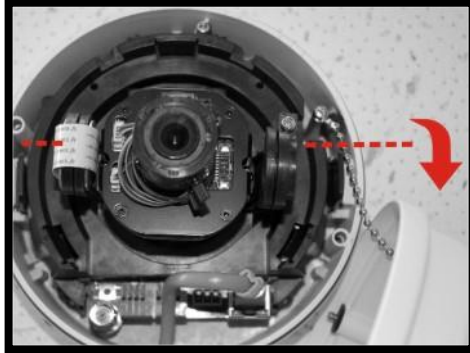


Adjust the Zoo Ring Screw to set the desired zoom; subsequently, modifying the Focus Ring Screw to set the desired focal length.

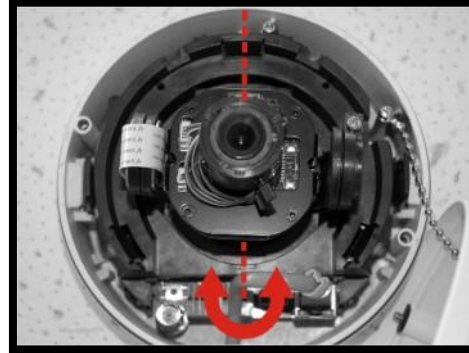


**Step 15:**

Adjust the Camera's Pan/Tilt holder to a desired angle, as shown below. Pan adjustment range is nearly 360°; rotation angle range approaches to 270°. Tilt is adjustable between - 10° ~ 90°.



Pan Adjustment



Tilt Adjustment



**NOTE:** Adjust the Lens carefully within the limits mentioned above, or the cables underneath would be harmed.

**STEP 16:**

Put the Inner Cover back to the Camera Module.



**STEP 17:**

Replace the Dome Cover back.

For Vandal Proof IP Dome Camera, please align the arrow mark on the Dome Cover with the one on the Housing as shown in the top figure.

For Lightweight Fixed Dome IP Camera, please align the arc area on the Dome Cover with the back conduit entry as shown in the bottom figure.

**Vandal Proof****STEP 18:**

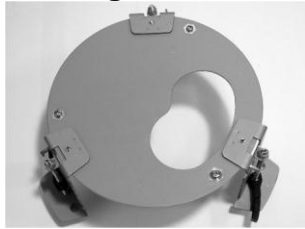
Screw on the two Torx Screws on the side of the Dome Cover tightly to fasten the Dome Cover. Camera installation is complete.



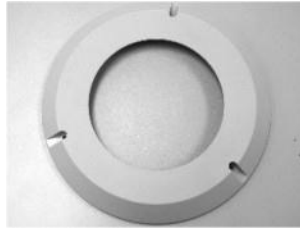
## 1.2 In-Ceiling (T-Bar) Mounting

The indoor Dome Camera can be mounted with the optional accessory: In-Ceiling (T-Bar) Mount. The items and tools needed for in-ceiling installation are listed as follows.

### In-Ceiling Mount Package Contents:



In-Ceiling Mount

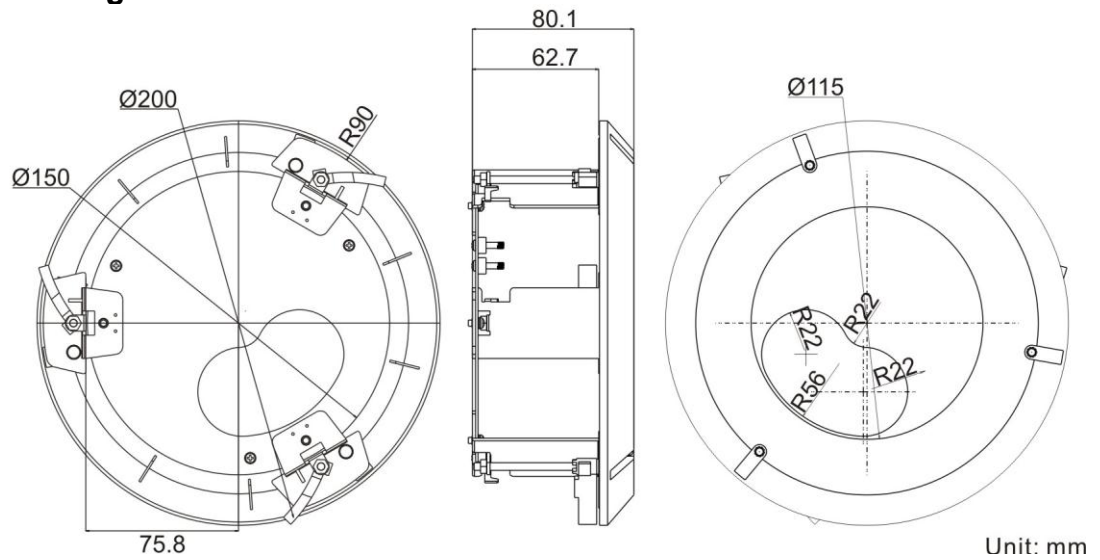


Trim Ring



Ceiling Sticker

### In-Ceiling Mount Dimension:



### Tools Needed:

- Tool for drilling
- Phillips Screw Driver
- Security Torx provided



Follow the steps below to install the In-Ceiling (T-Bar) Mounting:

**Step 1:**

Release the 2 captive Security Screws with the supplied Security Torx and open the Dome Cover.



**Figure-1:**

Captive Security Screw

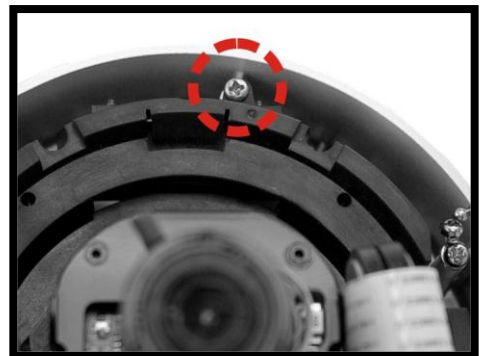


**Step 2:**

Press both sides of the Plastic Inner Cover and remove it from the Camera Module.



Unscrew the Module-fastened Screw, as indicated in the figure, with the screw driver.





**Step 3:**

Press the sides of the Snap-on Camera Module and detach it from the Dome Camera's Housing/ Plate.



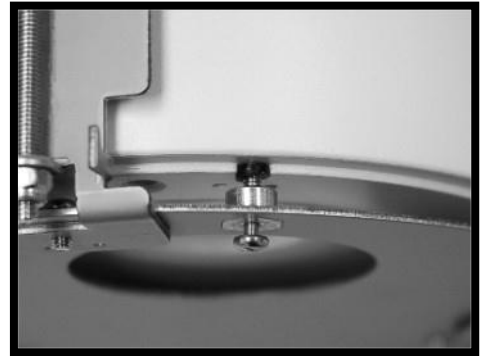
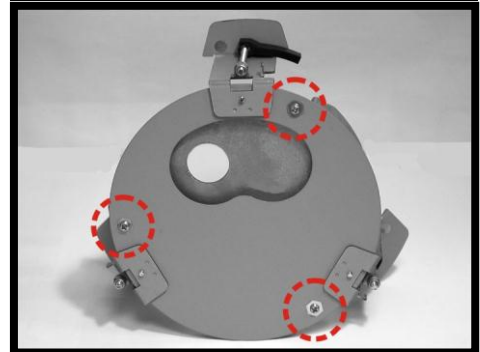
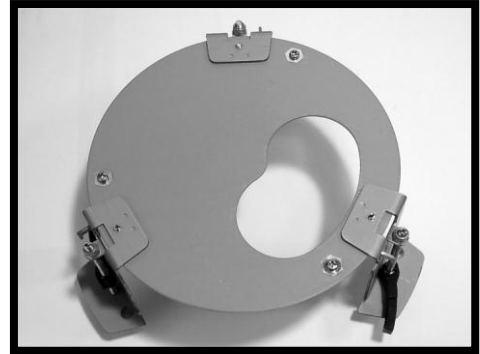
**Note:** Users may use a coin to screw off the conduit entry block for Vandal Proof IP Dome Camera.



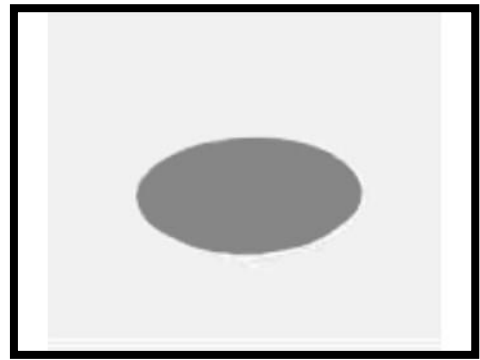
**Step 4:**

Attach the Camera Housing/ Plate's base to the In-Ceiling Mount's top plate, aligning the camera's rear cable entry with the entry hole on the In-Ceiling Mount's top plate.

Align the three Captive Screws with the mating screw holes on the Camera Housing/ Plate's base. Then tighten the three Captive Screws as shown in the figure.

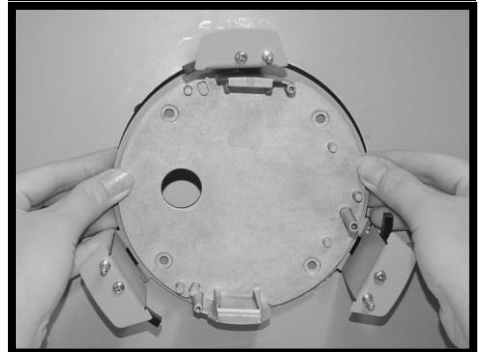
**Step 5:**

Position the supplied adhesive-backed Ceiling Sticker (Diameter: 176 mm) onto the ceiling where the Camera will be mounted, and cut the ceiling hole using the template as a guide.



**Step 6:**

Insert the Dome Camera with the attached In-Ceiling Mount into the opening and run the Ethernet cable through the desired cable entry.

**Step 7:**

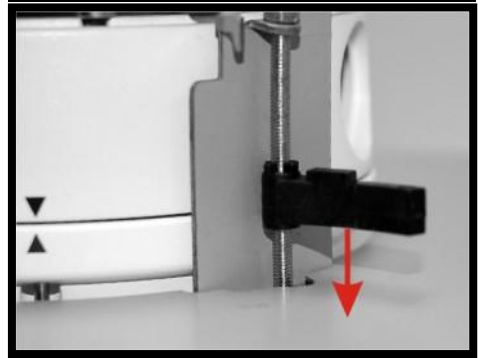
Secure the Unit to the ceiling:



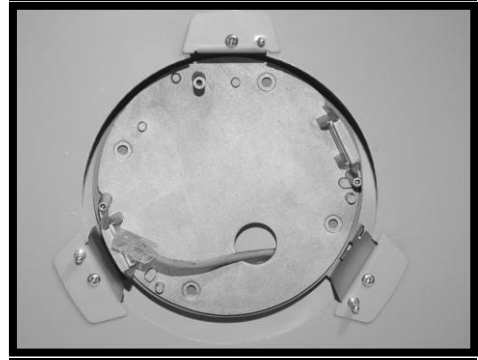
**Note:** Do Not over-tighten the three fixing screws. If using a power tool the slip clutch should be set to the lightest setting or the clamps could be damaged.



The In-Ceiling Mount's Wing Clamps will draw the Dome Camera Housing/Plate to the ceiling board until it is completely flush with the board.

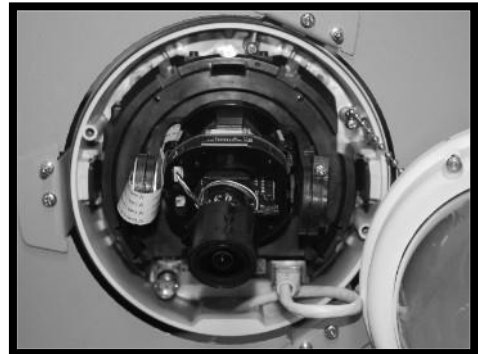


**Figure-1:**  
Bottom View of installed In-Ceiling Mount.

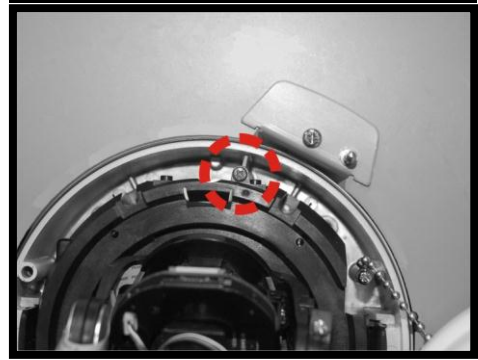


**Step 8:**  
Attach the Snap-on Camera Module to the Dome Camera Housing/ Plate.

For Vandal Proof IP Dome Camera, please install the Camera Module with the terminal blocks facing the side cable entry.



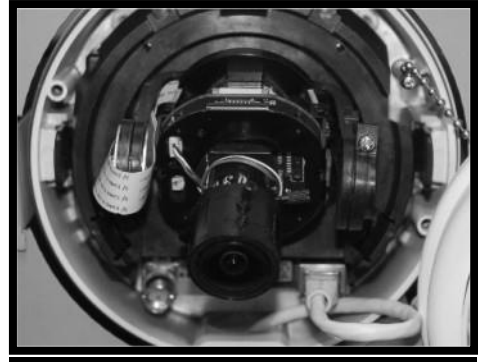
**Step 9:**  
Tighten the Module-fastening Screw.



**Step 10:**

Connect the Ethernet cable to the camera's network connector.

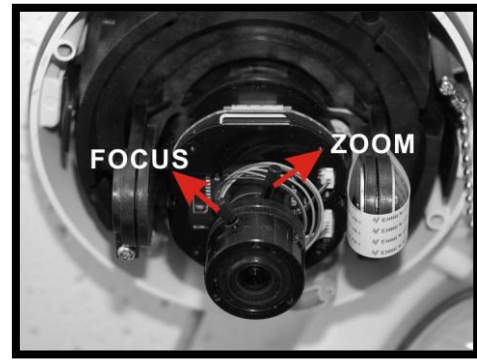
Refer to the Camera Quick Guide for details regarding the Camera Connector Definition.

**Step 11:**

Access the Camera Browser-viewer for viewing images. Please refer to Chapter [Accessing Camera](#) in IP Camera User's Manual for further details. Users can also use the Camera's BNC Connector for video output.

**Step 12:**

Adjust the Zoom Ring Screw to set the desired zoom; subsequently, modifying the Focus Ring Screw to set the desired focal length.

**Step 13:**

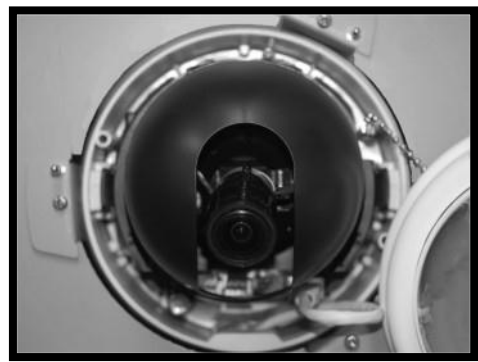
Adjust the Camera to a desired angle by adjusting Pan/Tilt/Rotation. Pan adjustment range is nearly 360°; rotation angle range approaches to 270°. Tilt is adjustable between - 10° ~ 90°.



**NOTE:** Adjust the Lens carefully within the limits mentioned above, or the cables underneath would be harmed.

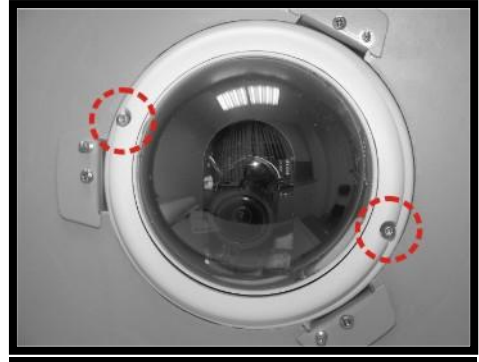
**Step 14:**

Reinstall the Plastic Inner Cover.



**Step 15:**

Close the Dome Cover and tighten the two Security Screws.

**Step 16:**

Align the 3 holes in the Trim Ring with the retaining Nut on the In-Ceiling Mount and snap the Trim Ring in place to complete the installation.



## 2. Outdoor Camera Installation

The Outdoor Vandal Proof Fixed Dome IP Camera could be mounted on the wall with the Standard/ Compact Pendant Mount for monitoring convenience.

### 2.1 Standard/Compact Pendant Mounting

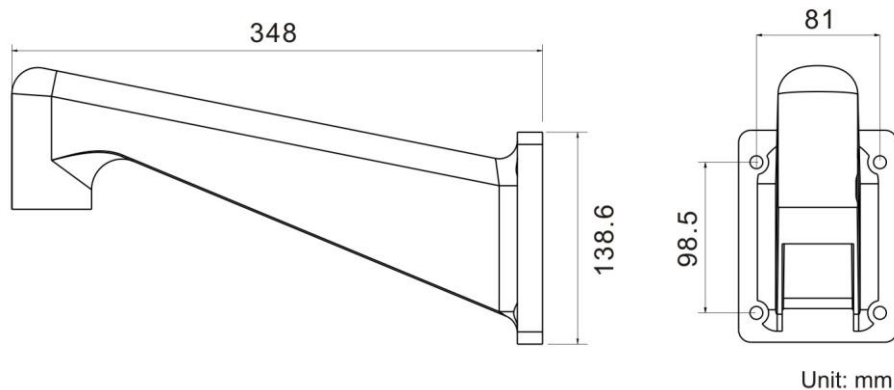
#### Standard Pendant Mount Package Contents:

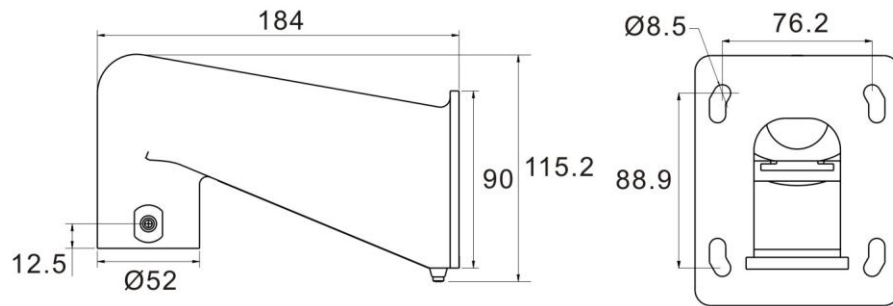
M8x16 Hex Head Stainless Steel Screw (Qty:x1)  
 Rubber Washer-8 (Qty:x1)  
 Pendant Tube Washer (Qty:x1)  
 Spring Washer-8 (Qty:x5)  
 Plain Washer-8 (Qty:x4)  
 M8x30 Hex Head Machine Screw (Qty:x4)  
 Sponge (Qty:x2)

#### Compact Pendant Mount Package Contents:

M8x16 Hex Head Stainless Steel Screw (Qty:x1)  
 Rubber Washer-8 (Qty:x1)  
 Pendant Tube Washer (Qty:x1)  
 Spring Washer-8 (Qty:x1)  
 Sponge (Qty:x1)

#### Standard Pendant Mount Dimension:



**Compact Pendant Mount Dimension:**

Unit: mm

**Tools Needed:**

Tool for drilling  
 Tool for screwing  
 Security Torx (supplied)

Follow the steps below to install the Standard/ Compact Pendant Mount:

**Step 1:**

Unscrew the Security Torx Screws with the supplied Security Torx Driver and open the Dome Cover.

**Step 2:**

Press both sides of the Inner Cover and remove it from the Camera Module.



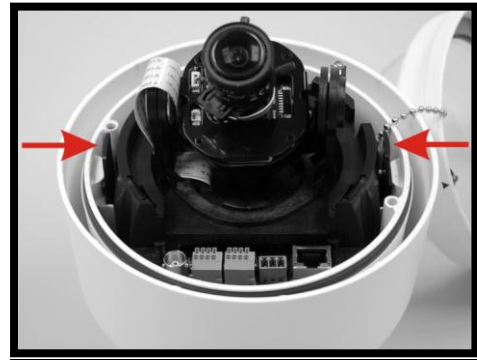


**Step 3:**

Unscrew the Module-fastened Torx Screw, as indicated in the figure.

**Step 4:**

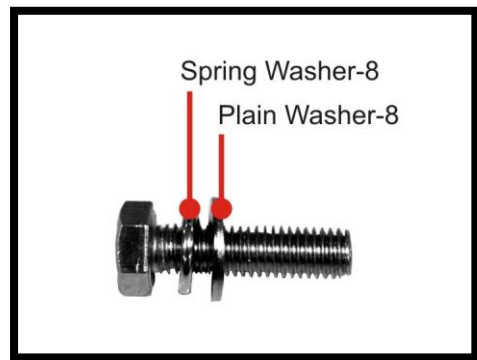
Press the sides of the Snap-on Camera Module, as indicated in the figure, and detach it from the Dome Camera's Housing.

**Step 5:**

Fasten the Standard/ Compact Pendant Mount onto the wall securely. Run the Ethernet cable through the Standard/ Compact Pendant Mount as shown in the figure.

**M8x30 Hex Head Machine Screw (for Standard Pendant Mount only):**

The Standard Pendant Mount is supplied with four M8x30 Hex Head Machine Screws for the convenience of installation by fastening the Pendant Mount with other metal part together.



**Step 6:**

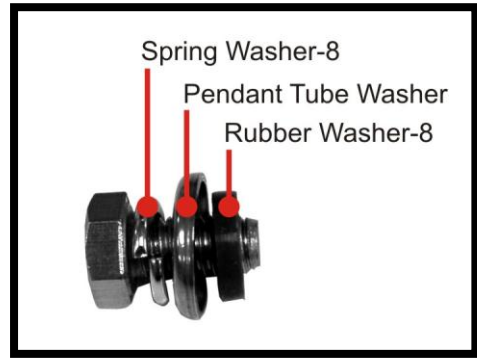
Thread the Ethernet cable through the entry of the Dome Camera's Housing.

**Step 7:**

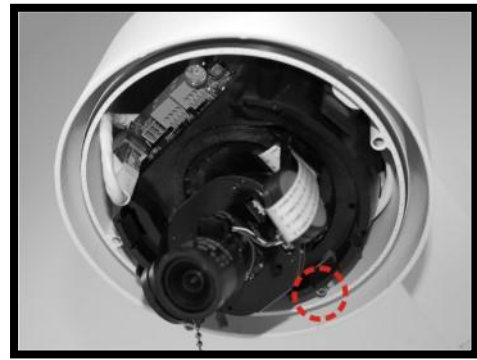
Rotate the joint of Dome Camera Housing into the entry of the Pendant Mount, aligning the screw hole of the joint with the one of the Pendant Mount.

**Step 8:**

Fix the camera housing with the supplied M8x16 Hex Head Stainless Steel Screw and Washers.

**Step 9:**

Attach the Snap-on Camera Module to the Dome Camera Housing and tighten the Module-fastened Torx Screw.

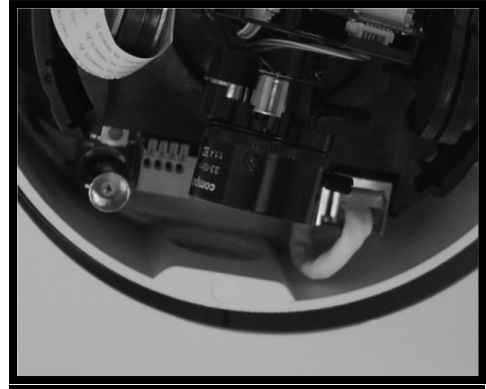


**Step 10:**

Connect the RJ-45 cable to the Camera Module to access the camera for viewing video, and then adjust the Dome Camera lens to a desired angle.



**NOTE:** The zoom level and focal length might be different with the Dome Cover on, in this case, adjusting zoom level and focal length through the Dome Cover is recommended.

**Step 11:**

Put the Inner Cover back to the Camera Module.

**Step 12:**

Close the Dome Cover and tighten the Security Torx Screws.



Installation Complete.



### 3. Cable Gland Installation

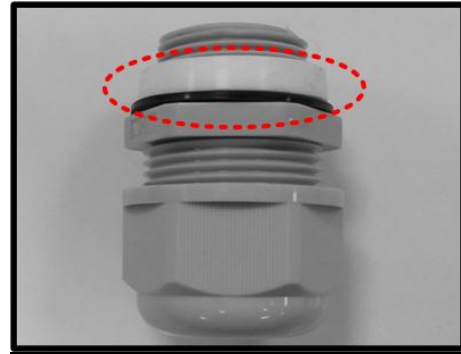
For Vandal Proof Dome-Indoor housing, cable connection can be protected from water damages by installing the all-in-one cable with a cable gland.

#### **Cable Gland Installation Kit:**

1. Silicone Rubber Ring
2. Cable Gland



First insert the silicone rubber ring into the cable gland body from the top, as shown on the right, for later use.



Before starting the installation of the all-in-one cable with the cable gland, please refer to section *Hard Ceiling installation* → Step 1~9 for camera housing installation. Then follow the instruction below.

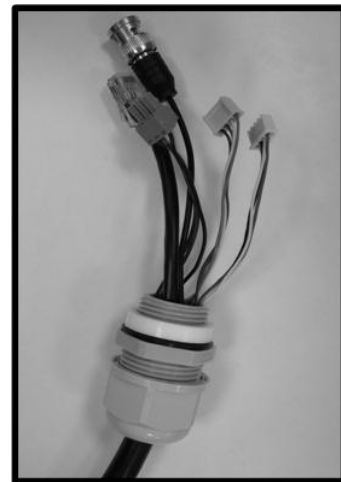
**Step 1.** Loosen the thread-lock sealing nut from the cable gland body and insert the all-in-one cable from the side with the network connector, starting from the biggest size connector to the smallest size connector.



**Step 2.** Insert the all-in-one cable to the cable gland body from the bottom, starting from the biggest size connector to the smallest size connector as well.



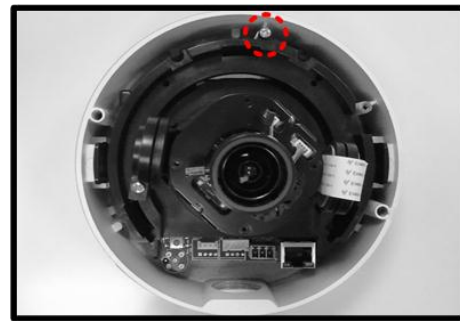
**Step 3.** Twist in the thread-lock sealing nut a little bit back to the cable gland body.



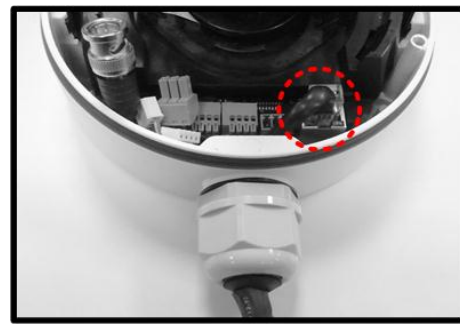
**Step 4.** Insert the all-in-one cable to the side conduit entry, again starting from the biggest size connector to the smallest size connector.



**Step 5.** Attach the Snap-on Camera Module into the Dome Camera Housing, and screw the Module-fastened Screw tightly with the screw driver to secure the Camera Module.



**Step 6.** Plug-in the connectors to their corresponding ports. Then adjust the cable lines and twist in the cable gland body to the side conduit entry. After the cable gland body is in, fasten the thread-lock sealing nut until the cable is completely covered.



After the above steps are completed, please refer to section *Hard Ceiling installation* → Step 13~18 for the remaining steps to complete the camera installation.