

**ernitec**



# **Ernitec Mercury SX Series**

**User's Manual**

## Caution and Preventive Tips

- Handle with care, do not drop the unit
- Mount the unit in an equipment rack or place it on a solid, stable surface
- Indoor use only. Do not place the unit in a humid, dusty, oily, or smoky site
- Do not place it in an area with poor ventilation or in an area close to fire or other sources of heat. Doing so may damage the unit as well as cause fire or an electric shock
- When cleaning is necessary, shut down the system and unplug the unit from the outlet before uncovering the top cover. Do not use liquid cleaners or aerosol cleaners. Use only a damp cloth for cleaning
- Always shut down the system prior connecting or disconnecting accessories, with the exception of USB devices

CE FC

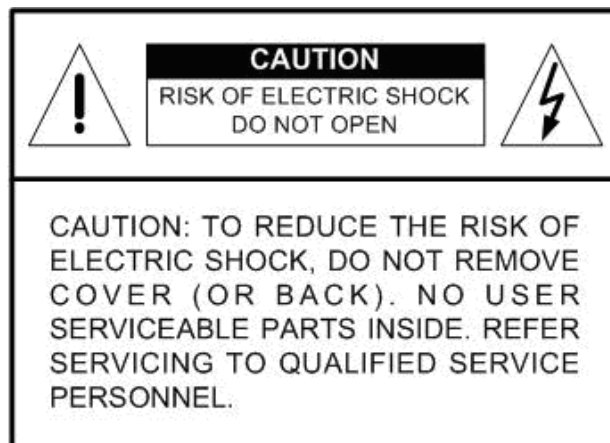

This symbol intends to alert the user to the presence of important operating and maintenance (servicing) instructions in the literature accompanying the appliance.



This symbol intends to alert the user to the presence of unprotected “Dangerous Voltage” within the product’s enclosure that may be strong enough to cause a risk of electric shock.

## **Important Information**

Before proceeding, please read and observe all instructions and warnings in this manual. Retain this manual with the original bill of sale for future reference and, if necessary, warranty service. When unpacking your unit, check for missing or damaged items. If any item is missing, or if damage is evident, **DO NOT INSTALL OR OPERATE THIS PRODUCT**. Contact your dealer for assistance.

# Table of Contents

- 1. Overview ..... 4**
  - 1.1 Features ..... 4
  - 1.2 Package Contents ..... 5
  - 1.3 Dimensions ..... 6
  - 1.4 Connectors ..... 7
- 2. Camera Cabling ..... 8**
  - 2.1 Connect Power ..... 8
  - 2.2 Connect Ethernet Cable ..... 8
  - 2.3 Connect Alarm I/O ..... 8
- 3. System Requirements ..... 9**
- 4. Access Camera ..... 10**
- 5. Setup Video Resolution ..... 14**
- 6. Configuration Files Export/ Import ..... 15**
- Appendix A: Technical Specifications ..... 16**
- Appendix B: Delete the Existing DC Viewer ..... 20**
- Appendix C: Setup Internet Security ..... 21**
- Appendix D: Video Resolution ..... 22**
  - 2M- Quad Streams ..... 22
  - 2M- Triple Streams ..... 26
  - 2M- Dual Streams ..... 28
  - 2M- Single Stream ..... 28
  - 2M Real time / 3M / 5M- Quad Streams ..... 29
  - 2M Real time / 3M / 5M- Triple Streams ..... 34
  - 2M Real time / 3M / 5M- Dual Streams ..... 37
  - 2M Real time / 3M / 5M- Single Stream ..... 38

# 1. Overview

The IP Camera features decent low light performance, high resolution up to 5 Megapixel, various video resolution combination, multiple video compression formats, etc. It also supports true day / night and 3DNR function, which display clear images in low light conditions. Moreover, the proprietary SPQ (Smart Picture Quality) function allows delivering quality images especially under intensive motion and low light conditions. With the built-in IR LED module, it makes visibility in nearly total darkness.

With H.264 High / Main / Baseline profile and MJPEG video compression formats support, it is beneficial for optimization of bandwidth and network resources. Video quad-stream support allows various surveillance applications and facilitates working with other back-end devices.

## 1.1 Features







- Progressive Scan CMOS Sensor
- Quad Streams Compression: H.264 Baseline/ Main/ High Profile + MJPEG
- Multi-language Support
- Tampering Alarm
- Remote Zoom & Focus (Motorized Lens)\*
- Wide Dynamic Range
- Motion Detection
- Privacy Masks
- Smart Picture Quality/ 3D Noise Reduction
- Vertical View Mode (Image rotation by 90 degrees)
- Smart IR Mode
- Network Failure Detection
- Day/Night (ICR)
- IR LED Module (working distance up to 25m)\*
- Micro SD support
- BNC analog output
- Weatherproof (IP66 International)
- Sunshield & Pendent Mount Housing\*
- ONVIF Support

(\*) Optional

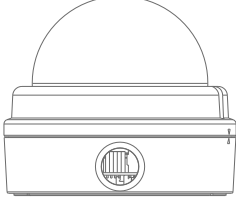
## 1.2 Package Contents

Please check the package contains the following items listed below.

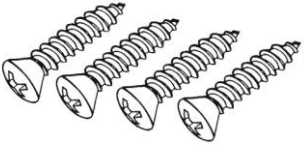
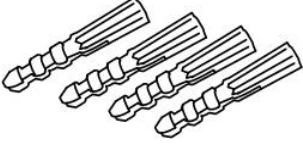
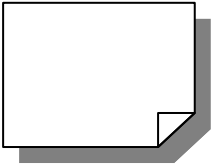
### Indoor Camera Package Contents

 <p>Vandal Proof Fixed Dome IP Camera</p>	 <p>DC Jack Cable &amp; Power Terminal Block</p>
 <p>Rubber Washers (x6)</p>	 <p>Security Torx</p>
 <p>Self Tapping Screws (x4)</p>	 <p>Plastic Screw Anchors (x4)</p>
 <p>Quick Guide</p>	 <p>CD (bundled software and documentation)</p>

## 1.3 Dimensions

The IP Dome Camera's dimensions are shown below.

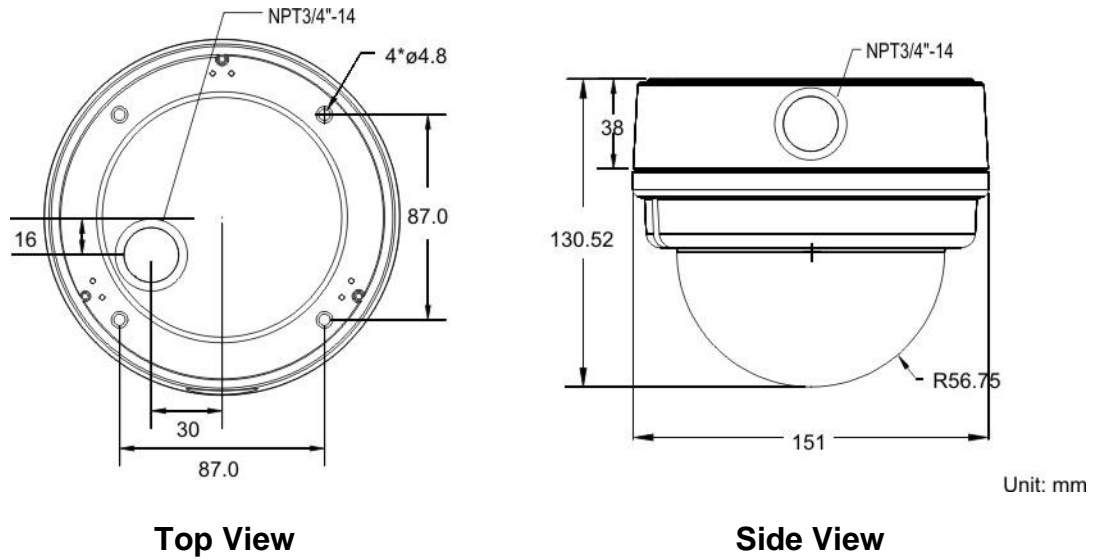

## 1.4 Connectors

The diagram below shows the IP Camera's reset button and various connectors. Definition for each connector will be given as follows.

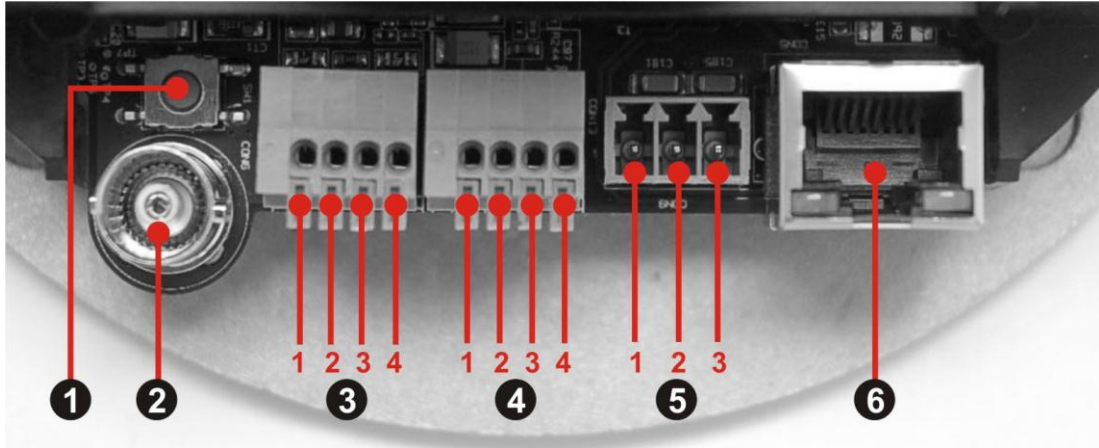

No.	Connector	Pin	Definition	Remarks	
1	Reset Button	-	Restore to factory default		
2	BNC	-	Analog Video Output		
3	Alarm I/O	1	GND (Input-)	Alarm connection	
		2	Input+		
		3	Output-		
		4	Output+		
4	Audio I/O	1	Output (L)	Two-way audio transmission	
		2	Output (R)		
		3	GND		
		4	Input		
5	Power	DC 12V	1	Power	Power connection
			2	Reserved	
			3	GND	
	AC 24V	1	Power-1		
		2	Earth GND		
		3	Power-2		
6	RJ-45	-	10/100 Mbps Ethernet / PoE		



## 2. Camera Cabling

Please follow the instructions below to complete IP Camera connection.

### 2.1 Connect Power

Please refer to [Section: Connectors](#). Alternatively, connect the Ethernet cable to the camera's PoE port and plug the other end of the cable into a PoE switch.



**NOTE:** If using PoE, make sure Power Sourcing Equipment (PSE) is in use in the network.

### 2.2 Connect Ethernet Cable

Use of Category 5 Ethernet cable is recommended for network connection; to have best transmission quality, cable length shall not exceed 100 meters. Connect one end of the Ethernet cable to the RJ-45 connector of the IP Dome Camera, and the other end of the cable to the network switch or PC.



**NOTE:** In some cases, you may need use an Ethernet crossover cable when connecting the IP Dome Camera directly to the PC.

Check the status of the link indicator and activity indicator LEDs; if the LEDs are unlit, please check LAN connection.

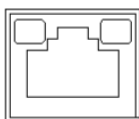

Green Link Light indicates good network connection.

Orange Activity Light flashes for network activity indication.

### 2.3 Connect Alarm I/O

The camera equips one alarm input and one relay output for alarm application. Refer to alarm pin definition below to connect alarm devices to the IP Camera if needed.

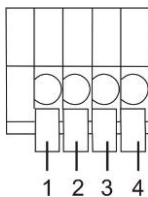

PIN 1: GND (Input-)

PIN 2: Input+

PIN 3: Output-

PIN 4: Output+

### 3. System Requirements

To perform the IP Camera via web browser, please ensure your PC is in good network connection, and meet system requirements as described below.

Items	System Requirement
<b>Personal Computer</b>	1. Intel® Pentium® M, 2.16 GHz or Intel® Core™2 Duo, 2.0 GHz 2. 2 GB RAM or more
<b>Operating System</b>	Windows VISTA / Windows XP / Windows 7
<b>Web Browser</b>	Microsoft Internet Explorer 6.0 or later Firefox Chrome Safari
<b>Network Card</b>	10Base-T (10 Mbps) or 100Base-TX (100 Mbps) operation
<b>Viewer</b>	ActiveX control plug-in for Microsoft IE

## 4. Access Camera

For initial access to the IP Camera, users can search the camera through the installer program: DeviceSearch.exe, which can be found in "DeviceSearch" folder in the supplied CD.

### Device Search Software Setup

**Step 1:** Double click on the program Device Search.exe. After its window appears, click on the <Device Search> button on the top side.

**Step 2:** The security alert window will pop up. Click on <Unblock> to continue.

### Device Search

**Step 3:** Click on <Device Search> again, and all the finding IP devices will be listed in the page. The IP Camera's default IP address is: **192.168.0.250**.

**Step 4:** Double click or right click and select <Browse> to access the camera directly via web browser.

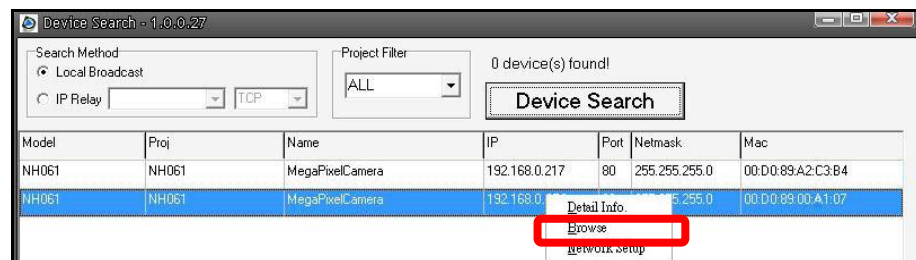

**Step 5:** Then the prompt window of request for entering default username and password will appear for login to the IP Dome Camera.

The default login ID and password for the Administrator are:

Login ID	Password
Admin	1234



**NOTE:** ID and password are case sensitive.



**NOTE:** It is strongly advised that administrator's password be altered for the security concerns. Refer to [Full HD Multiple Streams IP Camera Menu Tree](#) for further details.

Additionally, users can change the IP Camera's network property, either DHCP or Static IP directly in the device finding list. Refer to the following section for changing the IP Camera's network property.

### **Example of Changing IP Camera's Network Property**

Users can directly change an IP Camera's network property, ex. from static IP to DHCP, in the finding device list. The way to change the IP Camera's network property is specified below:

**Step 1:** In the finding device list, click on the IP Camera that you would like to change its network property. On the selected item, right click and select "Network Setup." Meanwhile, record the IP Camera's MAC address, for future identification.

**Step 2:** The "Network Setup" page will come out. Select "DHCP," and press "Apply" button down the page.

**Step 3:** Click on <OK> on the Note of setting change. Wait for one minute to re-search the IP Camera.

**Step 4:** Click on the <Device Search> button to re-search all the devices. Then select the IP Camera with the correct MAC address. Double click on the IP Camera, and the login window will come out.

**Step 5:** Enter User name and Password to access the IP Camera.

### **Installing DC Viewer Software Online**

For the initial access to the IP Camera, a client program, DC Viewer, will be automatically installed to your PC when connecting to the IP Camera.

If the Web browser doesn't allow DC Viewer installation, please check the Internet security settings or ActiveX controls and plug-ins settings (refer to [Section: Internet Security Settings](#)) to continue the process.

The Information Bar (just below the URL bar) may come out and ask for permission to install the ActiveX Control for displaying video in browser. Right click on the Information Bar and select <Install ActiveX Control...> to allow the installation.

The download procedure of DC Viewer software is specified as follows.

**Step 1:** In the DC Viewer installation window, click on <Next> to start installation.

**Step 2:** The status bar will show the installation progress. After the installation is completed, click on <Finish> to exit the installation process.

**Step 3:** Click on <Finish> to close the DC Viewer installation page.

Once the DC Viewer is successfully installed, the IP Camera's Home page will be able to correctly display as the figure below.

### Vari-focal Model

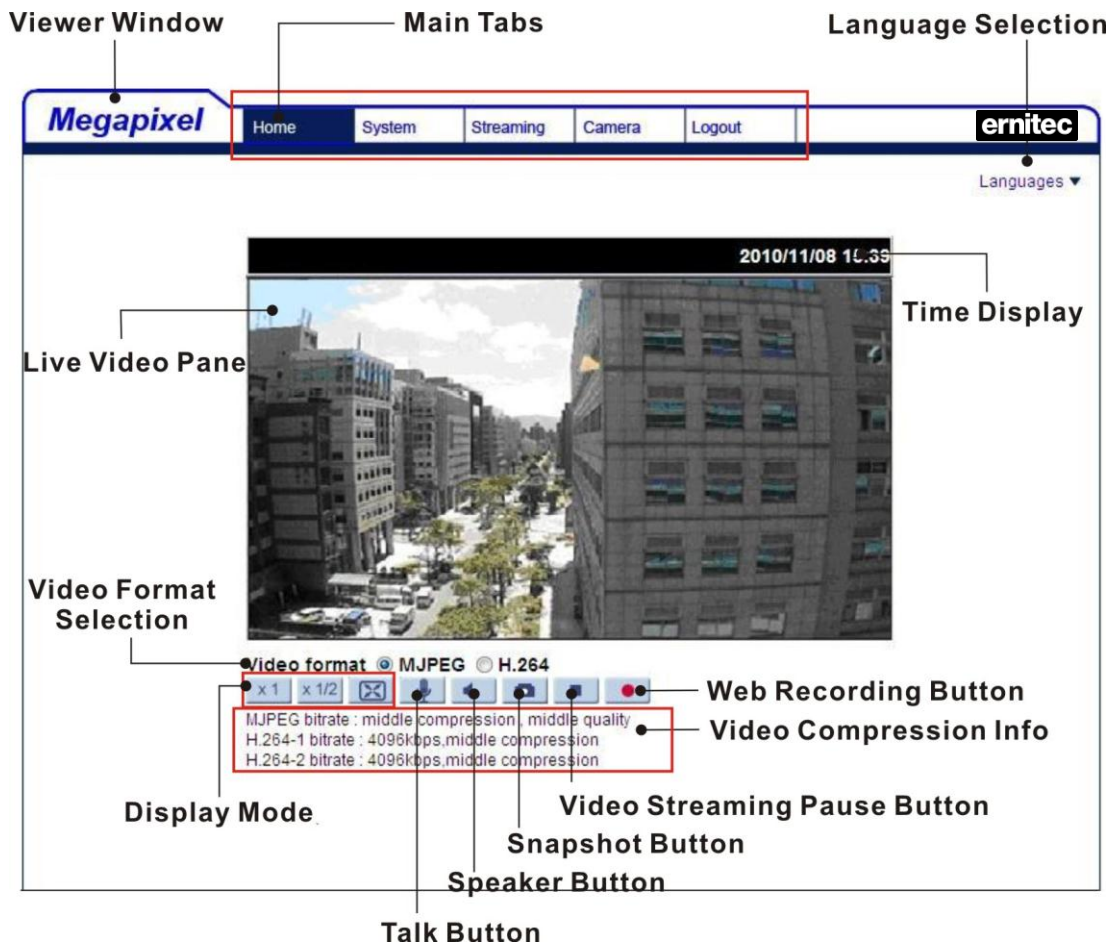

## Motorized Model

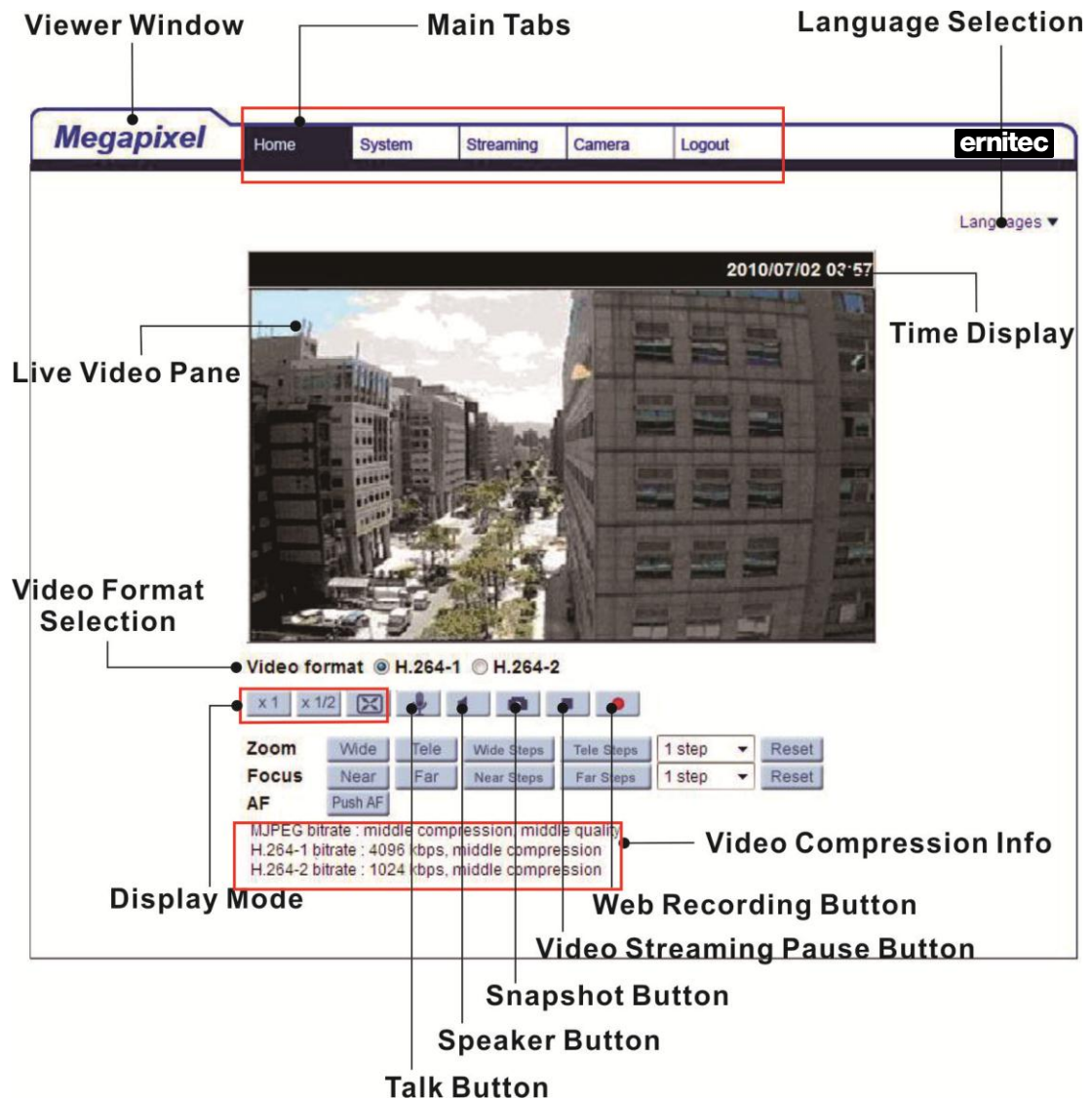

## Image and Focus Adjustment

The image displays on the Home page when successfully accessing to the IP Camera. Adjust zoom and focus as necessary to produce a clear image.



**Note:** Please refer to [Full HD Multiple Streams IP Camera Menu Tree](#) for more button function detail.

## 5. Setup Video Resolution

Users can setup Video Resolution on Video Format page of the user-friendly browser-based configuration interface.

Video Format can be found under this path: **Streaming> Video Format**.

The screenshot shows the Megapixel configuration interface. The 'Streaming' menu item is highlighted in red. The 'Video Format' page is active, showing the following settings:

- Video Resolution :** H.264 + H.264 + H.264 + H.264 (dropdown)
- H.264-1 format : 1920 x 1080 (15 fps) (dropdown)
- H.264-2 format : 1280 x 1024 (15 fps) (dropdown)
- H.264-3 format : 1280 x 720 (15 fps) (dropdown)
- H.264-4 format : 720 x 480 (15 fps) (dropdown)
- Save (button)
- Note :** Image attachment by FTP or E-mail will be available only while MJPEG streaming is selected.
- Text Overlay Settings :**
  - Include date
  - Include time
  - Include text string: [text input field]
  - Save (button)
- Video Rotate Type :** Normal video (dropdown)
- Save (button)
- GOV Settings :**
  - H.264-1 GOV Length : [60] H.264-2 GOV Length : [60]
  - H.264-3 GOV Length : [30] H.264-4 GOV Length : [30]
  - Save (button)
- H.264 Profile :**
  - H.264-1 : Main profile (dropdown) H.264-2 : Main profile (dropdown)
  - H.264-3 : Main profile (dropdown) H.264-4 : Main profile (dropdown)
  - Save (button)

The default value of Video Resolution is as below:

<b>2M</b>	H.264- 1920 x 1080 (15 fps) + H.264- 1280 x 720 (30 fps)
<b>2M Real time</b>	
<b>3M</b>	H.264- 1920 x 1080 (30 fps) + H.264 720 x 480 (30 fps)
<b>5M</b>	

For more Video Resolution combination detail, please refer to [Appendix: Video Resolution](#). Click on <Save> to confirm the setting.

## 6. Configuration Files Export/ Import

To export/ import configuration files, users can access the Maintenance page on the user-friendly browser-based configuration interface.

The Maintenance setting can be found under this path: **System> Maintenance**.

Users can export configuration files to a specified location and retrieve data by uploading an existing configuration file to the IP Camera. It is especially convenient to make multiple cameras having the same configuration.

### **Export**

Users can save the system settings by exporting the configuration file (.bin) to a specified location for future use. Click on the <Export> button, and the popup File Download window will come out. Click on <Save> and specify a desired location for saving the configuration file.

### **Upload**

To copy an existing configuration file to the IP Camera, please first click on <Browse> to select the configuration file, and then click on the <Upload> button for uploading.



## Appendix A: Technical Specifications

Camera		2M	2M Real time
Image Sensor		1/2.7" Progressive CMOS	
Effective Pixels		1920(H) x 1080(V)	
Minimum Illumination		0.2 lux (Color) 0.02 lux (B/W)	
White Balance		Manual / AWB/ ATW	
Shutter Speed		1~ 1/10000 sec.	
Lens			
Lens		Vari-focal / Motorized	Vari-focal / Motorized / 3x AF
Focal Length		3~9 mm	
F Number		Vari-focal / Motorized- F1.2 3x AF- F1.2 (Wide); F2.1 (Tele)	
FOV		Vari-focal / Motorized- 103.5° (Wide) ; 34.3° (Tele) 3x AF- 92.93° (Wide) ; 30.9° (Tele)	
Operation			
Multiple Languages		English / French / German / Italian / Korean / Simplified Chinese / Traditional Chinese / Russian	
Image Setting	Backlight Compensation	On / Off	
	White Balance	Auto / Manual	
	Noise Reduction (3D)	On / Off	
	Wide Dynamic Range	On / Off	
	Privacy Mask	On / Off	
	Brightness	Manual	
	Exposure	Auto / Manual	
	Sharpness	Manual	
	Contrast	Manual	
	Saturation	Manual	
	Hue	Manual	
	Digital Zoom	Support	
	Motion Detection	On / Off	
	Privacy Mask Type	Color	
	ICR	Auto / On / Off / Smart	
ICR + IR LED*	Auto / LED On / LED Off / Smart IR / Light Sensor		
Tampering Alarm	On / Off		
Audio	Two-way Audio	Line in, Line out	
	Compression	G.711 / G.726	
Network			
Interface		RJ-45, 10/100 Mbps Ethernet	
Video Compression		H.264 / MJPEG	
Video Streaming		Dual Streams- H.264 + H.264 / MJPEG Quad Streams- H.264 + H.264 + H.264 + H.264/ MJPEG	
Video Resolution		H.264- Full HD 1080P / SXGA / HD 720P / XGA / SVGA / D1 / VGA / CIF MJPEG- Full HD 1080P / SXGA / HD 720P / XGA / SVGA / D1 / VGA / CIF	
Protocol		IPv4/v6, TCP/IP, UDP, RTP, RTSP, HTTP, HTTPS, ICMP, FTP, SMTP, DHCP, PPPoE, UPnP, IGMP, SNMP, QoS, ONVIF	
Security		HTTPS / IP Filter / IEEE 802.1x	
Alarm	Input	1 Set 5V 10kΩ pull up	
	Output	1 Set Photo Relay Output 300V DC/AC	
Event Notification		HTTP / FTP / SMTP	
Micro SD		microSDHC 32GB support	
Supported Web Browser		Internet Explorer (6.0+) / Chrome / Firefox / Safari	
User Account		20	
Password Levels		User and Administrator	

<b>Mechanical</b>		
Built-in IR Illuminator*	Working distance	up to 25 m
	Wavelength	850 nm
	Number of LEDs	24
LED Indicator		Power / Link / ACT
Connectors	Alarm	4 Pin Terminal Block
	Power	3 Pin Terminal Block
	Ethernet	RJ-45
	Analog Video	1.0 Vp-p / 75 Ω, BNC
	Audio	Line in, Line out
<b>General</b>		
Operating Temperature	-10°C ~ 50°C (14°F ~ 122°F) w/ Heater & Fan, Powered by DC 12V: -30°C ~ 50°C (-22°F ~ 122°F) / w/ Heater & Fan, Powered by AC 24V: -35°C ~ 50°C (-31°F ~ 122°F)	
Humidity	10% ~ 90%, No Condensation	
Wheatherproof Standard	IP66	
Dimension	Indoor: ø 151 x 130 mm (ø 5.9 x 5.1 in.) Outdoor: ø 170 x 210 mm (ø 6.7 x 8.3 in.)	
Weight	Indoor: 800 g (1.8 lb) Outdoor: 1300 g (2.9 lb)	
Power Source	DC 12V / AC 24V / PoE	
Power Consumption	System: 5 W (Heater: +6 W, Fan: +1 W, Built-in IR Illuminator: +3 W, Motorized Lens: +3.6 W)	
Regulatory	CE / FCC / RoHS	

(\*) Optional

Camera		3M	5M
Image Sensor		1/2.7" Progressive CMOS	
Effective Pixels		2048(H) x 1536(V)	2592(H) x 1944(V)
Minimum Illumination		0.2 lux (Color) 0.02 lux (B/W)	TBD
White Balance		Manual / AWB/ ATW	
Shutter Speed		1~ 1/10000 sec.	
Lens			
Lens		Vari-focal / Motorized	Vari-focal / Motorized
Focal Length		3~9 mm	3.6 ~ 9 mm
F Number		F1.2	F1.8
FOV		103.5° (Wide) ; 34.3° (Tele)	100° (Wide) ~ 40° (Tele)
Operation			
Multiple Languages		English / French / German / Italian / Korean / Simplified Chinese / Traditional Chinese / Russian	
Image Setting	Backlight Compensation	On / Off	
	White Balance	Auto / Manual	
	Noise Reduction (3D)	On / Off	
	Wide Dynamic Range	On / Off	
	Privacy Mask	On / Off	
	Brightness	Manual	
	Exposure	Auto / Manual	
	Sharpness	Manual	
	Contrast	Manual	
	Saturation	Manual	
	Hue	Manual	
	Digital Zoom	Support	
	Motion Detection	On / Off	
	Privacy Mask Type	Color	
	ICR	Auto / On / Off / Smart	
ICR + IR LED*	Auto / LED On / LED Off / Smart IR / Light Sensor		
Tampering Alarm	On / Off		
Audio	Two-way Audio	Line in, Line out	
	Compression	G.711/G.726	
Network			
Interface		RJ-45, 10/100 Mbps Ethernet	
Video Compression		H.264 / MJPEG	
Video Streaming	Single Stream- 2048 x 1536		Single Stream- 2592 x 1944 / 2048 x 1536
	Dual Streams- H.264 + H.264 / MJPEG Quad Streams- H.264 + H.264 + H.264 + H.264 / MJPEG		
Video Resolution	H.264- 2048 x 1536 (3M)		H.264- 2592 x 1944 (5M) / 2048 x 1536 (3M)
	H.264- Full HD 1080P / SXGA / HD 720P / XGA / SVGA / D1 / VGA / CIF MJPEG- Full HD 1080P / SXGA / HD 720P / XGA / SVGA / D1 / VGA / CIF		
'Protocol		IPv4/v6, TCP/IP, UDP, RTP, RTSP, HTTP, HTTPS, ICMP, FTP, SMTP, DHCP, PPPoE, UPnP, IGMP, SNMP, QoS, ONVIF	
Security		HTTPS / IP Filter / IEEE 802.1x	
Alarm	Input	1 Set 5V 10kΩ pull up	
	Output	1 Set Photo Relay Output 300V DC/AC	
Event Notification		HTTP / FTP / SMTP	
Micro SD		microSDHC 32GB support	
Supported Web Browser		Internet Explorer (6.0+) / Chrome / Firefox / Safari	
User Account		20	
Password Levels		User and Administrator	

<b>Mechanical</b>		
Built-in IR Illuminator*	Working distance	up to 25 m
	Wavelength	850 nm
	Number of LEDs	24
LED Indicator		Power / Link / ACT
Connectors	Alarm	4 Pin Terminal Block
	Power	3 Pin Terminal Block
	Ethernet	RJ-45
	Analog Video	1.0 Vp-p / 75 Ω, BNC
	Audio	Line in, Line out
<b>General</b>		
Operating Temperature	-10°C ~ 50°C (14°F ~ 122°F) w/ Heater & Fan, Powered by DC 12V: -30°C ~ 50°C (-22°F ~ 122°F) / w/ Heater & Fan, Powered by AC 24V: -35°C ~ 50°C (-31°F ~ 122°F)	
Humidity	10% ~ 90%, No Condensation	
Weatherproof Standard	IP66	
Dimension	Indoor: ø 151 x 130 mm (ø 5.9 x 5.1 in.) Outdoor: ø 170 x 210 mm (ø 6.7 x 8.3 in.)	
Weight	Indoor: 800 g (1.8 lb) Outdoor: 1300 g (2.9 lb)	
Power Source	DC 12V / AC 24V / PoE	
Power Consumption	System: 5 W (Heater: +6 W, Fan: +1 W, Built-in IR Illuminator: +3 W, Motorized Lens: +3.6 W)	
Regulatory	CE / FCC / RoHS	

(\*) Optional

## Appendix B: Delete the Existing DC Viewer

For users who have installed the DC Viewer in the PC previously, please first remove the existing DC Viewer from the PC before accessing to the IP Camera.

### **Deleting the DC Viewer**

In the Windows <Start Menu>, activate <Control Panel>, and then double click on <Add or Remove Programs>. In the <Currently installed programs> list, select <DCViewer> and click on the button <Remove> to uninstall the existing DC Viewer.

### **Deleting Temporary Internet Files**

To improve browser performance, it is suggested to clean up the all the files in the Temporary Internet Files.

The procedure is as follows:

**Step 1:** Click on the <Tools> tab on the menu bar and select <Internet Options>.

**Step 2:** Click on the <Delete> button under <Browsing history> section. Then click on the <Delete Files> button under the <Temporary Internet files> section.

**Step 3:** A confirmation window will pop up. Click on <Yes> to start deleting the files.

## Appendix C: Setup Internet Security

If ActiveX control installation is blocked, please either set Internet security level to default or change ActiveX controls and plug-ins settings.

### **Internet Security Level: Default**

**Step 1:** Start the Internet Explorer (IE).

**Step 2:** Click on the <Tools> tab on the menu bar and select <Internet Options>.

**Step 3:** Click on the <Security> tab, and select <Internet> zone.

**Step 4:** Down the page, click on the <Default Level> button and click on <OK> to confirm the setting. Close the browser window, and restart a new one later to access the IP Camera.

### **ActiveX Controls and Plug-ins Settings**

**Step 1:** Repeat **Steps 1~3** of the previous section above.

**Step 2:** Down the page, click on the <Custom Level> button to change ActiveX controls and plug-ins settings. The Security Settings window will pop up.

**Step 3:** Under <ActiveX controls and plug-ins>, set **ALL** items (as listed below) to <Enable> or <Prompt>. Please note that the items vary by IE version.

#### **ActiveX controls and plug-ins settings:**

1. Allow previously unused ActiveX controls to run without prompt.
2. Allow Scriptlets.
3. Automatic prompting for ActiveX controls.
4. Binary and script behaviors.
5. Display video and animation on a webpage that does not use external media player.
6. Download signed ActiveX controls.
7. Download unsigned ActiveX controls.
8. Initialize and script ActiveX controls not marked as safe for scripting.
9. Run ActiveX controls and plug-ins.
10. Script ActiveX controls marked safe for scripting.

**Step 4:** Click on <OK> to accept the settings and close the Security Settings window.

**Step 5:** Click on <OK> to close the Internet Options screen.

**Step 6:** Close the browser window, and restart a new one later to access the IP Camera.

# Appendix D: Video Resolution

## 2M- Quad Streams

H.264 + H.264 + H.264 + H.264 / MJPEG					
H.264-1	H.264-2	H.264-3	H.264-4 / MJPEG		
1920 x 1080 (15 fps)	1280 x 1024 (15 fps)	720 x 480 (15 fps)	352 x 240 (30 fps)		
		640 x 480 (15 fps)	352 x 240 (30 fps)		
		352 x 240 (30 fps)	352 x 240 (30 fps)		
	1280 x 720 (15 fps)	800 x 600 (15 fps)	720 x 480 (15 fps)	720 x 480 (15 fps)	
				640 x 480 (15 fps)	
				352 x 240 (30 fps)	
		720 x 480 (15 fps)		720 x 480 (15 fps)	640 x 480 (15 fps)
				720 x 480 (30 fps)	352 x 240 (30 fps)
				640 x 480 (15 fps)	640 x 480 (30 fps)
				640 x 480 (30 fps)	352 x 240 (30 fps)
				352 x 240 (30 fps)	352 x 240 (30 fps)
	1024 x 768 (15 fps)	800 x 600 (15 fps)		720 x 480 (15 fps)	
				640 x 480 (15 fps)	
				352 x 240 (30 fps)	
		720 x 480 (15 fps)		720 x 480 (30 fps)	640 x 480 (30 fps)
				720 x 480 (30 fps)	352 x 240 (30 fps)
				640 x 480 (15 fps)	640 x 480 (30 fps)
				640 x 480 (30 fps)	352 x 240 (30 fps)
	800 x 600 (15 fps)	800 x 600 (15 fps)		352 x 240 (30 fps)	
				720 x 480 (30 fps)	
				640 x 480 (30 fps)	
		800 x 600 (30 fps)		800 x 600 (30 fps)	352 x 240 (30 fps)
				720 x 480 (15 fps)	720 x 480 (30 fps)
	800 x 600 (30 fps)		720 x 480 (30 fps)	640 x 480 (30 fps)	
			640 x 480 (30 fps)	640 x 480 (30 fps)	
			352 x 240 (30 fps)	352 x 240 (30 fps)	
	720 x 480 (15 fps)	720 x 480 (15 fps)		720 x 480 (30 fps)	
				640 x 480 (30 fps)	
			720 x 480 (30 fps)	640 x 480 (30 fps)	
	720 x 480 (30 fps)	720 x 480 (30 fps)		352 x 240 (30 fps)	
			352 x 240 (30 fps)		
		352 x 240 (30 fps)	352 x 240 (30 fps)		
640 x 480 (30 fps)	640 x 480 (30 fps)		640 x 480 (30 fps)		
			352 x 240 (30 fps)		
		352 x 240 (30 fps)	352 x 240 (30 fps)		
352 x 240 (30 fps)		352 x 240 (30 fps)	352 x 240 (30 fps)		

H.264 + H.264 + H.264 + H.264 / MJPEG				
H.264-1	H.264-2	H.264-3	H.264-4 / MJPEG	
1280 x 1024 (15 fps)	1280 x 1024 (15 fps)	1280 x 720 (15 fps)	720 x 480 (30 fps)	
			640 x 480 (30 fps)	
			352 x 240 (30 fps)	
		800 x 600 (15 fps)	720 x 480 (30 fps)	720 x 480 (30 fps)
				640 x 480 (30 fps)
			800 x 600 (30 fps)	352 x 240 (30 fps)
				720 x 480 (30 fps)
	720 x 480 (15 fps)		720 x 480 (30 fps)	
			640 x 480 (30 fps)	
	720 x 480 (30 fps)	640 x 480 (30 fps)		
		352 x 240 (30 fps)		
	640 x 480 (30 fps)	640 x 480 (30 fps)		
		352 x 240 (30 fps)		
	352 x 240 (30 fps)	352 x 240 (30 fps)		
	1280 x 1024 (30 fps)	1280 x 720 (15 fps)	1280 x 720 (15 fps)	720 x 480 (30 fps)
				640 x 480 (30 fps)
				352 x 240 (30 fps)
			800 x 600 (30 fps)	720 x 480 (30 fps)
		640 x 480 (30 fps)		
		352 x 240 (30 fps)		
		720 x 480 (30 fps)	720 x 480 (30 fps)	
			640 x 480 (30 fps)	
			352 x 240 (30 fps)	
		640 x 480 (30 fps)	640 x 480 (30 fps)	
			352 x 240 (30 fps)	
		1280 x 720 (30 fps)	352 x 240 (30 fps)	352 x 240 (30 fps)
		1024 x 768 (15 fps)	800 x 600 (30 fps)	720 x 480 (30 fps)
				640 x 480 (30 fps)
				352 x 240 (30 fps)
	720 x 480 (30 fps)		720 x 480 (30 fps)	
		640 x 480 (30 fps)		
	640 x 480 (30 fps)	640 x 480 (30 fps)		
640 x 480 (30 fps)				
352 x 240 (30 fps)				
1024 x 768 (30 fps)	720 x 480 (30 fps)	352 x 240 (30 fps)		
	640 x 480 (30 fps)	352 x 240 (30 fps)		
	352 x 240 (30 fps)	352 x 240 (30 fps)		
800 x 600 (15 fps)	800 x 600 (30 fps)	720 x 480 (30 fps)		
800 x 600 (30 fps)	800 x 600 (30 fps)	640 x 480 (30 fps)		
		352 x 240 (30 fps)		
	720 x 480 (30 fps)	720 x 480 (30 fps)		
		640 x 480 (30 fps)		
	640 x 480 (30 fps)	352 x 240 (30 fps)		
		640 x 480 (30 fps)		
720 x 480 (30 fps)	720 x 480 (30 fps)	720 x 480 (30 fps)		
		640 x 480 (30 fps)		
		352 x 240 (30 fps)		
	640 x 480 (30 fps)	640 x 480 (30 fps)		
		352 x 240 (30 fps)		
640 x 480 (30 fps)	640 x 480 (30 fps)	640 x 480 (30 fps)		
1280 x 1024 (30 fps)	800 x 600 (30 fps)	352 x 240 (30 fps)	352 x 240 (30 fps)	
	720 x 480 (30 fps)	352 x 240 (30 fps)	352 x 240 (30 fps)	
	640 x 480 (30 fps)	352 x 240 (30 fps)	352 x 240 (30 fps)	
	352 x 240 (30 fps)	352 x 240 (30 fps)	352 x 240 (30 fps)	



H.264 + H.264 + H.264 + H.264 / MJPEG					
H.264-1	H.264-2	H.264-3	H.264-4 / MJPEG		
1280 x 720 (15 fps)	1280 x 720 (15 fps)	1280 x 720 (15 fps)	720 x 480 (30 fps) 640 x 480 (30 fps)		
		1280 x 720 (30 fps)	352 x 240 (30 fps)		
		800 x 600 (30 fps)	720 x 480 (30 fps) 640 x 480 (30 fps)		
		720 x 480 (30 fps)	720 x 480 (30 fps) 640 x 480 (30 fps)		
		640 x 480 (30 fps)	640 x 480 (30 fps)		
	1280 x 720 (30 fps)	1280 x 720 (30 fps)	800 x 600 (30 fps)	352 x 240 (30 fps)	
			720 x 480 (30 fps)	352 x 240 (30 fps)	
			640 x 480 (30 fps)	352 x 240 (30 fps)	
			352 x 240 (30 fps)	352 x 240 (30 fps)	
	1024 x 768 (15 fps)	1024 x 768 (15 fps)	800 x 600 (30 fps)	720 x 480 (30 fps) 640 x 480 (30 fps)	
	1024 x 768 (30 fps)	1024 x 768 (30 fps)	800 x 600 (30 fps)	352 x 240 (30 fps)	
			720 x 480 (30 fps)	720 x 480 (30 fps) 640 x 480 (30 fps) 352 x 240 (30 fps)	
			640 x 480 (30 fps)	640 x 480 (30 fps) 352 x 240 (30 fps)	
		800 x 600 (30 fps)	800 x 600 (30 fps)	800 x 600 (30 fps)	720 x 480 (30 fps) 640 x 480 (30 fps) 352 x 240 (30 fps)
				720 x 480 (30 fps)	720 x 480 (30 fps) 640 x 480 (30 fps)
				640 x 480 (30 fps)	640 x 480 (30 fps)
	1280 x 720 (30 fps)	1024 x 768 (30 fps)	352 x 240 (30 fps)	352 x 240 (30 fps)	
		800 x 600 (30 fps)	800 x 600 (30 fps)	720 x 480 (30 fps)	720 x 480 (30 fps) 640 x 480 (30 fps) 352 x 240 (30 fps)
				640 x 480 (30 fps)	640 x 480 (30 fps) 352 x 240 (30 fps)
352 x 240 (30 fps)				352 x 240 (30 fps)	
720 x 480 (30 fps)		720 x 480 (30 fps)	640 x 480 (30 fps)	640 x 480 (30 fps) 352 x 240 (30 fps)	
			352 x 240 (30 fps)	352 x 240 (30 fps)	
640 x 480 (30 fps)		640 x 480 (30 fps)	640 x 480 (30 fps)	640 x 480 (30 fps) 352 x 240 (30 fps)	
			352 x 240 (30 fps)	352 x 240 (30 fps)	
352 x 240 (30 fps)		352 x 240 (30 fps)	352 x 240 (30 fps)	352 x 240 (30 fps)	
1024 x 768 (15 fps)	1024 x 768 (15 fps)	800 x 600 (30 fps)	720 x 480 (30 fps) 640 x 480 (30 fps)		
	1024 x 768 (30 fps)	800 x 600 (30 fps)	352 x 240 (30 fps)		
		720 x 480 (30 fps)	720 x 480 (30 fps) 640 x 480 (30 fps) 352 x 240 (30 fps)		
		640 x 480 (30 fps)	640 x 480 (30 fps)		
	800 x 600 (30 fps)	800 x 600 (30 fps)	800 x 600 (30 fps)	720 x 480 (30 fps) 640 x 480 (30 fps)	

H.264 + H.264 + H.264 + H.264 / MJPEG				
H.264-1	H.264-2	H.264-3	H.264-4 / MJPEG	
1024 x 768 (30 fps)	1024 x 768 (30 fps)	640 x 480 (30 fps)	352 x 240 (30 fps)	
		352 x 240 (30 fps)	352 x 240 (30 fps)	
	800 x 600 (30 fps)	800 x 600 (30 fps)	800 x 600 (30 fps)	352 x 240 (30 fps)
			720 x 480 (30 fps)	720 x 480 (30 fps)
		640 x 480 (30 fps)	640 x 480 (30 fps)	640 x 480 (30 fps)
			352 x 240 (30 fps)	352 x 240 (30 fps)
			352 x 240 (30 fps)	352 x 240 (30 fps)
	720 x 480 (30 fps)	720 x 480 (30 fps)	720 x 480 (30 fps)	720 x 480 (30 fps)
			640 x 480 (30 fps)	640 x 480 (30 fps)
		640 x 480 (30 fps)	640 x 480 (30 fps)	640 x 480 (30 fps)
			352 x 240 (30 fps)	352 x 240 (30 fps)
	640 x 480 (30 fps)	640 x 480 (30 fps)	640 x 480 (30 fps)	640 x 480 (30 fps)
			352 x 240 (30 fps)	352 x 240 (30 fps)
	352 x 240 (30 fps)	352 x 240 (30 fps)	352 x 240 (30 fps)	352 x 240 (30 fps)
352 x 240 (30 fps)			352 x 240 (30 fps)	
800 x 600 (30 fps)	800 x 600 (30 fps)	800 x 600 (30 fps)	352 x 240 (30 fps)	
		720 x 480 (30 fps)	720 x 480 (30 fps)	720 x 480 (30 fps)
			640 x 480 (30 fps)	640 x 480 (30 fps)
		640 x 480 (30 fps)	640 x 480 (30 fps)	640 x 480 (30 fps)
			352 x 240 (30 fps)	352 x 240 (30 fps)
	720 x 480 (30 fps)	720 x 480 (30 fps)	720 x 480 (30 fps)	720 x 480 (30 fps)
			640 x 480 (30 fps)	640 x 480 (30 fps)
		640 x 480 (30 fps)	640 x 480 (30 fps)	640 x 480 (30 fps)
			352 x 240 (30 fps)	352 x 240 (30 fps)
	640 x 480 (30 fps)	640 x 480 (30 fps)	640 x 480 (30 fps)	640 x 480 (30 fps)
			352 x 240 (30 fps)	352 x 240 (30 fps)
	352 x 240 (30 fps)	352 x 240 (30 fps)	352 x 240 (30 fps)	352 x 240 (30 fps)
			352 x 240 (30 fps)	352 x 240 (30 fps)
	720 x 480 (30 fps)	720 x 480 (30 fps)	720 x 480 (30 fps)	720 x 480 (30 fps)
640 x 480 (30 fps)				640 x 480 (30 fps)
640 x 480 (30 fps)			640 x 480 (30 fps)	640 x 480 (30 fps)
			352 x 240 (30 fps)	352 x 240 (30 fps)
640 x 480 (30 fps)		640 x 480 (30 fps)	640 x 480 (30 fps)	640 x 480 (30 fps)
			352 x 240 (30 fps)	352 x 240 (30 fps)
		352 x 240 (30 fps)	352 x 240 (30 fps)	352 x 240 (30 fps)
			352 x 240 (30 fps)	352 x 240 (30 fps)
640 x 480 (30 fps)	640 x 480 (30 fps)	640 x 480 (30 fps)	640 x 480 (30 fps)	
		352 x 240 (30 fps)	352 x 240 (30 fps)	
	352 x 240 (30 fps)	352 x 240 (30 fps)	352 x 240 (30 fps)	
		352 x 240 (30 fps)	352 x 240 (30 fps)	
352 x 240 (30 fps)	352 x 240 (30 fps)	352 x 240 (30 fps)	352 x 240 (30 fps)	
		352 x 240 (30 fps)	352 x 240 (30 fps)	
		352 x 240 (30 fps)	352 x 240 (30 fps)	

## 2M- Triple Streams

H.264-1 + H.264-2 + H.264-3 / MJPEG				
H.264-1	H.264-2	H.264-3 / MJPEG		
1920 x 1080 (15 fps)	1280 x 1024 (15 fps)	800 x 600 (15 fps)		
		720 x 480 (15 fps)		
		640 x 480 (15 fps)		
		352 x 240 (30 fps)		
	1280 x 720 (15 fps)	1280 x 720 (15 fps)	1280 x 720 (15 fps)	
			800 x 600 (15 fps)	
			720 x 480 (30 fps)	
			640 x 480 (30 fps)	
	1024 x 768 (15 fps)	1024 x 768 (15 fps)	352 x 240 (30 fps)	
			800 x 600 (30 fps)	
	800 x 600 (30 fps)	1024 x 768 (30 fps)	720 x 480 (30 fps)	
			640 x 480 (30 fps)	
		800 x 600 (15 fps)	800 x 600 (15 fps)	640 x 480 (30 fps)
				352 x 240 (30 fps)
720 x 480 (30 fps)		720 x 480 (30 fps)	800 x 600 (30 fps)	
			720 x 480 (30 fps)	
			640 x 480 (30 fps)	
640 x 480 (30 fps)		640 x 480 (30 fps)	352 x 240 (30 fps)	
			352 x 240 (30fps)	
1280 x 1024 (15 fps)		1280 x 1024 (15 fps)	1280 x 720 (15 fps)	
	800 x 600 (30 fps)			
	720 x 480 (30 fps)			
	640 x 480 (30 fps)			
	352 x 240 (30 fps)			
	1280 x 720 (15 fps)	1280 x 720 (15 fps)	800 x 600 (30 fps)	
			720 x 480 (30 fps)	
	1280 x 720 (30 fps)	1280 x 720 (30 fps)	640 x 480 (30 fps)	
			352 x 240 (30 fps)	
			800 x 600 (30 fps)	
	1024 x 768 (30 fps)	1024 x 768 (30 fps)	720 x 480 (30 fps)	
			640 x 480 (30 fps)	
			352 x 240 (30 fps)	
			800 x 600 (30 fps)	
800 x 600 (30 fps)	800 x 600 (30 fps)	720 x 480 (30 fps)		
		640 x 480 (30 fps)		
		720 x 480 (30 fps)		
1280 x 1024 (30 fps)	800 x 600 (30 fps)	352 x 240 (30 fps)		
		720 x 480 (30 fps)		
	720 x 480 (30 fps)	720 x 480 (30 fps)	640 x 480 (30 fps)	
			352 x 240 (30 fps)	
			640 x 480 (30 fps)	
1280 x 720 (15 fps)	1280 x 720 (15 fps)	352 x 240 (30 fps)		
		352 x 240 (30 fps)		
		1280 x 720 (30 fps)		
1280 x 720 (15 fps)	1280 x 720 (30 fps)	800 x 600 (30 fps)		
		720 x 480 (30 fps)		
	1024 x 768 (30 fps)	1024 x 768 (30 fps)	640 x 480 (30 fps)	
			800 x 600 (30 fps)	
			720 x 480 (30 fps)	
			640 x 480 (30 fps)	

H.264-1 + H.264-2 + H.264-3 / MJPEG			
H.264-1	H.264-2	H.264-3 / MJPEG	
1280 x 720 (30 fps)	1280 x 720 (30 fps)	352 x 240 (30 fps)	
	1024 x 768 (30 fps)	352 x 240 (30 fps)	
	800 x 600 (30 fps)		800 x 600 (30 fps)
			720 x 480 (30 fps)
			640 x 480 (30 fps)
			352 x 240 (30 fps)
	720 x 480 (30 fps)		720 x 480 (30 fps)
			640 x 480 (30 fps)
352 x 240 (30 fps)			
640 x 480 (30 fps)		640 x 480 (30 fps)	
352 x 240 (30 fps)		352 x 240 (30 fps)	
1024 x 768 (15 fps)	1024 x 768 (30 fps)	800 x 600 (30 fps)	
1024 x 768 (30 fps)	1024 x 768 (30 fps)	720 x 480 (30 fps)	
		640 x 480 (30 fps)	
		352 x 240 (30 fps)	
	800 x 600 (30 fps)		800 x 600 (30 fps)
			720 x 480 (30 fps)
			640 x 480 (30 fps)
			352 x 240 (30 fps)
	720 x 480 (30 fps)		720 x 480 (30 fps)
			640 x 480 (30 fps)
			352 x 240 (30 fps)
	640 x 480 (30 fps)		640 x 480 (30 fps)
			352 x 240 (30 fps)
352 x 240 (30 fps)		352 x 240 (30 fps)	
800 x 600 (30 fps)	800 x 600 (30 fps)	800 x 600 (30 fps)	
		720 x 480 (30 fps)	
		640 x 480 (30 fps)	
		352 x 240 (30 fps)	
	720 x 480 (30 fps)		720 x 480 (30 fps)
			640 x 480 (30 fps)
			352 x 240 (30 fps)
			352 x 240 (30 fps)
640 x 480 (30 fps)		640 x 480 (30 fps)	
		352 x 240 (30 fps)	
		352 x 240 (30 fps)	
		352 x 240 (30 fps)	
720 x 480 (30 fps)	720 x 480 (30 fps)	720 x 480 (30 fps)	
		640 x 480 (30 fps)	
		352 x 240 (30 fps)	
	640 x 480 (30 fps)		640 x 480 (30 fps)
			352 x 240 (30 fps)
352 x 240 (30 fps)		352 x 240 (30 fps)	
640 x 480 (30 fps)	640 x 480 (30 fps)	640 x 480 (30 fps)	
	352 x 240 (30 fps)	352 x 240 (30 fps)	
352 x 240 (30 fps)	352 x 240 (30 fps)	352 x 240 (30 fps)	

## 2M- Dual Streams

H.264-1 + H.264-2 / MJPEG		
H.264-1	H.264-2 / MJPEG	BNC SUPPORT
1920 x 1080 (15 fps)	1280 x 1024 (15 fps)	-
	1280 x 720 (30 fps)	-
	1024 x 768 (30 fps)	-
	800 x 600 (30 fps)	-
	720 x 480 (30 fps)	√
	640 x 480 (30 fps)	√
	352 x 240 (30 fps)	√
1280 x 1024 (30 fps)	1280 x 1024 (15 fps)	√
	1280 x 720 (15 fps)	-
	1024 x 768 (15 fps)	-
	800 x 600 (30 fps)	-
	720 x 480 (30 fps)	√
	640 x 480 (30 fps)	√
1280 x 720 (30 fps)	352 x 240 (30 fps)	√
	1280 x 720 (30 fps)	√
	1024 x 768 (30 fps)	-
	800 x 600 (30 fps)	-
	720 x 480 (30 fps)	√
	640 x 480 (30 fps)	√
1024 x 768 (30 fps)	352 x 240 (30 fps)	√
	640 x 480 (30 fps)	√
	720 x 480 (30 fps)	√
	800 x 600 (30 fps)	-
	1024 x 768 (30 fps)	√
800 x 600 (30 fps)	352 x 240 (30 fps)	√
	640 x 480 (30 fps)	√
	720 x 480 (30 fps)	√
	800 x 600 (30 fps)	√
720 x 480 (30 fps)	352 x 240 (30 fps)	√
	640 x 480 (30 fps)	√
	720 x 480 (30 fps)	√
640 x 480 (30 fps)	352 x 240 (30 fps)	√
	640 x 480 (30 fps)	√
352 x 240 (30 fps)	352 x 240 (30 fps)	-

## 2M- Single Stream

H.264 Only	BNC SUPPORT
1920 x 1080 (15 fps) Low Latency	-
1920 x 1080 (15 fps)	√
1280 x 1024 (30 fps)	√
1280 x 720 (30 fps)	√
1024 x 768 (30 fps)	√
800 x 600 (30 fps)	√
720 x 480 (30 fps)	√
640 x 480 (30 fps)	√
352 x 240 (30 fps)	-

MJPEG Only	BNC SUPPORT
1920 x 1080 (15 fps)	√
1280 x 1024 (30 fps)	√
1280 x 720 (30 fps)	√
1024 x 768 (30 fps)	√
800 x 600 (30 fps)	√
720 x 480 (30 fps)	√
640 x 480 (30 fps)	√
352 x 240 (30 fps)	-

## 2M Real time / 3M / 5M- Quad Streams

H.264 + H.264 + H.264 + H.264 / MJPEG				
H.264-1	H.264-2	H.264-3	H.264-4 / MJPEG	
2592 x 1944 (10 fps)	720 x 480 (10 fps)	720 x 480 (10 fps)	352 x 240 (10 fps)	
		640 x 480 (10 fps)	640 x 480 (10 fps)	
		352 x 240 (10 fps)	352 x 240 (10 fps)	
	640 x 480 (10 fps)	640 x 480 (10 fps)	640 x 480 (10 fps)	640 x 480 (10 fps)
			352 x 240 (10 fps)	352 x 240 (10 fps)
			352 x 240 (10 fps)	352 x 240 (10 fps)

\*The resolution is for 5M Model only.

H.264 + H.264 + H.264 + H.264 / MJPEG					
H.264-1	H.264-2	H.264-3	H.264-4 / MJPEG		
2048 x 1536 (15 fps)	1280 x 720 (15 fps)	720 x 480 (15 fps)	640 x 480 (15 fps)		
			352 x 240 (15 fps)		
		640 x 480 (15 fps)	640 x 480 (15 fps)		
	800 x 600 (15 fps)	800 x 600 (15 fps)	352 x 240 (15 fps)	352 x 240 (15 fps)	
			720 x 480 (15 fps)	720 x 480 (15 fps)	
				640 x 480 (15 fps)	640 x 480 (15 fps)
		352 x 240 (15 fps)		352 x 240 (15 fps)	
		720 x 480 (15 fps)	720 x 480 (15 fps)	640 x 480 (15 fps)	640 x 480 (15 fps)
					352 x 240 (15 fps)
	352 x 240 (15 fps)			352 x 240 (15 fps)	
	640 x 480 (15 fps)		640 x 480 (15 fps)	640 x 480 (15 fps)	640 x 480 (15 fps)
				352 x 240 (15 fps)	352 x 240 (15 fps)
				352 x 240 (15 fps)	352 x 240 (15 fps)

\*The resolution is for 3M & 5M Model only.

H.264 + H.264 + H.264 + H.264 / MJPEG				
H.264-1	H.264-2	H.264-3	H.264-4 / MJPEG	
1920 x 1080 (15 fps)	1280 x 1024 (15 fps)	1280 x 720 (15 fps)	720 x 480 (15 fps)	
			640 x 480 (15 fps)	
			352 x 240 (30 fps)	
		1280 x 720 (15 fps)	800 x 600 (15 fps)	720 x 480 (30 fps)
				640 x 480 (30 fps)
			800 x 600 (30 fps)	352 x 240 (30 fps)
			720 x 480 (15 fps)	720 x 480 (30 fps)
			720 x 480 (30 fps)	640 x 480 (30 fps)
	640 x 480 (30 fps)		352 x 240 (30 fps)	
	352 x 240 (30 fps)		352 x 240 (30 fps)	
	1280 x 720 (15 fps)	1280 x 720 (15 fps)	720 x 480 (30 fps)	
			640 x 480 (30 fps)	
			352 x 240 (30 fps)	
			720 x 480 (30 fps)	
	1280 x 720 (30 fps)	800 x 600 (30 fps)	640 x 480 (30 fps)	
			352 x 240 (30 fps)	
			720 x 480 (30 fps)	
	1024 x 768 (15 fps)	720 x 480 (30 fps)	640 x 480 (30 fps)	
			640 x 480 (30 fps)	
			640 x 480 (30 fps)	
	1024 x 768 (30 fps)	800 x 600 (30 fps)	352 x 240 (30 fps)	
			720 x 480 (30 fps)	
			640 x 480 (30 fps)	
			352 x 240 (30 fps)	
	800 x 600 (30 fps)	720 x 480 (30 fps)	720 x 480 (30 fps)	
			640 x 480 (30 fps)	
			352 x 240 (30 fps)	
			640 x 480 (30 fps)	
			352 x 240 (30 fps)	
	720 x 480 (30 fps)	720 x 480 (30 fps)	640 x 480 (30 fps)	
			352 x 240 (30 fps)	
			640 x 480 (30 fps)	
640 x 480 (30 fps)	640 x 480 (30 fps)	352 x 240 (30 fps)		
		352 x 240 (30 fps)		
1920 x 1080 (30 fps)	352 x 240 (30 fps)	352 x 240 (30 fps)	352 x 240 (30 fps)	

H.264-1	H.264-2	H.264-3	H.264-4 / MJPEG		
1280 x 1024 (15 fps)	1280 x 1024 (15 fps)	1280 x 720 (15 fps)	720 x 480 (30 fps)		
		1280 x 720 (30 fps)	640 x 480 (30 fps)		
		800 x 600 (30 fps)	352 x 240 (30 fps)		
			720 x 480 (30 fps)	720 x 480 (30 fps)	
			640 x 480 (30 fps)	640 x 480 (30 fps)	
		720 x 480 (30 fps)	352 x 240 (30 fps)		
	640 x 480 (30 fps)		640 x 480 (30 fps)		
	640 x 480 (30 fps)		640 x 480 (30 fps)		
	1280 x 1024 (30 fps)	720 x 480 (30 fps)	352 x 240 (30 fps)		
		640 x 480 (30 fps)	352 x 240 (30 fps)		
		352 x 240 (30 fps)	352 x 240 (30 fps)		
	1280 x 720 (15 fps)	1280 x 720 (30 fps)	720 x 480 (30 fps)	720 x 480 (30 fps)	
			640 x 480 (30 fps)	640 x 480 (30 fps)	
			352 x 240 (30 fps)	352 x 240 (30 fps)	
	1280 x 1024 (30 fps)	1280 x 720 (30 fps)	800 x 600 (30 fps)	720 x 480 (30 fps)	
			720 x 480 (30 fps)	640 x 480 (30 fps)	
				352 x 240 (30 fps)	
				640 x 480 (30 fps)	640 x 480 (30 fps)
			640 x 480 (30 fps)	352 x 240 (30 fps)	
				352 x 240 (30 fps)	
		352 x 240 (30 fps)			
		1024 x 768 (30 fps)	800 x 600 (30 fps)	720 x 480 (30 fps)	720 x 480 (30 fps)
				640 x 480 (30 fps)	640 x 480 (30 fps)
				352 x 240 (30 fps)	352 x 240 (30 fps)
720 x 480 (30 fps)			640 x 480 (30 fps)	640 x 480 (30 fps)	
			352 x 240 (30 fps)	352 x 240 (30 fps)	
	352 x 240 (30 fps)		352 x 240 (30 fps)		
800 x 600 (30 fps)	800 x 600 (30 fps)	720 x 480 (30 fps)	720 x 480 (30 fps)		
		640 x 480 (30 fps)	640 x 480 (30 fps)		
		352 x 240 (30 fps)	352 x 240 (30 fps)		
	720 x 480 (30 fps)	640 x 480 (30 fps)	640 x 480 (30 fps)		
		352 x 240 (30 fps)	352 x 240 (30 fps)		
		352 x 240 (30 fps)	352 x 240 (30 fps)		
1280 x 1024 (30 fps)	1024 x 768 (30 fps)	352 x 240 (30 fps)	352 x 240 (30 fps)		
	800 x 600 (30 fps)	800 x 600 (30 fps)	352 x 240 (30 fps)		
		720 x 480 (30 fps)	352 x 240 (30 fps)		
		640 x 480 (30 fps)	640 x 480 (30 fps)		
		352 x 240 (30 fps)	352 x 240 (30 fps)		
	720 x 480 (30 fps)	720 x 480 (30 fps)	720 x 480 (30 fps)	720 x 480 (30 fps)	
			640 x 480 (30 fps)	640 x 480 (30 fps)	
			352 x 240 (30 fps)	352 x 240 (30 fps)	
			352 x 240 (30 fps)	352 x 240 (30 fps)	
	640 x 480 (30 fps)	640 x 480 (30 fps)	640 x 480 (30 fps)	640 x 480 (30 fps)	
			352 x 240 (30 fps)	352 x 240 (30 fps)	
			352 x 240 (30 fps)	352 x 240 (30 fps)	
352 x 240 (30 fps)			352 x 240 (30 fps)		
352 x 240 (30 fps)	352 x 240 (30 fps)	352 x 240 (30 fps)	352 x 240 (30 fps)		
1280 x 720 (15 fps)	1280 x 720 (15 fps)	1280 x 720 (30 fps)	720 x 480 (30 fps)		
	1280 x 720 (30 fps)	1280 x 720 (30 fps)	640 x 480 (30 fps)		
			352 x 240 (30 fps)		
			800 x 600 (30 fps)	720 x 480 (30 fps)	
			720 x 480 (30 fps)	640 x 480 (30 fps)	
	640 x 480 (30 fps)	640 x 480 (30 fps)	640 x 480 (30 fps)	640 x 480 (30 fps)	
			352 x 240 (30 fps)	352 x 240 (30 fps)	
			352 x 240 (30 fps)	352 x 240 (30 fps)	
			352 x 240 (30 fps)	352 x 240 (30 fps)	
	1024 x 768 (30 fps)	800 x 600 (30 fps)	720 x 480 (30 fps)	640 x 480 (30 fps)	



H.264 + H.264 + H.264 + H.264 / MJPEG				
H.264-1	H.264-2	H.264-3	H.264-4 / MJPEG	
1280 x 720 (30 fps)	1280 x 720 (30 fps)	800 x 600 (30 fps)	352 x 240 (30 fps)	
		720 x 480 (30 fps)	352 x 240 (30 fps)	
		640 x 480 (30 fps)	352 x 240 (30 fps)	
		352 x 240 (30 fps)	352 x 240 (30 fps)	
	1024 x 768 (30 fps)	800 x 600 (30 fps)	800 x 600 (30 fps)	352 x 240 (30 fps)
			720 x 480 (30 fps)	720 x 480 (30 fps)
			640 x 480 (30 fps)	640 x 480 (30 fps)
		720 x 480 (30 fps)	640 x 480 (30 fps)	352 x 240 (30 fps)
			352 x 240 (30 fps)	352 x 240 (30 fps)
			352 x 240 (30 fps)	352 x 240 (30 fps)
	800 x 600 (30 fps)	800 x 600 (30 fps)	800 x 600 (30 fps)	720 x 480 (30 fps)
			720 x 480 (30 fps)	640 x 480 (30 fps)
			640 x 480 (30 fps)	352 x 240 (30 fps)
			352 x 240 (30 fps)	352 x 240 (30 fps)
		720 x 480 (30 fps)	720 x 480 (30 fps)	720 x 480 (30 fps)
			640 x 480 (30 fps)	640 x 480 (30 fps)
			640 x 480 (30 fps)	352 x 240 (30 fps)
			352 x 240 (30 fps)	352 x 240 (30 fps)
	640 x 480 (30 fps)	640 x 480 (30 fps)	640 x 480 (30 fps)	
		352 x 240 (30 fps)	352 x 240 (30 fps)	
		352 x 240 (30 fps)	352 x 240 (30 fps)	
		352 x 240 (30 fps)	352 x 240 (30 fps)	
	1024 x 768 (30 fps)	1024 x 768 (30 fps)	800 x 600 (30 fps)	720 x 480 (30 fps)
				640 x 480 (30 fps)
352 x 240 (30 fps)				
720 x 480 (30 fps)			720 x 480 (30 fps)	720 x 480 (30 fps)
			640 x 480 (30 fps)	640 x 480 (30 fps)
			640 x 480 (30 fps)	352 x 240 (30 fps)
			352 x 240 (30 fps)	352 x 240 (30 fps)
800 x 600 (30 fps)			800 x 600 (30 fps)	800 x 600 (30 fps)
		720 x 480 (30 fps)		640 x 480 (30 fps)
		640 x 480 (30 fps)		352 x 240 (30 fps)
		720 x 480 (30 fps)	720 x 480 (30 fps)	720 x 480 (30 fps)
			640 x 480 (30 fps)	640 x 480 (30 fps)
			352 x 240 (30 fps)	352 x 240 (30 fps)
720 x 480 (30 fps)		720 x 480 (30 fps)	720 x 480 (30 fps)	720 x 480 (30 fps)
			640 x 480 (30 fps)	640 x 480 (30 fps)
			640 x 480 (30 fps)	352 x 240 (30 fps)
			352 x 240 (30 fps)	352 x 240 (30 fps)
		640 x 480 (30 fps)	640 x 480 (30 fps)	640 x 480 (30 fps)
			352 x 240 (30 fps)	352 x 240 (30 fps)
			352 x 240 (30 fps)	352 x 240 (30 fps)
			352 x 240 (30 fps)	352 x 240 (30 fps)

H.264 + H.264 + H.264 + H.264 / MJPEG					
H.264-1	H.264-2	H.264-3	H.264-4 / MJPEG		
800 x 600 (30 fps)	800 x 600 (30 fps)	800 x 600 (30 fps)	352 x 240 (30 fps)		
		720 x 480 (30 fps)	720 x 480 (30 fps)	720 x 480 (30 fps)	
			640 x 480 (30 fps)	640 x 480 (30 fps)	
		720 x 480 (30 fps)	640 x 480 (30 fps)	640 x 480 (30 fps)	352 x 240 (30 fps)
	640 x 480 (30 fps)		352 x 240 (30 fps)	640 x 480 (30 fps)	
			720 x 480 (30 fps)	720 x 480 (30 fps)	
	640 x 480 (30 fps)		640 x 480 (30 fps)	640 x 480 (30 fps)	352 x 240 (30 fps)
		352 x 240 (30 fps)	352 x 240 (30 fps)	352 x 240 (30 fps)	
	720 x 480 (30 fps)	720 x 480 (30 fps)	720 x 480 (30 fps)	720 x 480 (30 fps)	
			640 x 480 (30 fps)	640 x 480 (30 fps)	640 x 480 (30 fps)
				352 x 240 (30 fps)	352 x 240 (30 fps)
		640 x 480 (30 fps)	640 x 480 (30 fps)	640 x 480 (30 fps)	352 x 240 (30 fps)
352 x 240 (30 fps)			352 x 240 (30 fps)	352 x 240 (30 fps)	
640 x 480 (30 fps)		640 x 480 (30 fps)	640 x 480 (30 fps)	640 x 480 (30 fps)	
			352 x 240 (30 fps)	352 x 240 (30 fps)	
		352 x 240 (30 fps)	352 x 240 (30 fps)	352 x 240 (30 fps)	352 x 240 (30 fps)
640 x 480 (30 fps)	640 x 480 (30 fps)	640 x 480 (30 fps)	640 x 480 (30 fps)		
		352 x 240 (30 fps)	352 x 240 (30 fps)		
352 x 240 (30 fps)	352 x 240 (30 fps)	352 x 240 (30 fps)	352 x 240 (30 fps)		

## 2M Real time / 3M / 5M- Triple Streams

H.264-1 + H.264-2 + H.264-3 / MJPEG		
H.264-1	H.264-2	H.264-3 / MJPEG
2592 x 1944 (10 fps)	720 x 480 (10 fps)	720 x 480 (10 fps)
		640 x 480 (10 fps)
		352 x 240 (10 fps)
	640 x 480 (10 fps)	640 x 480 (10 fps)
		640 x 480 (10 fps)
		352 x 240 (10 fps)

\*The resolution is for 5M Model only.

H.264-1 + H.264-2 + H.264-3 / MJPEG		
H.264-1	H.264-2	H.264-3 / MJPEG
2048 x 1536 (15 fps)	1280 x 720 (15 fps)	720 x 480 (15 fps)
		640 x 480 (15 fps)
		352 x 240 (15 fps)
	800 x 600 (15 fps)	800 x 600 (15 fps)
		720 x 480 (15 fps)
		640 x 480 (15 fps)
	720 x 480 (15 fps)	352 x 240 (15 fps)
		720 x 480 (15 fps)
		640 x 480 (15 fps)
	640 x 480 (15 fps)	352 x 240 (15 fps)
		640 x 480 (15 fps)
		352 x 240 (15 fps)
	352 x 240 (15 fps)	352 x 240 (15 fps)

\*The resolution is for 3M & 5M Model only.

H.264-1 + H.264-2 + H.264-3 / MJPEG		
H.264-1	H.264-2	H.264-3 / MJPEG
1920 x 1080 (15 fps)	1280 x 1024 (15 fps)	1280 x 720 (15 fps)
		800 x 600 (30 fps)
		720 x 480 (30 fps)
		640 x 480 (30 fps)
		352 x 240 (30 fps)
	1280 x 720 (15 fps)	1280 x 720 (30 fps)
		800 x 600 (30 fps)
		720 x 480 (30 fps)
	1280 x 720 (30 fps)	640 x 480 (30 fps)
		352 x 240 (30 fps)
		800 x 600 (30 fps)
	1024 x 768 (30 fps)	720 x 480 (30 fps)
		640 x 480 (30 fps)
		352 x 240 (30 fps)
		800 x 600 (30 fps)
	800 x 600 (30 fps)	720 x 480 (30 fps)
		640 x 480 (30 fps)
		352 x 240 (30 fps)
		720 x 480 (30 fps)
	720 x 480 (30 fps)	640 x 480 (30 fps)
		352 x 240 (30 fps)
		640 x 480 (30 fps)
	640 x 480 (30 fps)	352 x 240 (30 fps)
		352 x 240 (30 fps)
1920 x 1080 (30 fps)	352 x 240 (30 fps)	352 x 240 (30 fps)

H.264-1 + H.264-2 + H.264-3 / MJPEG		
H.264-1	H.264-2	H.264-3 / MJPEG
1280 x 1024 (15 fps)	1280 x 1024 (15 fps)	1280 x 720 (30 fps)
		800 x 600 (30 fps)
	1280 x 1024 (30 fps)	720 x 480 (30 fps)
		640 x 480 (30 fps)
	1280 x 720 (15 fps)	352 x 240 (30 fps)
		1280 x 720 (30 fps)
1280 x 720 (30 fps)	800 x 600 (30 fps)	
	720 x 480 (30 fps)	
1024 x 768 (30 fps)	640 x 480 (30 fps)	
	352 x 240 (30 fps)	
1280 x 1024 (30 fps)	1280 x 720 (30 fps)	800 x 600 (30 fps)
	1024 x 768 (30 fps)	720 x 480 (30 fps)
		640 x 480 (30 fps)
		352 x 240 (30 fps)
	800 x 600 (30 fps)	720 x 480 (30 fps)
		640 x 480 (30 fps)
		352 x 240 (30 fps)
	720 x 480 (30 fps)	640 x 480 (30 fps)
352 x 240 (30 fps)		
352 x 240 (30 fps)		
640 x 480 (30 fps)	640 x 480 (30 fps)	
	352 x 240 (30 fps)	
352 x 240 (30 fps)	352 x 240 (30 fps)	
1280 x 720 (15 fps)	1280 x 720 (30 fps)	1280 x 720 (30 fps)
1280 x 720 (30 fps)	1280 x 720 (30 fps)	800 x 600 (30 fps)
		720 x 480 (30 fps)
		640 x 480 (30 fps)
		352 x 240 (30 fps)
	1024 x 768 (30 fps)	800 x 600 (30 fps)
		720 x 480 (30 fps)
		640 x 480 (30 fps)
		352 x 240 (30 fps)
	800 x 600 (30 fps)	800 x 600 (30 fps)
		720 x 480 (30 fps)
		640 x 480 (30 fps)
		352 x 240 (30 fps)
	720 x 480 (30 fps)	720 x 480 (30 fps)
		640 x 480 (30 fps)
352 x 240 (30 fps)		
352 x 240 (30 fps)		
640 x 480 (30 fps)	640 x 480 (30 fps)	
	352 x 240 (30 fps)	
352 x 240 (30 fps)	352 x 240 (30 fps)	
1024 x 768 (30 fps)	1024 x 768 (30 fps)	800 x 600 (30 fps)
		720 x 480 (30 fps)
		640 x 480 (30 fps)
		352 x 240 (30 fps)
	800 x 600 (30 fps)	800 x 600 (30 fps)
		720 x 480 (30 fps)
		640 x 480 (30 fps)
		352 x 240 (30 fps)
	720 x 480 (30 fps)	720 x 480 (30 fps)
		640 x 480 (30 fps)
		352 x 240 (30 fps)
		352 x 240 (30 fps)
	640 x 480 (30 fps)	640 x 480 (30 fps)
		352 x 240 (30 fps)
352 x 240 (30 fps)	352 x 240 (30 fps)	

H.264-1 + H.264-2 + H.264-3 / MJPEG			
H.264-1	H.264-2	H.264-3 / MJPEG	
800 x 600 (30 fps)	800 x 600 (30 fps)	800 x 600 (30 fps)	
		720 x 480 (30 fps)	
		640 x 480 (30 fps)	
		352 x 240 (30 fps)	
	720 x 480 (30 fps)	720 x 480 (30 fps)	720 x 480 (30 fps)
			640 x 480 (30 fps)
			352 x 240 (30 fps)
			352 x 240 (30 fps)
	640 x 480 (30 fps)	640 x 480 (30 fps)	640 x 480 (30 fps)
			352 x 240 (30 fps)
			352 x 240 (30 fps)
			352 x 240 (30 fps)
352 x 240 (30 fps)	352 x 240 (30 fps)	352 x 240 (30 fps)	
		352 x 240 (30 fps)	
		352 x 240 (30 fps)	
		352 x 240 (30 fps)	
720 x 480 (30 fps)	720 x 480 (30 fps)	720 x 480 (30 fps)	
		640 x 480 (30 fps)	
		352 x 240 (30 fps)	
	640 x 480 (30 fps)	640 x 480 (30 fps)	640 x 480 (30 fps)
			352 x 240 (30 fps)
			352 x 240 (30 fps)
640 x 480 (30 fps)	640 x 480 (30 fps)	640 x 480 (30 fps)	
		352 x 240 (30 fps)	
		352 x 240 (30 fps)	
352 x 240 (30 fps)	352 x 240 (30 fps)	352 x 240 (30 fps)	
		352 x 240 (30 fps)	
		352 x 240 (30 fps)	

## 2M Real time / 3M / 5M- Dual Streams

H.264-1 + H.264-2 / MJPEG		
H.264-1	H.264-2 / MJPEG	BNC SUPPORT
2952 x 1944 (10 fps)	720 x 480 (10 fps)	-
	640 x 480 (10 fps)	-
	352 x 240 (10 fps)	-

\*The resolution is for 5M Model only.

H.264-1 + H.264-2 / MJPEG		
H.264-1	H.264-2 / MJPEG	BNC SUPPORT
2048 x 1536 (15 fps)	1280 x 720 (15 fps)	-
	800 x 600 (15 fps)	-
	720 x 480 (15 fps)	-
	640 x 480 (15 fps)	-
	352 x 240 (15 fps)	-

\*The resolution is for 3M & 5M Model only.

H.264-1 + H.264-2 / MJPEG		
H.264-1	H.264-2 / MJPEG	BNC SUPPORT
1920 x 1080 (15 fps)	1920 x 1080 (15 fps)	√
	1280 x 1024 (30 fps)	-
	1280 x 720 (30 fps)	-
	1024 x 768 (30 fps)	-
	800 x 600 (30 fps)	-
1920 x 1080 (30 fps)	720 x 480 (30 fps)	√
	640 x 480 (30 fps)	√
	352 x 240 (30 fps)	√
1280 x 1024 (30 fps)	1280 x 1024 (15 fps)	√
	1280 x 720 (30 fps)	-
	1024 x 768 (30 fps)	-
	800 x 600 (30 fps)	-
	720 x 480 (30 fps)	√
	640 x 480 (30 fps)	√
1280 x 720 (30 fps)	352 x 240 (30 fps)	√
	1280 x 720 (30 fps)	√
	1024 x 768 (30 fps)	-
	800 x 600 (30 fps)	-
	720 x 480 (30 fps)	√
1024 x 768 (30 fps)	640 x 480 (30 fps)	√
	352 x 240 (30 fps)	√
	1024 x 768 (30 fps)	√
	800 x 600 (30 fps)	-
	720 x 480 (30 fps)	√
800 x 600 (30 fps)	640 x 480 (30 fps)	√
	352 x 240 (30 fps)	√
	800 x 600 (30 fps)	√
	720 x 480 (30 fps)	√
720 x 480 (30 fps)	640 x 480 (30 fps)	√
	352 x 240 (30 fps)	√
	720 x 480 (30 fps)	√
640 x 480 (30 fps)	640 x 480 (30 fps)	√
	352 x 240 (30 fps)	√
352 x 240 (30 fps)	352 x 240 (30 fps)	-

## 2M Real time / 3M / 5M- Single Stream

H.264 Only	BNC SUPPORT
2592 x 1944 (10 fps)*	-
2048 x 1536 (15 fps)**	-
1920 x 1080 (30 fps) Low Latency***	-
1920 x 1080 (30 fps)	√
1280 x 1024 (30 fps)	√
1280 x 720 (30 fps)	√
1024 x 768 (30 fps)	√
800 x 600 (30 fps)	√
720 x 480 (30 fps)	√
640 x 480 (30 fps)	√
352 x 240 (30 fps)	-

\* The resolution is for 5M Model only.

\*\* The resolution is for 3M & 5M Model only.

\*\*\* 1920 x 1080 (30 fps) Low Latency does not support BNC, 3DNR, Motion Detection and digital zoom.

MJPEG Only	BNC SUPPORT
1920 x 1080 (30 fps)	√
1280 x 1024 (30 fps)	√
1280 x 720 (30 fps)	√
1024 x 768 (30 fps)	√
800 x 600 (30 fps)	√
720 x 480 (30 fps)	√
640 x 480 (30 fps)	√
352 x 240 (30 fps)	-