



# EMC TEST REPORT

According to

EN 55022:2010+AC:2011 (Class A)  
AS/NZS CISPR22(2009)+A1(2010) (Class A)  
EN 61000-3-2:2006+A1:2009+A2:2009  
EN 61000-3-3:2008

EN 50130-4:2011  
IEC 61000-4-2:2008  
IEC 61000-4-3:2006+A1:2007+A2:2010  
IEC 61000-4-4:2012  
IEC 61000-4-5:2005  
IEC 61000-4-6:2008  
IEC 61000-4-8:2009  
IEC 61000-4-11:2004  
Mains Supply Voltage Variations

Applicant : ERNITEC  
Address : Tempovej 41, 2750 Ballerup, Denmark  
Equipment : Ernitec EDNS V1000, V2000, V2100, V3000 Series  
Model No. : V1xxx, V2xxx, V21xx, V3xxx (x=0~9, A~Z or Space)  
Trade Name : ERNITEC

- The test result refers exclusively to the test presented test model / sample.
- Without written approval of *CerpPASS Technology Corp.* the test report shall not be reproduced except in full.
- This test report is only applicable to European Community.



## Contents

<b>CERTIFICATE OF COMPLIANCE</b> .....	<b>5</b>
<b>1. Summary of Test Procedure and Test Results</b> .....	<b>6</b>
<b>2. Immunity Testing Performance Criteria Definition</b> .....	<b>6</b>
<b>3. Test Configuration of Equipment under Test</b> .....	<b>7</b>
3.1. Feature of Equipment under Test.....	7
3.2. Test Manner .....	7
3.3. Description of Support Systems.....	8
3.4. General Information of Test.....	9
3.5. Measurement Uncertainty .....	9
<b>4. Test of Conducted Emission</b> .....	<b>10</b>
4.1. Test Limit .....	10
4.2. Test Procedures .....	11
4.3. Typical Test Setup .....	11
4.4. Measurement Equipment.....	11
4.5. Test Result and Data of Power Port.....	12
4.6. Test Photographs of Power Port .....	24
4.7. Test Photographs of Telecommunication Port.....	25
<b>5. Test of Radiated Emission</b> .....	<b>26</b>
5.1. Test Limit.....	26
5.2. Test Procedures .....	27
5.3. Typical Test Setup .....	27
5.4. Measurement Equipment.....	28
5.5. Test Result and Data (30MHz ~ 1GHz).....	29
5.6. Test Result and Data (1GHz ~ 6GHz).....	37
5.7. Test Photographs (30MHz ~ 1GHz) .....	41
5.8. Test Photographs (1GHz ~ 6GHz) .....	42
<b>6. Harmonics Test</b> .....	<b>43</b>
6.1. Limits of Harmonics Current Measurement .....	43
6.2. Test Result and Data.....	43
<b>7. Voltage Fluctuations Test</b> .....	<b>44</b>
7.1. Test Procedure .....	44
7.2. Measurement Equipment.....	44
7.3. Test Result and Data.....	45
7.4. Test Photographs .....	47
<b>8. Electrostatic Discharge Immunity Test</b> .....	<b>48</b>
8.1. Test Procedure .....	48
8.2. Test Setup for Tests Performed in Laboratory.....	49
8.3. Test Severity Levels .....	50
8.4. Measurement Equipment.....	50
8.5. Test Result and Data.....	51
8.6. Test Photographs .....	52
<b>9. Radio Frequency electromagnetic field immunity test</b> .....	<b>53</b>
9.1. Test Procedure .....	53



- 9.2. Test Severity Levels ..... 53
- 9.3. Measurement Equipment ..... 53
- 9.4. Test Result and Data ..... 54
- 9.5. Test Photographs ..... 55
- 10. Electrical Fast Transient/ Burst Immunity Test ..... 56**
  - 10.1. Test Procedure ..... 56
  - 10.2. Test Severity Levels ..... 56
  - 10.3. Measurement Equipment ..... 56
  - 10.4. Test Result and Data ..... 57
  - 10.5. Test Photographs ..... 58
- 11. Surge Immunity Test ..... 59**
  - 11.1. Test Procedure ..... 59
  - 11.2. Test Severity Level ..... 59
  - 11.3. Measurement Equipment ..... 60
  - 11.4. Test Result and Data ..... 60
  - 11.5. Test Photographs ..... 61
- 12. Conduction Disturbances induced by Radio-Frequency Fields ..... 63**
  - 12.1. Test Procedure ..... 63
  - 12.2. Test Severity Levels ..... 63
  - 12.3. Measurement Equipment ..... 63
  - 12.4. Test Result and Data ..... 64
  - 12.5. Test Photographs ..... 65
- 13. Power Frequency Magnetic Field Immunity Test ..... 66**
  - 13.1. Test Setup ..... 66
  - 13.2. Test Severity Levels ..... 66
  - 13.3. Measurement Equipment ..... 66
  - 13.4. Test Result and Data ..... 67
  - 13.5. Test Photographs ..... 68
- 14. Voltage Dips and Voltage Interruptions Immunity Test Setup ..... 69**
  - 14.1. Test Conditions ..... 69
  - 14.2. Measurement Equipment ..... 69
  - 14.3. Test Result and Data ..... 70
  - 14.4. Test Photographs ..... 71
- 15. Mains Supply Voltage Variations Test ..... 72**
  - 15.1. Test Conditions ..... 72
  - 15.2. Measurement Equipment ..... 72
  - 15.3. Test Result and Data ..... 72
- Appendix A. Photographs of EUT ..... A1 ~ A6**



**History of this test report**

ORIGINAL.

Additional attachment as following record:

Attachment No.	Issue Date	Description



# CERTIFICATE OF COMPLIANCE

According to

EN 55022:2010+AC:2011 (Class A)	EN 50130-4:2011
AS/NZS CISPR22(2009)+A1(2010) (Class A)	IEC 61000-4-2:2008
EN 61000-3-2:2006+A1:2009+A2:2009	IEC 61000-4-3:2006+A1:2007+A2:2010
EN 61000-3-3:2008	IEC 61000-4-4:2012
	IEC 61000-4-5:2005
	IEC 61000-4-6:2008
	IEC 61000-4-8:2009
	IEC 61000-4-11:2004
	Mains Supply Voltage Variations

Applicant : ERNITEC

---

Address : Tempovej 41, 2750 Ballerup, Denmark

---

Equipment : Ernitec EDNS V1000, V2000, V2100, V3000 Series

---

Model No. : V1xxx, V2xxx, V21xx, V3xxx (x=0~9, A~Z or Space)

---

## I HEREBY CERTIFY THAT :

The measurements shown in this test report were made in accordance with the procedures given in **EUROPEAN COUNCIL DIRECTIVE 2004/108/EC**.

The test was carried out on Mar. 24, 2014 at **CerpPASS Technology Corp.**

Signature

---

Hill Chen  
EMC/RF B.U. Assistant Manager



## 1. Summary of Test Procedure and Test Results

Test Item	Normative References	Test Result
Conducted Emission	EN 55022:2010+AC:2011, AS/NZS CISPR22(2009)+A1(2010)	PASS
Radiated Emission	EN 55022:2010+AC:2011, AS/NZS CISPR22(2009)+A1(2010)	PASS
Harmonics	EN 61000-3-2:2006+A1:2009+A2:2009	N/A
Voltage Fluctuations	EN 61000-3-3:2008	PASS
Electrostatic Discharge Immunity Test (ESD)	IEC 61000-4-2:2008	PASS
Radio Frequency electromagnetic field immunity test (RS)	IEC 61000-4-3:2006+A1:2007+A2:2010	PASS
Electrical Fast Transient/ Burst Immunity Test (EFT)	IEC 61000-4-4:2012	PASS
Surge Immunity Test	IEC 61000-4-5:2005	PASS
Conduction Disturbances induced by Radio-Frequency Fields	IEC 61000-4-6:2008	PASS
Power Frequency Magnetic Field Immunity Test	IEC 61000-4-8:2009	PASS
Voltage Dips and Voltage Interruptions Immunity Test	IEC 61000-4-11:2004	PASS

## 2. Immunity Testing Performance Criteria Definition

- A. Normal performance within limits specified by the manufacture, requestor or purchaser.
- B. Temporary loss of function or degradation of performance which ceases after the disturbance ceases, and from which the equipment under test recovers its normal performance, without operator intervention.
- C. Temporary loss of function or degradation of performance, the correction of which requires operation intervention.
- D. Loss of function or degradation of performance which is not recoverable, owing to damage to hardware or software, or loss of data.



### 3. Test Configuration of Equipment under Test

#### 3.1. Feature of Equipment under Test

Please refer to the user's manual.

#### 3.2. Test Manner

- a. During testing, the interface cables and equipment positions were varied according to Europe Standard EN55022 Class A.
- b. The complete test system included remote workstation, Monitor, Keyboard, Mouse, Printer, Alarm and EUT for EMI test. The remote workstation included Notebook and IP CAM.
- c. The complete test system included remote workstation, Monitor, Keyboard, Mouse, Alarm and EUT for EMS test. The remote workstation included Notebook and IP CAM.
- d. The test modes of conduction and radiation test as follow:  
Test Mode 1. VGA + HDMI 1080P + LINK LAN (1Gbps), Adapter: LTE60E-S2-1  
Test Mode 2. VGA + HDMI 1080P + LINK LAN (1Gbps), Adapter: LTE90E-S2-1
- e. The test modes of disturbances at telecommunication ports test as follow:  
Test Mode 1. VGA + HDMI 1080P + LINK LAN (1Gbps), Adapter: LTE90E-S2-1  
Test Mode 2. VGA + HDMI 720P + LINK LAN (1Gbps), Adapter: LTE90E-S2-1  
Test Mode 3. VGA + HDMI 1080P + LINK LAN (100Mbps), Adapter: LTE90E-S2-1  
Test Mode 4. VGA + HDMI 1080P + LINK LAN (10Mbps), Adapter: LTE90E-S2-1  
Test Mode 5. VGA + HDMI 1080P + LINK LAN (1Gbps), Adapter: LTE60E-S2-1  
Test Mode 6. VGA + HDMI 720P + LINK LAN (1Gbps), Adapter: LTE60E-S2-1  
Test Mode 7. VGA + HDMI 1080P + LINK LAN (100Mbps), Adapter: LTE60E-S2-1  
Test Mode 8. VGA + HDMI 1080P + LINK LAN (10Mbps), Adapter: LTE60E-S2-1
- f. The test modes of flicker and EMS test as follow:  
Test Mode 1. VGA + HDMI 1080P + LINK LAN (1Gbps), Adapter: LTE60E-S2-1  
Test Mode 2. VGA + HDMI 1080P + LINK LAN (1Gbps), Adapter: LTE90E-S2-1
- g. An executive program, "PING.EXE" under WIN 7 was executed to transmit and receive data to the remote workstation through LAN.
- h. An executive program, "TFGEN.EXE" under WIN 7 was executed to transmit and receive data to the remote workstation through LAN. During the disturbances at telecommunication port test, the condition of LAN utilization in excess of 10%.



**3.3. Description of Support Systems**

EMI

Device	Manufacturer	Model No.	Description
Monitor	TVS	CM-14VN	Power Cable, Unshielding 1.8m BNC Cable, Shielding 1.8m
Monitor*2	DELL	U2410f	Power Cable, Unshielding 1.8m VGA Cable, Shielding 1.8m HDMI Cable, Shielding 1.8m
Keyboard	DELL	SK-8175	Data Cable, USB Shielding 1.85m
Mouse	DELL	MOC5UO	Data Cable, USB Shielding 1.85m
Printer	HP	D2660	Power Cable, Unshielding 1.8m USB Cable, Shielding 1.6m
Alarm	N/A	N/A	N/A
Remote workstation			
Notebook	SONY	PCG-71218P	Power Cable, Unshielding 1.8m
IP CAM	ERNITEC	CNB-D2310NIRKC1	N/A

Use Cable:

Cable	Quantity	Description
BNC	1	Shielding, 15m
RJ45	1	Unshielding, 15m
BNC loop	15	Shielding, 1.8m
BNC	2	Unshielding, 2.0m

EMS

Device	Manufacturer	Model No.	Description
Monitor	TVS	CM-14VN	Power Cable, Unshielding 1.8m BNC Cable, Shielding 1.8m
Monitor	DELL	U2410f	Power Cable, Unshielding 1.8m VGA Cable, Shielding 1.8m
Monitor	DELL	2408WFPb	Power Cable, Unshielding 1.8m HDMI Cable, Shielding 1.8m
Keyboard	DELL	SK-8175	Data Cable, USB Shielding 1.85m
Mouse	DELL	MOC5UO	Data Cable, USB Shielding 1.85m
Alarm	N/A	N/A	N/A
Remote workstation			
Notebook	DELL	VOSTRO 3700	Power Cable, Unshielding 1.8m
IP CAM	ERNITEC	CNB-D2310NIRKC1	N/A

Use Cable:

Cable	Quantity	Description
BNC	1	Shielding, 15m
RJ45	1	Unshielding, 15m
BNC loop	15	Shielding, 1.8m
BNC	2	Unshielding, 2.0m





### 3.4. General Information of Test

Test Site :	CerpPASS Technology Corp. 2F-11, No. 3, Yuan Qu St., (Nankang Software Park), Taipei, Taiwan 115, R.O.C.
Test Site Location (OATS2-SD) :	No.68-1, Shihbachongsi, Shihding Township, Taipei City 223, Taiwan, R.O.C.
FCC Registration Number :	TW1049, TW1061, 390316, 488071
IC Registration Number :	4934B-1, 4934D-1
VCCI Registration Number :	T-1173 for Telecommunication Test C-4139 for Conducted emission test R-3428 for Radiated emission test G-97 for radiated disturbance above 1GHz
Frequency Range Investigated :	Conducted Emission Test: from 150kHz to 30 MHz Radiated Emission Test: from 30 MHz to 6,000 MHz
Test Distance :	The test distance of radiated emission below 1GHz from antenna to EUT is 10 M. The test distance of radiated emission above 1GHz from antenna to EUT is 3 M.

### 3.5. Measurement Uncertainty

Measurement Item	Measurement Frequency	Polarization	Uncertainty
Conducted Emission	9 kHz ~ 30 MHz	LINE / NEUTRAL	3.25 dB
Radiated Emission	30 MHz ~ 1,000 MHz	Vertical / Horizontal	3.93 dB
	1,000 MHz ~ 18,000 MHz	Vertical / Horizontal	5.18 dB



## 4. Test of Conducted Emission

### 4.1. Test Limit

Conducted Emissions were measured from 150 kHz to 30 MHz with a bandwidth of 9 kHz and return leads of the EUT according to the methods defined in European Standard EN 55022. The EUT was placed on a nonmetallic stand in a shielded room 0.8 meters above the ground plane as shown in section 4.2. The interface cables and equipment positioning were varied within limits of reasonable applications to determine the position producing maximum conducted emissions.

**Table 1 Class A Line Conducted Emission Limits**

Frequency range (MHz)	Limits (dB $\mu$ V)	
	Quasi Peak	Average
0.15 to 0.50	79	66
0.50 to 30	73	60

Note : The lower limits shall apply at the transition frequencies.

**Table 2 - Limits of conducted common mode (asymmetric mode) disturbance at telecommunication ports in the frequency range 0.15 MHz to 30 MHz for class A equipment.**

Frequency range (MHz)	Voltage limits dB( $\mu$ V)		Current limits dB( $\mu$ A)	
	Quasi-peak	Average	Quasi-peak	Average
0.15 to 0.5	97 to 87	84 to 74	53 to 43	40 to 30
0.5 to 30	87	74	43	30

Note 1: The limits decrease linearly with the logarithm of the frequency in the range 0.15 to 0.5 MHz.  
 Note 2 : The current and voltage disturbance limits are derived for use with an impedance stabilization network (ISN) which presents a common mode (asymmetric mode) impedance of  $150\Omega$  to the telecommunication under test (conversion factor is  $20 \log_{10} 150/1 = 44\text{dB}$ ).

### 4.2. Test Procedures

- a. The EUT was placed on a desk 0.8 meters height from the metal ground plane and 0.4 meter from the conducting wall of the shielding room and it was kept at least 0.8 meters from any other grounded conducting surface.
- b. Connect EUT to the power mains through a line impedance stabilization network (LISN).
- c. All the support units are connecting to the other LISN.
- d. The LISN provides 50 ohm coupling impedance for the measuring instrument.
- e. The CISPR states that a 50 ohm, 50 micro-Henry LISN should be used.
- f. Both sides of AC line were checked for maximum conducted interference.
- g. The frequency range from 150 kHz to 30 MHz was searched
- h. Set the test-receiver system to Peak Detect Function and Specified Bandwidth with Maximum Hold Mode.

### 4.3. Typical Test Setup

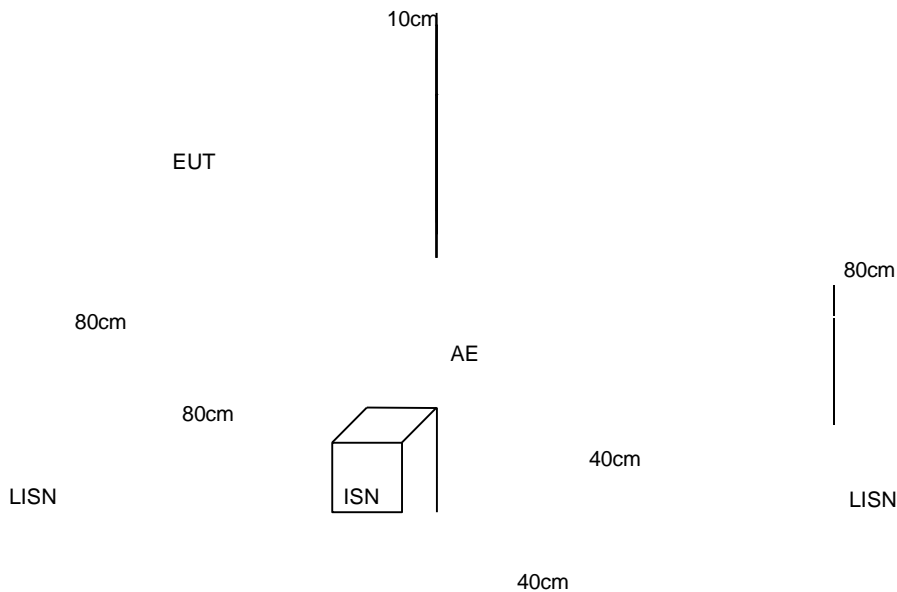

### 4.4. Measurement Equipment

Instrument	Manufacturer	Model No.	Serial No.	Calibration Date	Valid Date
EMI Receiver	R&S	ESCI	100821	2013/09/18	2014/09/17
LISN	Rolf Heine	NNB-2/16Z	02/10191	2013/09/30	2014/09/29
LISN	Schwarzbeck	NSLK 8127	8127-568	2013/08/30	2014/08/29
ISN	TESEQ GMBH	ISN T8	34441	2012/08/28	2014/08/27



### 4.5. Test Result and Data of Power Port

#### 4.5.1 Conducted Emission for Power Port Test Data

Power	: AC 230V	Pol/Phase	: LINE
Test Mode 1	: VGA + HDMI 1080P + LINK LAN (1Gbps), Adapter: LTE60E-S2-1	Temperature	: 22 °C
Test Date	: Mar. 18, 2014	Humidity	: 54 %
Memo	:	Atmospheric Pressure	: 987 hpa

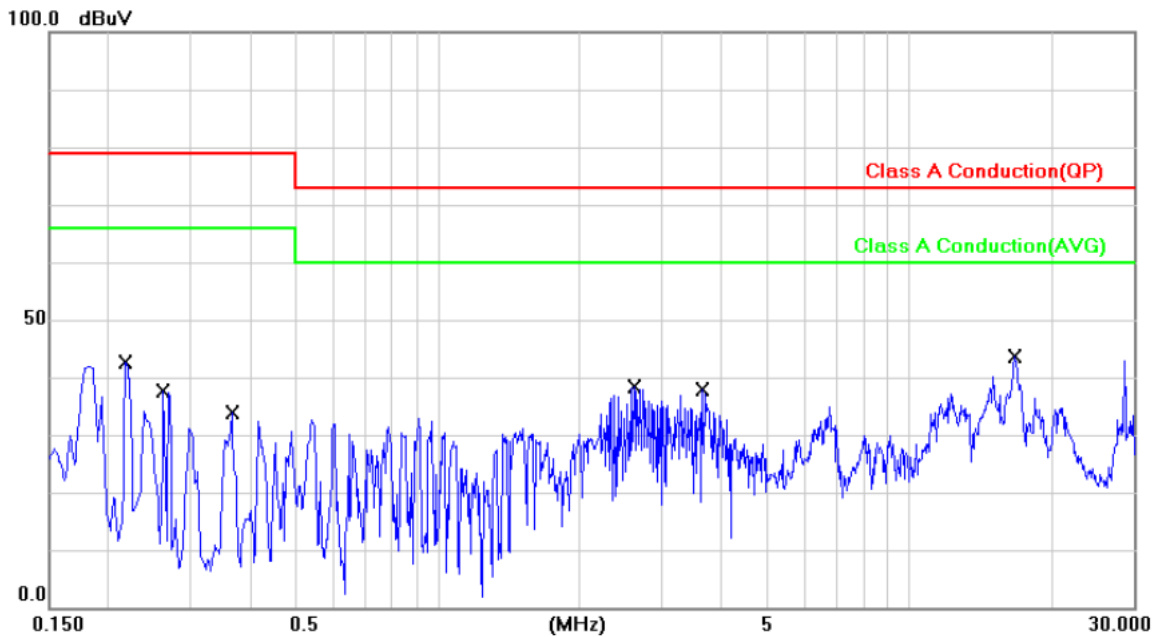

No.	Frequency (MHz)	Factor (dB)	Reading (dBuV)	Level (dBuV)	Limit (dBuV)	Margin (dB)	Detector	P/F
1	0.2180	0.08	35.11	35.19	79.00	-43.81	QP	P
2	0.2180	0.08	12.97	13.05	66.00	-52.95	AVG	P
3	0.2620	0.08	31.32	31.40	79.00	-47.60	QP	P
4	0.2620	0.08	8.10	8.18	66.00	-57.82	AVG	P
5	0.3660	0.09	32.01	32.10	79.00	-46.90	QP	P
6	0.3660	0.09	25.94	26.03	66.00	-39.97	AVG	P
7	2.6140	0.21	32.68	32.89	73.00	-40.11	QP	P
8	2.6140	0.21	19.13	19.34	60.00	-40.66	AVG	P
9	3.6540	0.24	33.10	33.34	73.00	-39.66	QP	P
10	3.6540	0.24	18.30	18.54	60.00	-41.46	AVG	P
11	16.7620	0.55	38.25	38.80	73.00	-34.20	QP	P
12	16.7620	0.55	28.80	29.35	60.00	-30.65	AVG	P

Note: Level = Reading + Factor  
Margin = Level – Limit  
Factor = (LISN or ISN or PLC or Current Probe) Factor + Cable Loss + Attenuator



Power	: AC 230V	Pol/Phase	: NEUTRAL
Test Mode 1	: VGA + HDMI 1080P + LINK LAN (1Gbps), Adapter: LTE60E-S2-1	Temperature	: 22 °C
Test Date	: Mar. 18, 2014	Humidity	: 54 %
Memo	:	Atmospheric Pressure	: 987 hpa

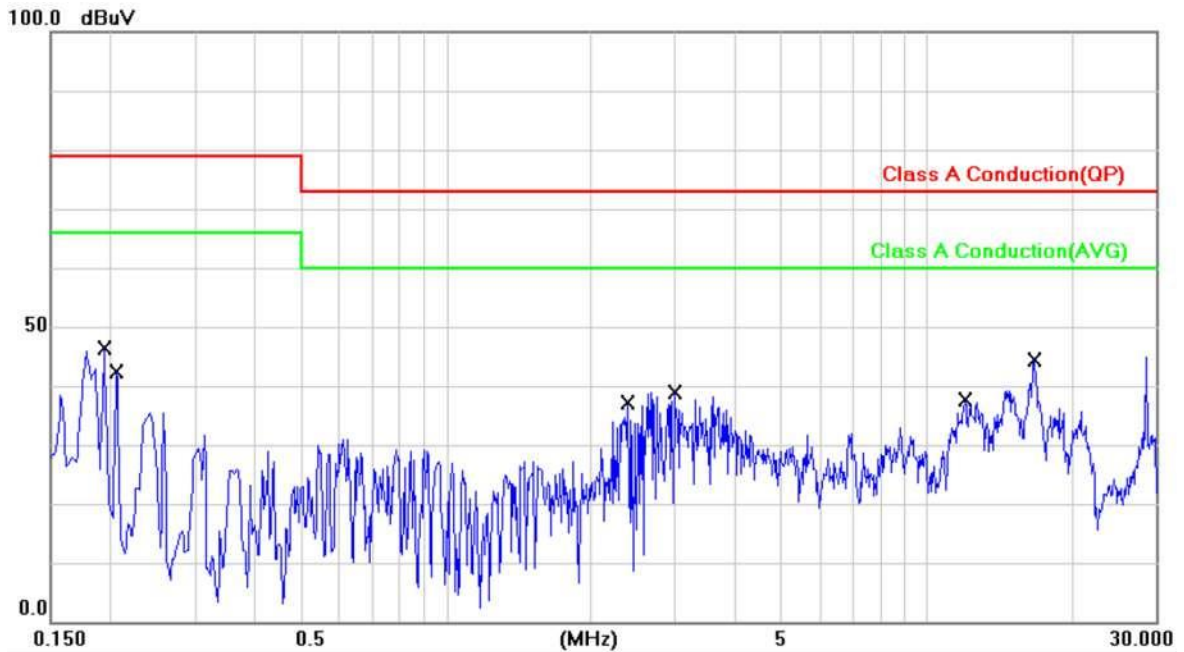

No.	Frequency (MHz)	Factor (dB)	Reading (dBuV)	Level (dBuV)	Limit (dBuV)	Margin (dB)	Detector	P/F
1	0.1940	0.07	38.14	38.21	79.00	-40.79	QP	P
2	0.1940	0.07	17.34	17.41	66.00	-48.59	AVG	P
3	0.2060	0.07	36.96	37.03	79.00	-41.97	QP	P
4	0.2060	0.07	16.32	16.39	66.00	-49.61	AVG	P
5	2.3860	0.19	33.62	33.81	73.00	-39.19	QP	P
6	2.3860	0.19	16.44	16.63	60.00	-43.37	AVG	P
7	2.9820	0.21	33.51	33.72	73.00	-39.28	QP	P
8	2.9820	0.21	17.86	18.07	60.00	-41.93	AVG	P
9	12.0140	0.45	30.81	31.26	73.00	-41.74	QP	P
10	12.0140	0.45	21.39	21.84	60.00	-38.16	AVG	P
11	16.7740	0.56	37.76	38.32	73.00	-34.68	QP	P
12	16.7740	0.56	28.03	28.59	60.00	-31.41	AVG	P

Note: Level = Reading + Factor  
Margin = Level – Limit  
Factor = (LISN or ISN or PLC or Current Probe) Factor + Cable Loss + Attenuator



Power	: AC 230V	Pol/Phase	: LINE
Test Mode 2	: VGA + HDMI 1080P + LINK LAN (1Gbps), Adapter: LTE90E-S2-1	Temperature	: 22 °C
Test Date	: Mar. 18, 2014	Humidity	: 54 %
Memo	:	Atmospheric Pressure	: 987 hpa

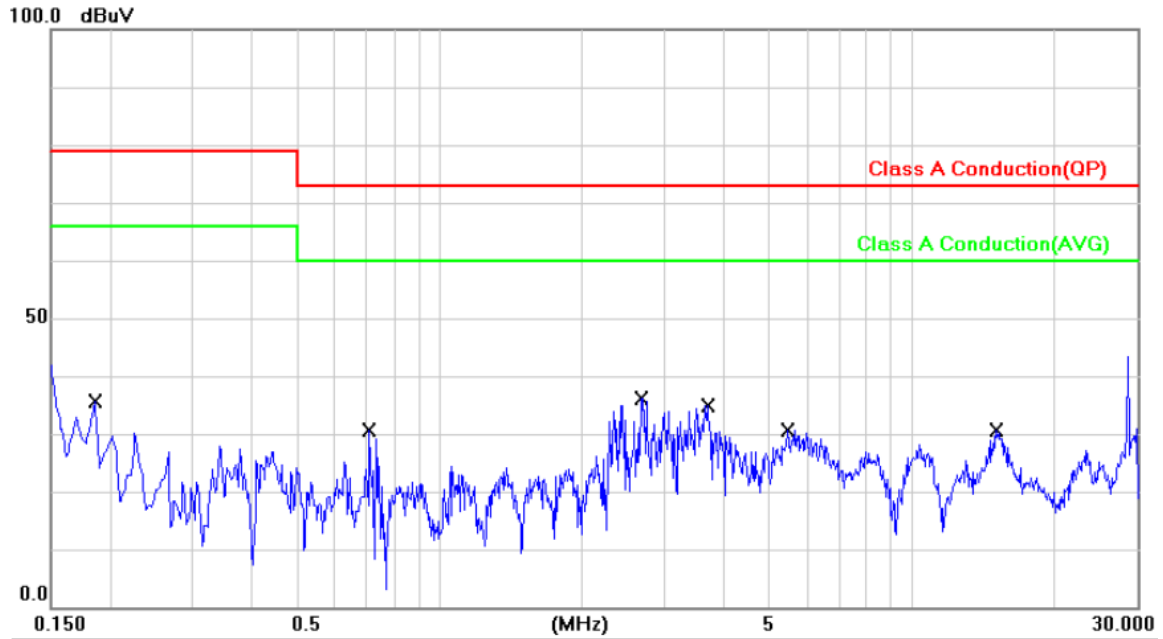

No.	Frequency (MHz)	Factor (dB)	Reading (dBuV)	Level (dBuV)	Limit (dBuV)	Margin (dB)	Detector	P/F
1	0.1860	0.08	31.19	31.27	79.00	-47.73	QP	P
2	0.1860	0.08	19.22	19.30	66.00	-46.70	AVG	P
3	0.7100	0.11	25.59	25.70	73.00	-47.30	QP	P
4	0.7100	0.11	15.57	15.68	60.00	-44.32	AVG	P
5	2.6780	0.21	30.91	31.12	73.00	-41.88	QP	P
6	2.6780	0.21	18.92	19.13	60.00	-40.87	AVG	P
7	3.6820	0.25	30.16	30.41	73.00	-42.59	QP	P
8	3.6820	0.25	18.07	18.32	60.00	-41.68	AVG	P
9	5.4740	0.30	26.15	26.45	73.00	-46.55	QP	P
10	5.4740	0.30	20.94	21.24	60.00	-38.76	AVG	P
11	15.1140	0.52	25.56	26.08	73.00	-46.92	QP	P
12	15.1140	0.52	19.70	20.22	60.00	-39.78	AVG	P

Note: Level = Reading + Factor  
Margin = Level – Limit  
Factor = (LISN or ISN or PLC or Current Probe) Factor + Cable Loss + Attenuator



Power	: AC 230V	Pol/Phase	: NEUTRAL
Test Mode 2	: VGA + HDMI 1080P + LINK LAN (1Gbps), Adapter: LTE90E-S2-1	Temperature	: 22 °C
Test Date	: Mar. 18, 2014	Humidity	: 54 %
Memo	:	Atmospheric Pressure	: 987 hpa

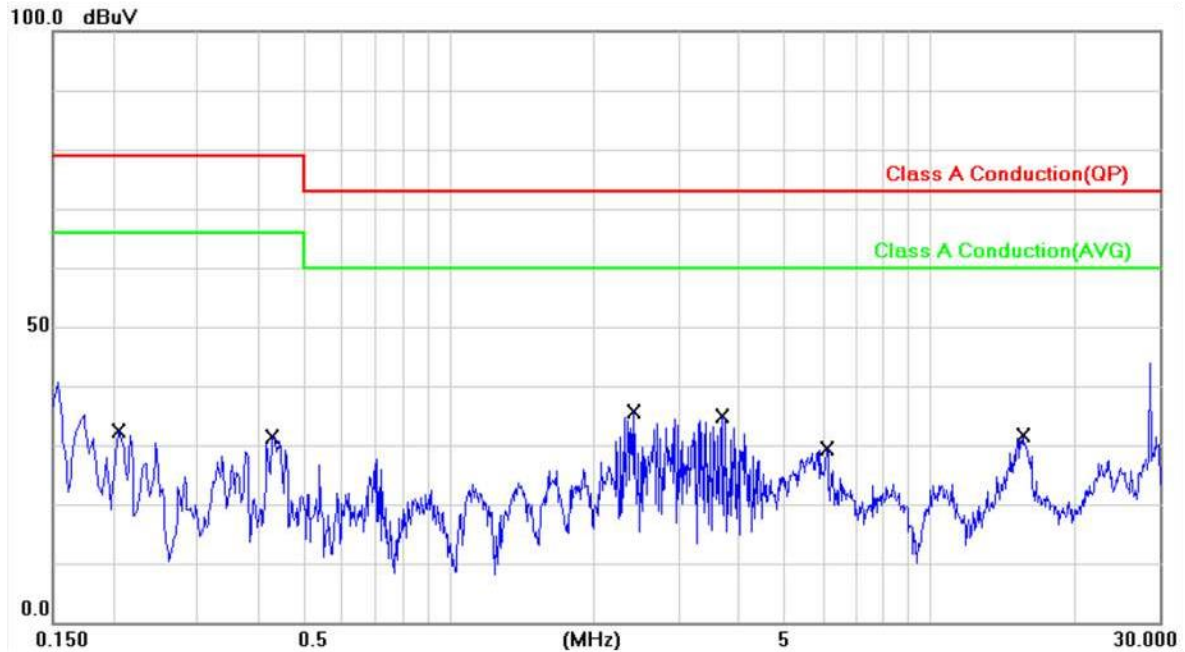

No.	Frequency (MHz)	Factor (dB)	Reading (dBuV)	Level (dBuV)	Limit (dBuV)	Margin (dB)	Detector	P/F
1	0.2060	0.07	32.60	32.67	79.00	-46.33	QP	P
2	0.2060	0.07	23.59	23.66	66.00	-42.34	AVG	P
3	0.4300	0.09	32.37	32.46	79.00	-46.54	QP	P
4	0.4300	0.09	25.42	25.51	66.00	-40.49	AVG	P
5	2.4340	0.19	30.89	31.08	73.00	-41.92	QP	P
6	2.4340	0.19	19.67	19.86	60.00	-40.14	AVG	P
7	3.7140	0.23	29.97	30.20	73.00	-42.80	QP	P
8	3.7140	0.23	16.97	17.20	60.00	-42.80	AVG	P
9	6.1020	0.30	24.62	24.92	73.00	-48.08	QP	P
10	6.1020	0.30	17.63	17.93	60.00	-42.07	AVG	P
11	15.6340	0.53	27.43	27.96	73.00	-45.04	QP	P
12	15.6340	0.53	21.09	21.62	60.00	-38.38	AVG	P

Note: Level = Reading + Factor  
Margin = Level – Limit  
Factor = (LISN or ISN or PLC or Current Probe) Factor + Cable Loss + Attenuator

Test engineer: Smith



4.5.2 Conducted Emission for Telecommunication Port Test Data

Power	: AC 230V	Temperature	: 22 °C
Test Mode 1	: VGA + HDMI 1080P + LINK LAN (1Gbps), Adapter: LTE90E-S2-1	Humidity	: 54 %
Test Date	: Mar. 18, 2014	Atmospheric Pressure	: 987 hpa

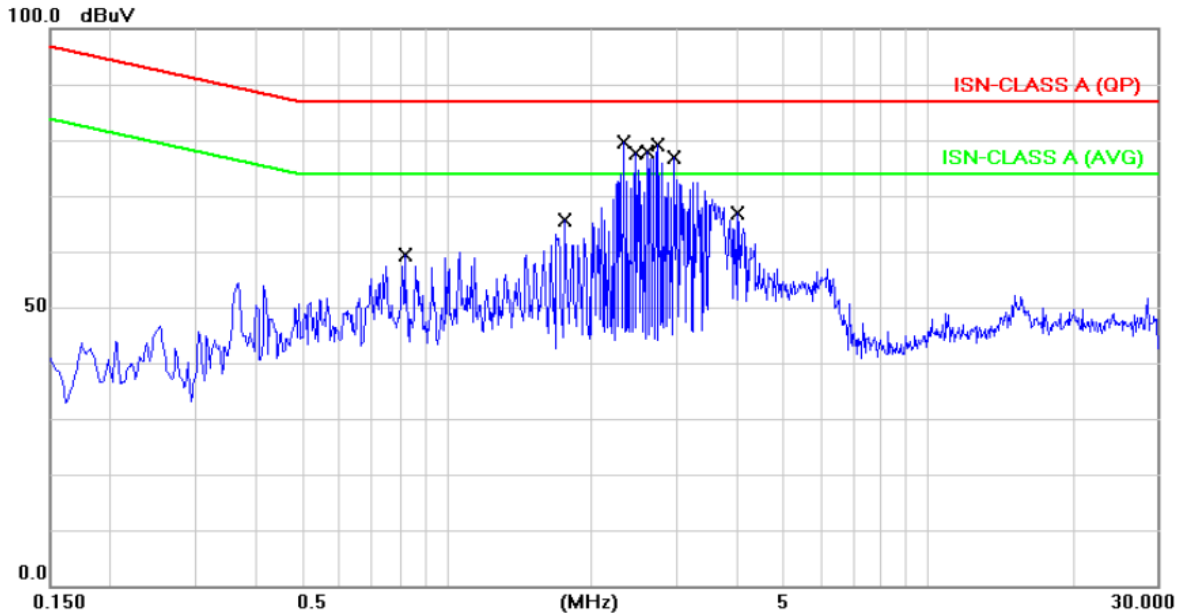

No.	Frequency (MHz)	Factor (dB)	Reading (dBuV)	Level (dBuV)	Limit (dBuV)	Margin (dB)	Detector	P/F
1	0.8180	9.58	47.10	56.68	87.00	-30.32	QP	P
2	0.8180	9.58	36.81	46.39	74.00	-27.61	AVG	P
3	1.7700	9.53	52.50	62.03	87.00	-24.97	QP	P
4	1.7700	9.53	38.65	48.18	74.00	-25.82	AVG	P
5	2.3340	9.55	64.34	73.89	87.00	-13.11	QP	P
6	2.3340	9.55	45.27	54.82	74.00	-19.18	AVG	P
7	2.4620	9.55	64.52	74.07	87.00	-12.93	QP	P
8	2.4620	9.55	46.29	55.84	74.00	-18.16	AVG	P
9	2.6140	9.55	62.46	72.01	87.00	-14.99	QP	P
10	2.6140	9.55	43.76	53.31	74.00	-20.69	AVG	P
11	2.7380	9.55	65.63	75.18	87.00	-11.82	QP	P
12	2.7380	9.55	46.87	56.42	74.00	-17.58	AVG	P
13	2.9660	9.56	61.87	71.43	87.00	-15.57	QP	P
14	2.9660	9.56	44.59	54.15	74.00	-19.85	AVG	P
15	4.0180	9.57	52.69	62.26	87.00	-24.74	QP	P
16	4.0180	9.57	39.40	48.97	74.00	-25.03	AVG	P

Note: Level = Reading + Factor  
Margin = Level – Limit  
Factor = (LISN or ISN or PLC or Current Probe) Factor + Cable Loss + Attenuator





Power	: AC 230V	Temperature	: 22 °C
Test Mode 2	: VGA + HDMI 720P + LINK LAN (1Gbps), Adapter: LTE90E-S2-1	Humidity	: 54 %
Test Date	: Mar. 18, 2014	Atmospheric Pressure	: 987 hpa

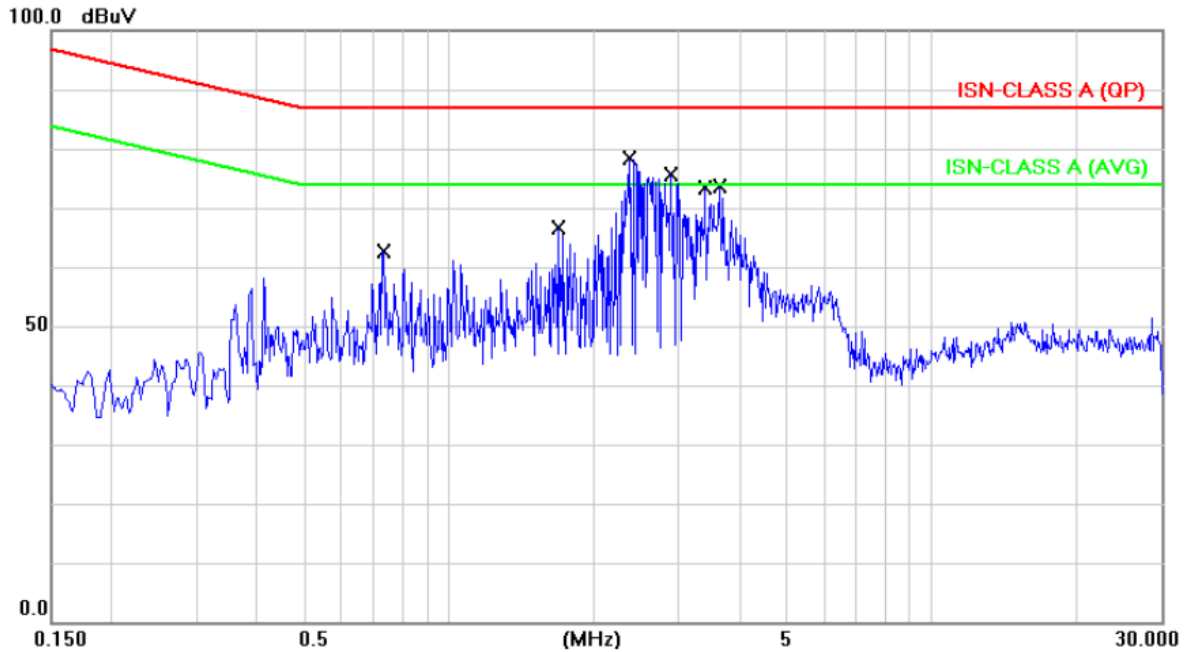

No.	Frequency (MHz)	Factor (dB)	Reading (dBuV)	Level (dBuV)	Limit (dBuV)	Margin (dB)	Detector	P/F
1	0.7340	9.59	48.31	57.90	87.00	-29.10	QP	P
2	0.7340	9.59	38.21	47.80	74.00	-26.20	AVG	P
3	1.6980	9.53	50.77	60.30	87.00	-26.70	QP	P
4	1.6980	9.53	37.47	47.00	74.00	-27.00	AVG	P
5	2.3699	9.55	64.62	74.17	87.00	-12.83	QP	P
6	2.3699	9.55	46.20	55.75	74.00	-18.25	AVG	P
7	2.8860	9.55	60.95	70.50	87.00	-16.50	QP	P
8	2.8860	9.55	42.97	52.52	74.00	-21.48	AVG	P
9	3.4140	9.56	57.22	66.78	87.00	-20.22	QP	P
10	3.4140	9.56	41.89	51.45	74.00	-22.55	AVG	P
11	3.6500	9.57	57.85	67.42	87.00	-19.58	QP	P
12	3.6500	9.57	42.69	52.26	74.00	-21.74	AVG	P

Note: Level = Reading + Factor  
Margin = Level – Limit  
Factor = (LISN or ISN or PLC or Current Probe) Factor + Cable Loss + Attenuator



Power	: AC 230V	Temperature	: 22 °C
Test Mode 3	: VGA + HDMI 1080P + LINK LAN (100Mbps), Adapter: LTE90E-S2-1	Humidity	: 54 %
Test Date	: Mar. 18, 2014	Atmospheric Pressure	: 987 hpa

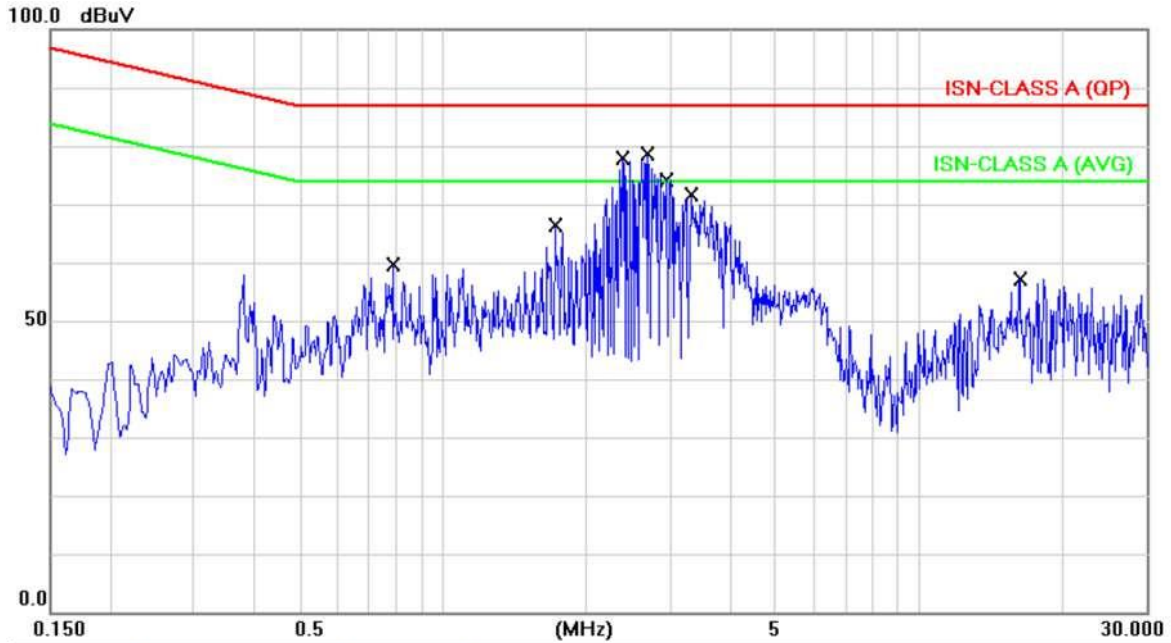

No.	Frequency (MHz)	Factor (dB)	Reading (dBuV)	Level (dBuV)	Limit (dBuV)	Margin (dB)	Detector	P/F
1	0.7860	9.59	45.81	55.40	87.00	-31.60	QP	P
2	0.7860	9.59	35.59	45.18	74.00	-28.82	AVG	P
3	1.7220	9.53	52.62	62.15	87.00	-24.85	QP	P
4	1.7220	9.53	38.60	48.13	74.00	-25.87	AVG	P
5	2.3860	9.55	64.62	74.17	87.00	-12.83	QP	P
6	2.3860	9.55	45.88	55.43	74.00	-18.57	AVG	P
7	2.7020	9.55	64.88	74.43	87.00	-12.57	QP	P
8	2.7020	9.55	47.06	56.61	74.00	-17.39	AVG	P
9	2.9539	9.56	61.95	71.51	87.00	-15.49	QP	P
10	2.9539	9.56	44.64	54.20	74.00	-19.80	AVG	P
11	3.3380	9.56	57.28	66.84	87.00	-20.16	QP	P
12	3.3380	9.56	41.64	51.20	74.00	-22.80	AVG	P
13	16.2300	9.74	46.01	55.75	87.00	-31.25	QP	P
14	16.2300	9.74	43.57	53.31	74.00	-20.69	AVG	P

Note: Level = Reading + Factor  
Margin = Level – Limit  
Factor = (LISN or ISN or PLC or Current Probe) Factor + Cable Loss + Attenuator



Power	: AC 230V	Temperature	: 22 °C
Test Mode 4	: VGA + HDMI 1080P + LINK LAN (10Mbps), Adapter: LTE90E-S2-1	Humidity	: 54 %
Test Date	: Mar. 18, 2014	Atmospheric Pressure	: 987 hpa

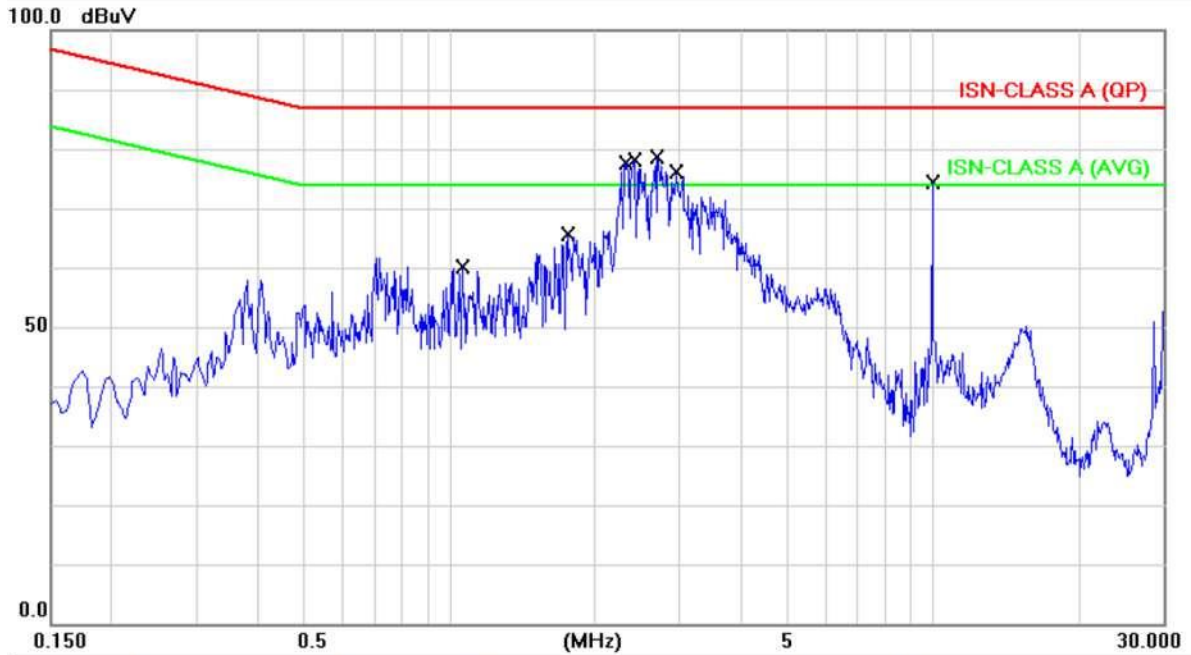

No.	Frequency (MHz)	Factor (dB)	Reading (dBuV)	Level (dBuV)	Limit (dBuV)	Margin (dB)	Detector	P/F
1	1.0660	9.56	48.32	57.88	87.00	-29.12	QP	P
2	1.0660	9.56	36.25	45.81	74.00	-28.19	AVG	P
3	1.7540	9.53	53.06	62.59	87.00	-24.41	QP	P
4	1.7540	9.53	38.84	48.37	74.00	-25.63	AVG	P
5	2.3100	9.54	63.71	73.25	87.00	-13.75	QP	P
6	2.3100	9.54	44.22	53.76	74.00	-20.24	AVG	P
7	2.4219	9.55	64.14	73.69	87.00	-13.31	QP	P
8	2.4219	9.55	45.89	55.44	74.00	-18.56	AVG	P
9	2.6940	9.55	64.99	74.54	87.00	-12.46	QP	P
10	2.6940	9.55	46.98	56.53	74.00	-17.47	AVG	P
11	2.9539	9.56	61.89	71.45	87.00	-15.55	QP	P
12	2.9539	9.56	44.25	53.81	74.00	-20.19	AVG	P
13	10.0000	9.62	64.92	74.54	87.00	-12.46	QP	P
14	10.0000	9.62	46.16	55.78	74.00	-18.22	AVG	P

Note: Level = Reading + Factor  
Margin = Level – Limit  
Factor = (LISN or ISN or PLC or Current Probe) Factor + Cable Loss + Attenuator



Power	: AC 230V	Temperature	: 22 °C
Test Mode 5	: VGA + HDMI 1080P + LINK LAN (1Gbps), Adapter: LTE60E-S2-1	Humidity	: 54 %
Test Date	: Mar. 18, 2014	Atmospheric Pressure	: 987 hpa

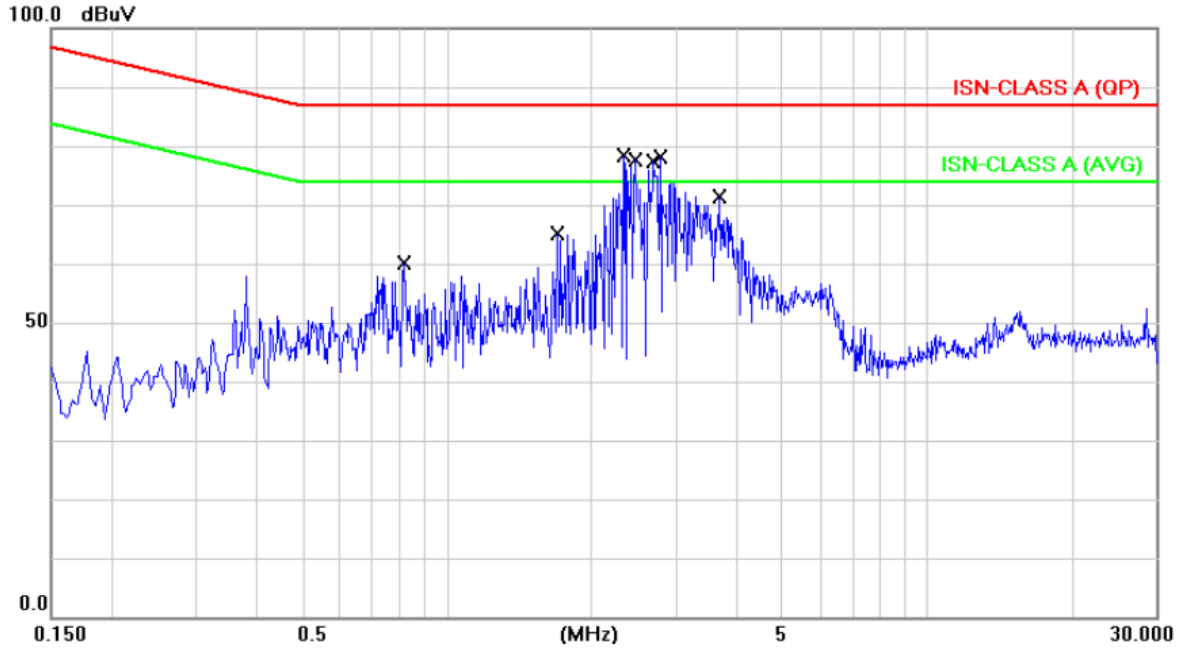

No.	Frequency (MHz)	Factor (dB)	Reading (dBuV)	Level (dBuV)	Limit (dBuV)	Margin (dB)	Detector	P/F
1	0.8139	9.58	46.80	56.38	87.00	-30.62	QP	P
2	0.8139	9.58	36.67	46.25	74.00	-27.75	AVG	P
3	1.7060	9.53	51.80	61.33	87.00	-25.67	QP	P
4	1.7060	9.53	37.88	47.41	74.00	-26.59	AVG	P
5	2.3340	9.55	64.46	74.01	87.00	-12.99	QP	P
6	2.3340	9.55	45.90	55.45	74.00	-18.55	AVG	P
7	2.4700	9.55	63.63	73.18	87.00	-13.82	QP	P
8	2.4700	9.55	45.18	54.73	74.00	-19.27	AVG	P
9	2.6940	9.55	64.74	74.29	87.00	-12.71	QP	P
10	2.6940	9.55	46.79	56.34	74.00	-17.66	AVG	P
11	2.7860	9.55	63.17	72.72	87.00	-14.28	QP	P
12	2.7860	9.55	45.33	54.88	74.00	-19.12	AVG	P
13	3.7140	9.57	57.34	66.91	87.00	-20.09	QP	P
14	3.7140	9.57	41.90	51.47	74.00	-22.53	AVG	P

Note: Level = Reading + Factor  
Margin = Level – Limit  
Factor = (LISN or ISN or PLC or Current Probe) Factor + Cable Loss + Attenuator



Power	: AC 230V	Temperature	: 22 °C
Test Mode 6	: VGA + HDMI 720P + LINK LAN (1Gbps), Adapter: LTE60E-S2-1	Humidity	: 54 %
Test Date	: Mar. 18, 2014	Atmospheric Pressure	: 987 hpa

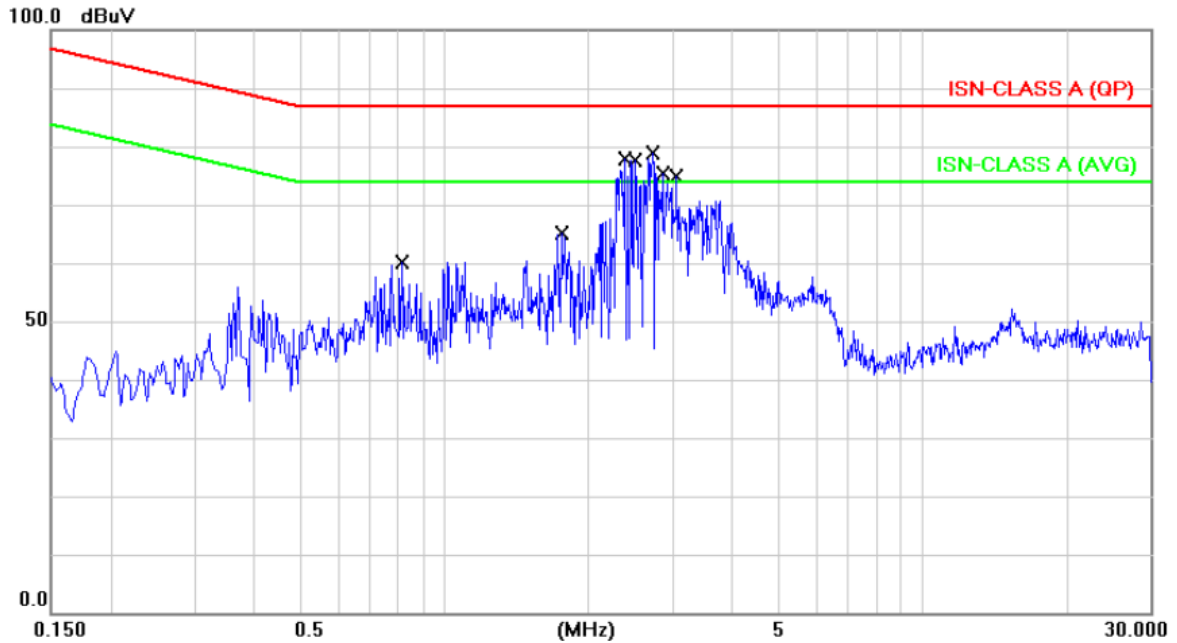

No.	Frequency (MHz)	Factor (dB)	Reading (dBuV)	Level (dBuV)	Limit (dBuV)	Margin (dB)	Detector	P/F
1	0.8139	9.58	47.13	56.71	87.00	-30.29	QP	P
2	0.8139	9.58	36.71	46.29	74.00	-27.71	AVG	P
3	1.7620	9.53	53.16	62.69	87.00	-24.31	QP	P
4	1.7620	9.53	39.09	48.62	74.00	-25.38	AVG	P
5	2.3900	9.55	64.26	73.81	87.00	-13.19	QP	P
6	2.3900	9.55	45.66	55.21	74.00	-18.79	AVG	P
7	2.5059	9.55	63.39	72.94	87.00	-14.06	QP	P
8	2.5059	9.55	44.89	54.44	74.00	-19.56	AVG	P
9	2.7300	9.55	64.58	74.13	87.00	-12.87	QP	P
10	2.7300	9.55	46.93	56.48	74.00	-17.52	AVG	P
11	2.8620	9.55	61.17	70.72	87.00	-16.28	QP	P
12	2.8620	9.55	43.42	52.97	74.00	-21.03	AVG	P
13	3.0579	9.56	59.93	69.49	87.00	-17.51	QP	P
14	3.0579	9.56	42.77	52.33	74.00	-21.67	AVG	P

Note: Level = Reading + Factor  
Margin = Level – Limit  
Factor = (LISN or ISN or PLC or Current Probe) Factor + Cable Loss + Attenuator



Power	: AC 230V	Temperature	: 22 °C
Test Mode 7	: VGA + HDMI 1080P + LINK LAN (100Mbps), Adapter: LTE60E-S2-1	Humidity	: 54 %
Test Date	: Mar. 18, 2014	Atmospheric Pressure	: 987 hpa

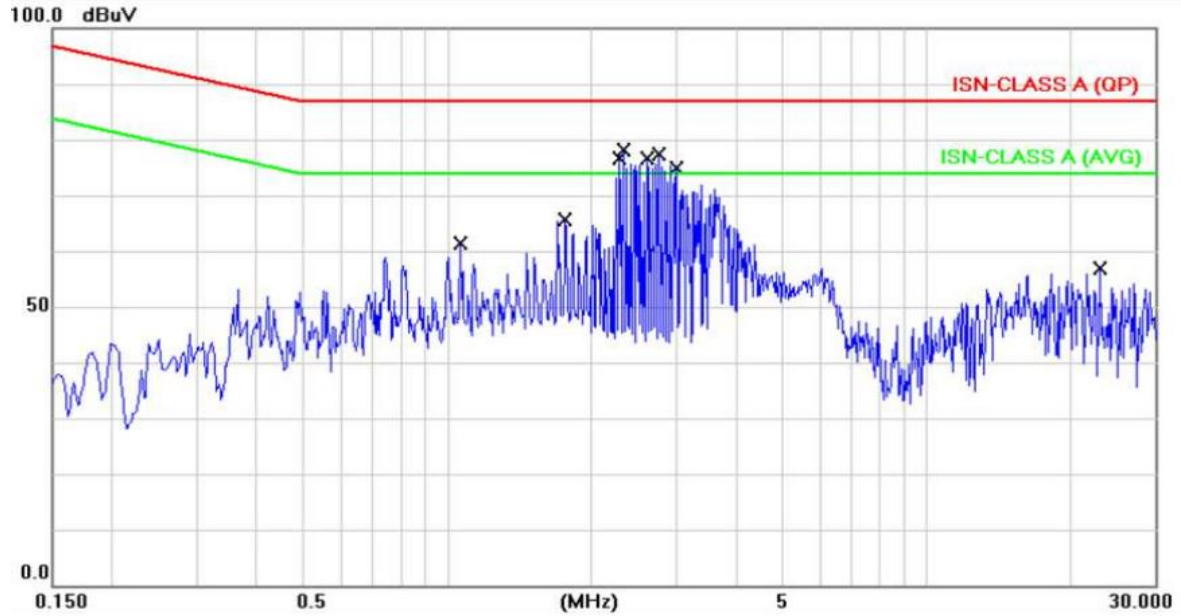

No.	Frequency (MHz)	Factor (dB)	Reading (dBuV)	Level (dBuV)	Limit (dBuV)	Margin (dB)	Detector	P/F
1	1.0660	9.56	48.11	57.67	87.00	-29.33	QP	P
2	1.0660	9.56	36.15	45.71	74.00	-28.29	AVG	P
3	1.7660	9.53	53.04	62.57	87.00	-24.43	QP	P
4	1.7660	9.53	38.76	48.29	74.00	-25.71	AVG	P
5	2.2940	9.54	63.63	73.17	87.00	-13.83	QP	P
6	2.2940	9.54	44.53	54.07	74.00	-19.93	AVG	P
7	2.3340	9.55	64.50	74.05	87.00	-12.95	QP	P
8	2.3340	9.55	45.66	55.21	74.00	-18.79	AVG	P
9	2.6099	9.55	62.24	71.79	87.00	-15.21	QP	P
10	2.6099	9.55	43.60	53.15	74.00	-20.85	AVG	P
11	2.7780	9.55	63.25	72.80	87.00	-14.20	QP	P
12	2.7780	9.55	45.84	55.39	74.00	-18.61	AVG	P
13	3.0140	9.56	61.57	71.13	87.00	-15.87	QP	P
14	3.0140	9.56	44.18	53.74	74.00	-20.26	AVG	P
15	23.1299	9.97	46.15	56.12	87.00	-30.88	QP	P
16	23.1299	9.97	42.87	52.84	74.00	-21.16	AVG	P

Note: Level = Reading + Factor  
Margin = Level – Limit  
Factor = (LISN or ISN or PLC or Current Probe) Factor + Cable Loss + Attenuator



Power	: AC 230V	Temperature	: 22 °C
Test Mode 8	: VGA + HDMI 1080P + LINK LAN (10Mbps), Adapter: LTE60E-S2-1	Humidity	: 54 %
Test Date	: Mar. 18, 2014	Atmospheric Pressure	: 987 hpa

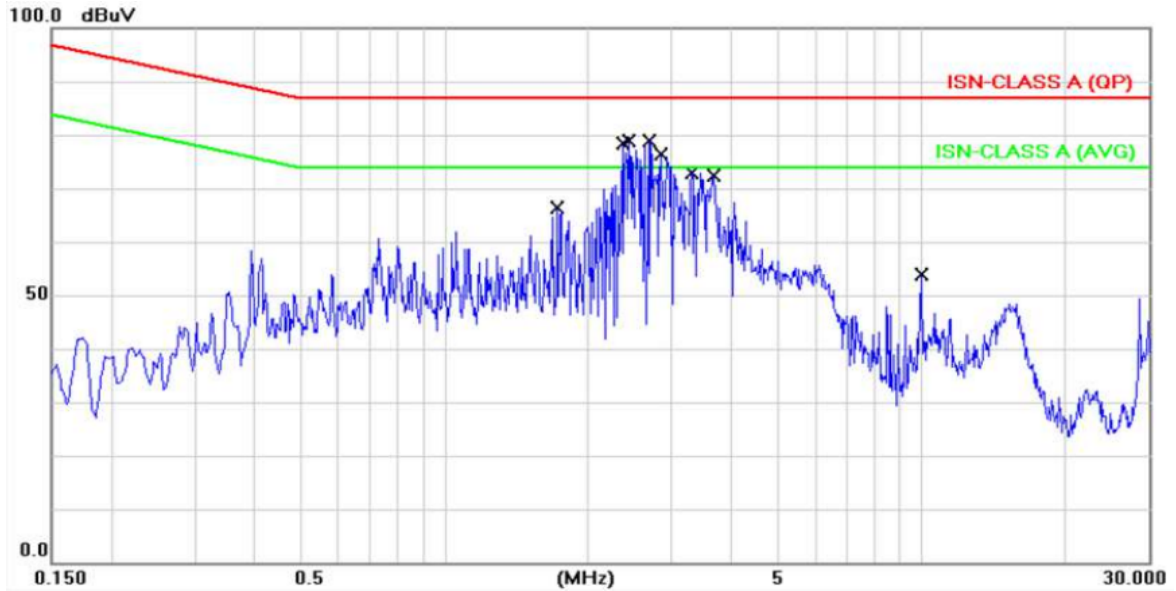

No.	Frequency (MHz)	Factor (dB)	Reading (dBuV)	Level (dBuV)	Limit (dBuV)	Margin (dB)	Detector	P/F
1	1.7340	9.53	52.55	62.08	87.00	-24.92	QP	P
2	1.7340	9.53	38.21	47.74	74.00	-26.26	AVG	P
3	2.3660	9.55	64.76	74.31	87.00	-12.69	QP	P
4	2.3660	9.55	46.20	55.75	74.00	-18.25	AVG	P
5	2.4460	9.55	64.50	74.05	87.00	-12.95	QP	P
6	2.4460	9.55	46.00	55.55	74.00	-18.45	AVG	P
7	2.6860	9.55	64.43	73.98	87.00	-13.02	QP	P
8	2.6860	9.55	46.46	56.01	74.00	-17.99	AVG	P
9	2.8420	9.55	60.11	69.66	87.00	-17.34	QP	P
10	2.8420	9.55	42.64	52.19	74.00	-21.81	AVG	P
11	3.3060	9.56	57.99	67.55	87.00	-19.45	QP	P
12	3.3060	9.56	41.74	51.30	74.00	-22.70	AVG	P
13	3.6740	9.57	58.06	67.63	87.00	-19.37	QP	P
14	3.6740	9.57	42.50	52.07	74.00	-21.93	AVG	P
15	10.0000	9.62	46.83	56.45	87.00	-30.55	QP	P
16	10.0000	9.62	26.76	36.38	74.00	-37.62	AVG	P

Note: Level = Reading + Factor  
Margin = Level – Limit  
Factor = (LISN or ISN or PLC or Current Probe) Factor + Cable Loss + Attenuator

Test engineer: Smith



#### 4.6. Test Photographs of Power Port



Front View

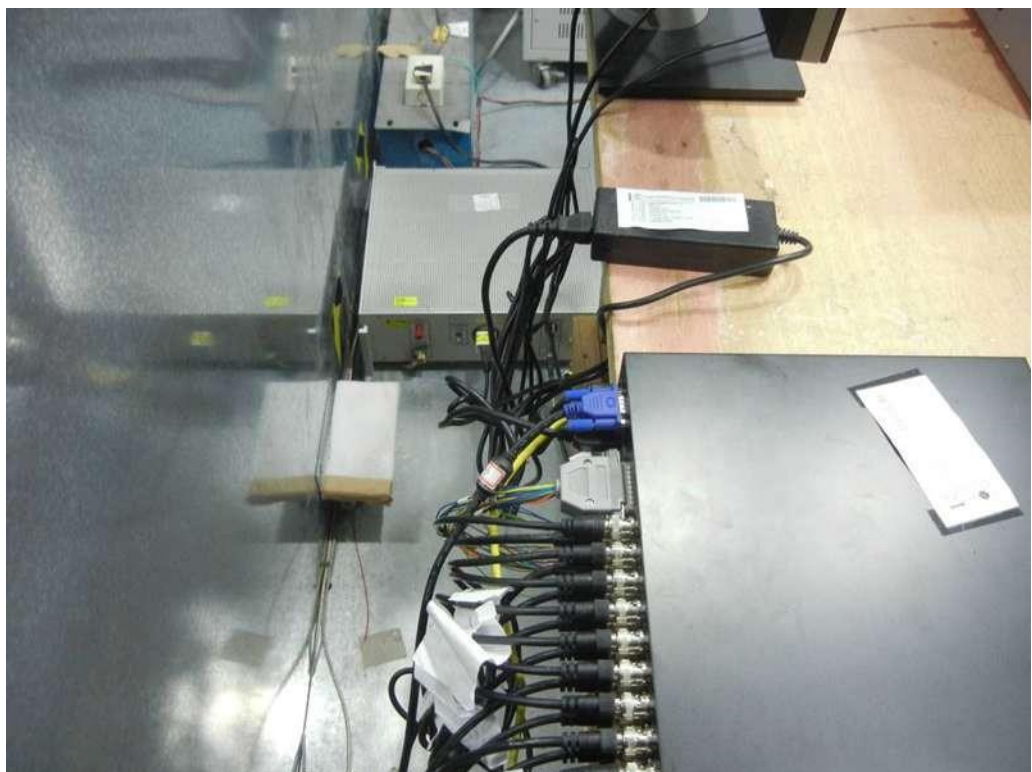

Rear View





#### 4.7. Test Photographs of Telecommunication Port

Rear View

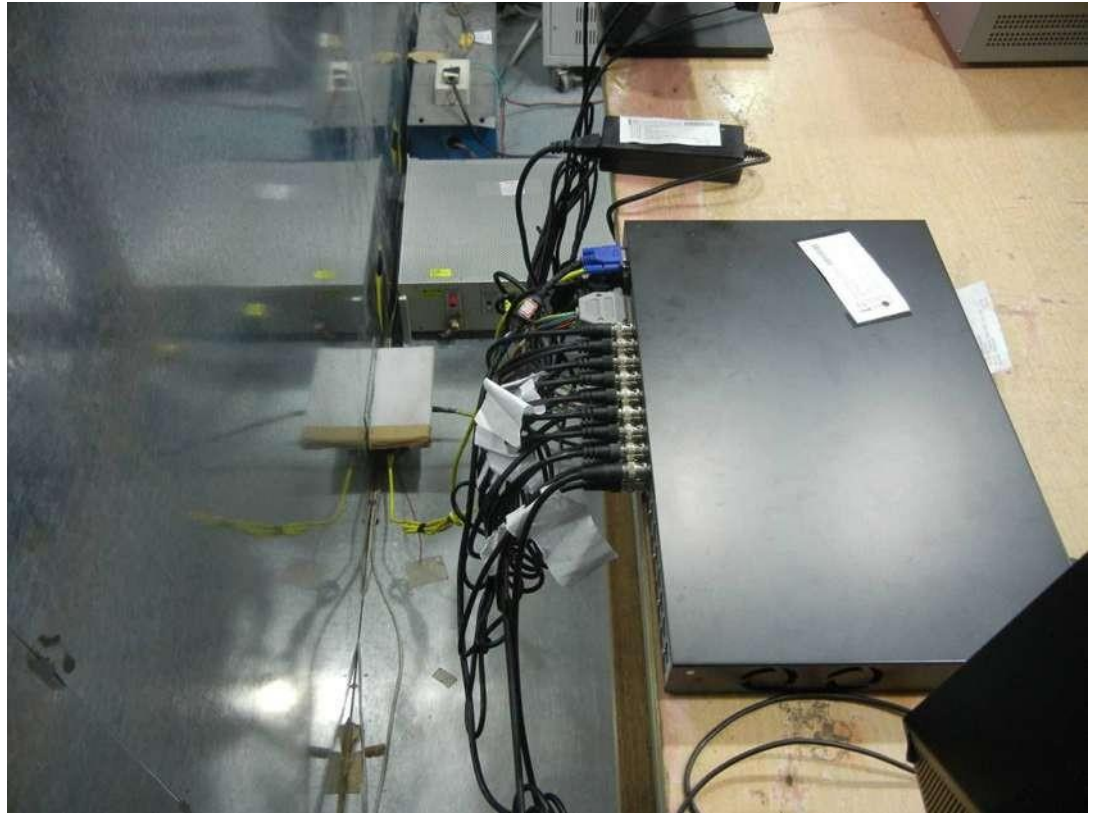



## 5. Test of Radiated Emission

### 5.1. Test Limit

The EUT shall meet the limits of below Table when measured at the measuring distance R in accordance with the methods described in European Standard EN 55022 Clause 10. If the reading on the measuring receiver shows fluctuations close to the limit, the reading shall be observed for at least 15 s at each measurement frequency; the highest reading shall be recorded, with the exception of any brief isolated high reading, which shall be ignored.

Table – Limits for radiated disturbance of class A ITE at a measuring distance of 10 m

Frequency range MHz	Quasi-peak limits dB( $\mu$ V/m)
30 to 230	40
230 to 1000	47
NOTE 1 The lower limit shall apply at the transition frequency.	
NOTE 2 Additional provisions may be required for cases where interference occurs.	

The EUT shall meet the limits of below Table when measured in accordance with the method described in European Standard EN 55022 Clause 10 and the conditional testing procedure described below.

Table – Limits for radiated disturbance of class A ITE at a measuring distance of 3 m

Frequency range GHz	Average limit dB( $\mu$ V/m)	Peak limits dB( $\mu$ V/m)
1 to 3	56	76
3 to 6	60	80
NOTE The lower limit applies at the transition frequency.		

#### - Conditional testing procedure:

The highest internal source of an EUT is defined as the highest frequency generated or used within the EUT or on which the EUT operates or tunes.

If the highest frequency of the internal sources of the EUT is less than 108 MHz, the measurement shall only be made up to 1 GHz.

If the highest frequency of the internal sources of the EUT is between 108 MHz and 500 MHz, the measurement shall only be made up to 2 GHz.

If the highest frequency of the internal sources of the EUT is between 500 MHz and 1 GHz, the measurement shall only be made up to 5 GHz.

If the highest frequency of the internal sources of the EUT is above 1 GHz, the measurement shall be made up to 5 times the highest frequency or 6 GHz, whichever is less.



### 5.2. Test Procedures

- a. The EUT was placed on a rotatable table top 0.8 meter above ground.
- b. The EUT was set 3/10 meters from the interference receiving antenna which was mounted on the top of a variable height antenna tower.
- c. The table was rotated 360 degrees to determine the position of the highest radiation.
- d. The antenna is a half wave dipole and its height is varied between one meter and four meters above ground to find the maximum value of the field strength both horizontal polarization and vertical polarization of the antenna are set to make the measurement.
- e. For each suspected emission the EUT was arranged to its worst case and then tune the antenna tower (from 1 M to 4 M) and turn table (from 0 degree to 360 degrees) to find the maximum reading.
- f. Set the test-receiver system to Peak Detect Function and specified bandwidth with Maximum Hold Mode.
- g. If the emission level of the EUT in peak mode was 3 dB lower than the limit specified, then testing will be stopped and peak values of EUT will be reported, otherwise, the emissions which do not have 3 dB margin will be repeated one by one using the quasi-peak method and reported.

### 5.3. Typical Test Setup

Below 1GHz Test Setup

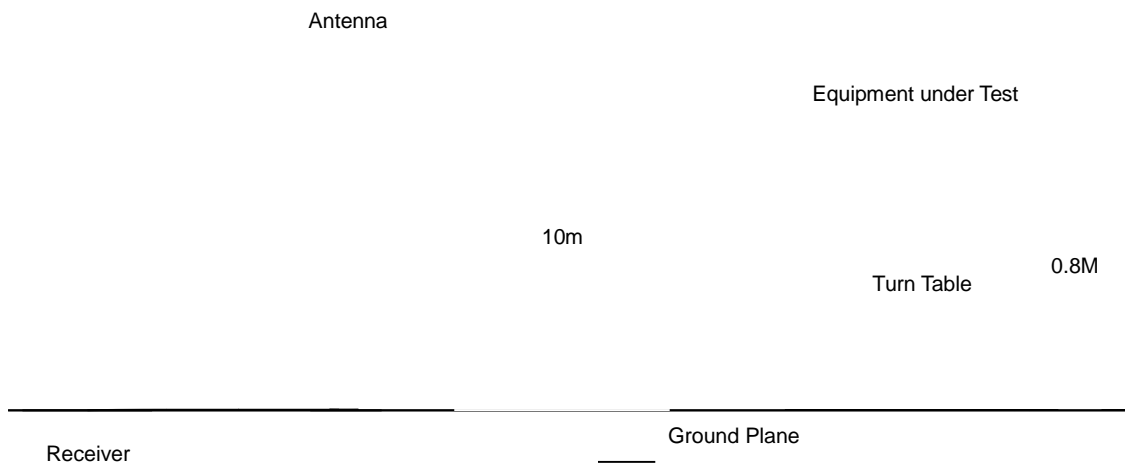

Above 1GHz Test Setup

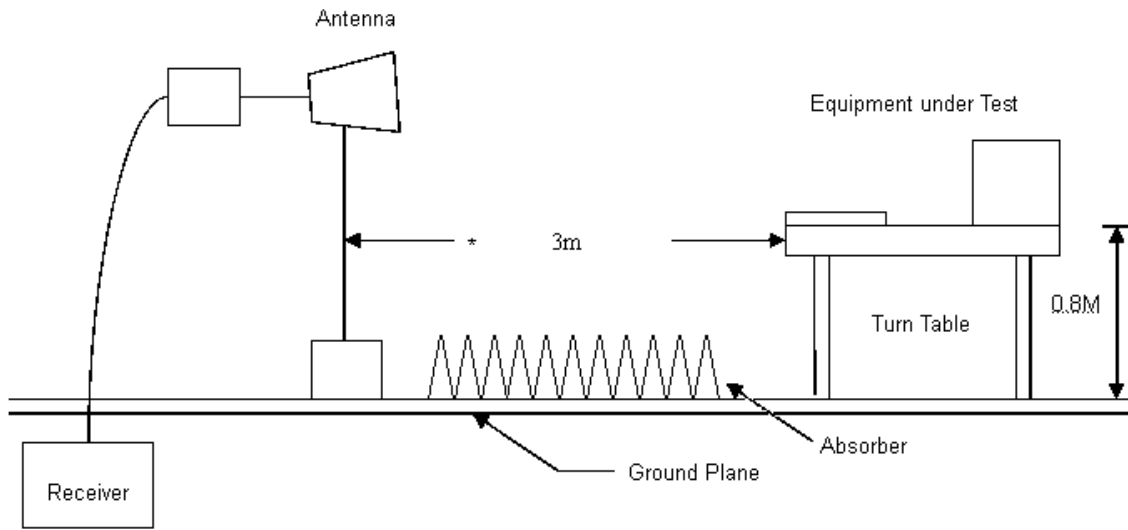

5.4. Measurement Equipment

Instrument	Manufacturer	Model No.	Serial No.	Calibration Date	Valid Date
Bilog Antenna	Sciences Corporation	JB1	A080713	2013/08/22	2014/08/21
Amplifier	AGILENT	8447D	2944A10531	2013/09/24	2014/09/23
EMI Receiver	R&S	ESCI	101200	2013/09/07	2014/09/06
EMI Test Receiver	R&S	ESU 40	13054416-001	2013/09/24	2014/09/23
Amplifier	HP	8449B	13052901-001	2014/01/15	2015/01/14
Double Ridged Antenna	EMCO	3115	43057302-002	2013/04/29	2014/04/28



### 5.5. Test Result and Data (30MHz ~ 1GHz)

Power	: AC 230V	Pol/Phase	: VERTICAL
Test Mode 1	: VGA + HDMI 1080P + LINK LAN (1Gbps), Adapter: LTE60E-S2-1	Temperature	: 26 °C
Test Date	: Mar. 12, 2014	Humidity	: 70 %
Memo	:	Atmospheric Pressure	: 1001 hpa

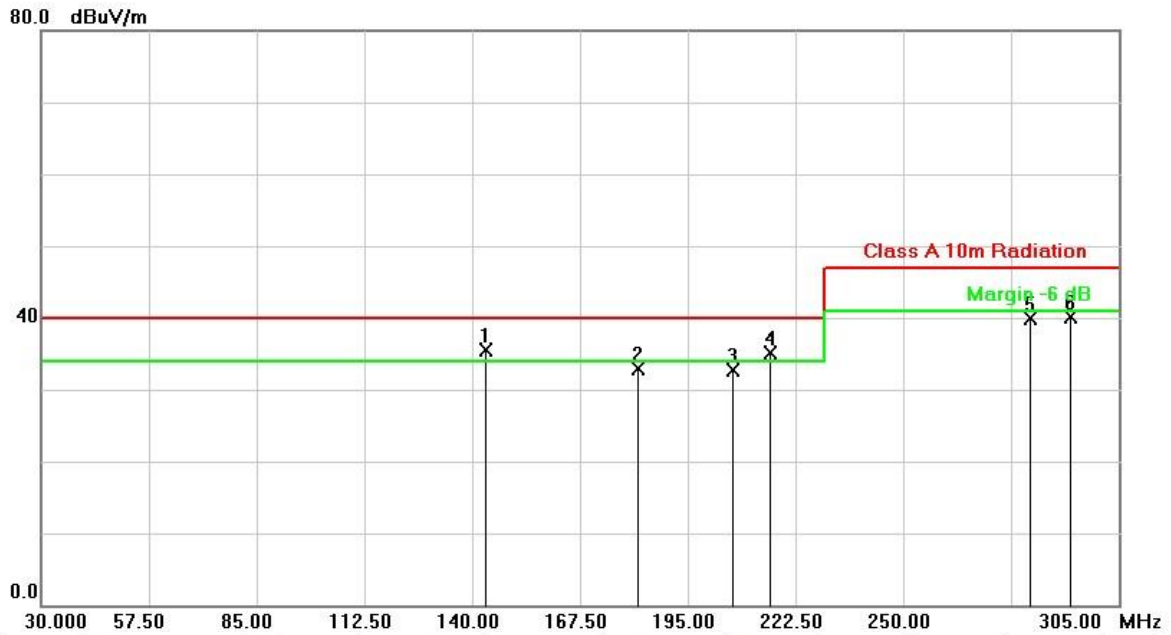

No.	Frequency (MHz)	Factor (dB/m)	Reading (dBuV)	Level (dBuV/m)	Limit (dBuV/m)	Margin (dB)	Detector	Height (cm)	Azimuth (°)	P/F
1	143.3000	-13.85	49.43	35.58	40.00	-4.42	QP	400	0	P
2	182.3497	-14.85	47.75	32.90	40.00	-7.10	QP	400	0	P
3	206.5500	-15.23	47.99	32.76	40.00	-7.24	QP	400	0	P
4	215.9000	-15.44	50.46	35.02	40.00	-4.98	QP	400	0	P
5	282.4499	-12.09	51.93	39.84	47.00	-7.16	QP	400	0	P
6	292.8999	-12.14	52.19	40.05	47.00	-6.95	QP	400	0	P

Note: Level = Reading + Factor  
Margin = Level – Limit  
Factor = Antenna Factor + Cable Loss – Amplifier Factor



Power	: AC 230V	Pol/Phase	: VERTICAL
Test Mode 1	: VGA + HDMI 1080P + LINK LAN (1Gbps), Adapter: LTE60E-S2-1	Temperature	: 26 °C
Test Date	: Mar. 12, 2014	Humidity	: 70 %
Memo	:	Atmospheric Pressure	: 1001 hpa

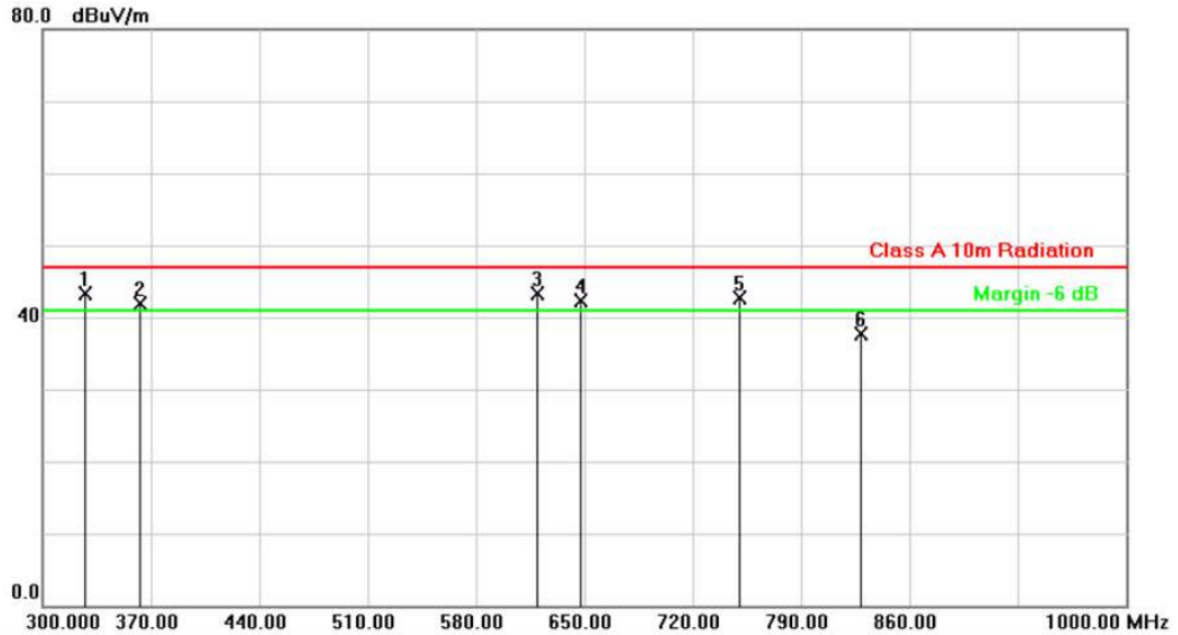

No.	Frequency (MHz)	Factor (dB/m)	Reading (dBuV)	Level (dBuV/m)	Limit (dBuV/m)	Margin (dB)	Detector	Height (cm)	Azimuth (°)	P/F
1	327.3000	-11.56	54.90	43.34	47.00	-3.66	QP	100	0	P
2	363.0000	-10.72	52.57	41.85	47.00	-5.15	QP	100	0	P
3	619.8999	-6.44	49.78	43.34	47.00	-3.66	QP	100	0	P
4	647.8999	-6.03	48.25	42.22	47.00	-4.78	QP	100	0	P
5	750.1000	-4.17	46.80	42.63	47.00	-4.37	QP	100	0	P
6	828.5000	-3.46	41.22	37.76	47.00	-9.24	QP	100	0	P

Note: Level = Reading + Factor  
Margin = Level – Limit  
Factor = Antenna Factor + Cable Loss – Amplifier Factor



Power	: AC 230V	Pol/Phase	: HORIZONTAL
Test Mode 1	: VGA + HDMI 1080P + LINK LAN (1Gbps), Adapter: LTE60E-S2-1	Temperature	: 26 °C
Test Date	: Mar. 12, 2014	Humidity	: 70 %
Memo	:	Atmospheric Pressure	: 1001 hpa

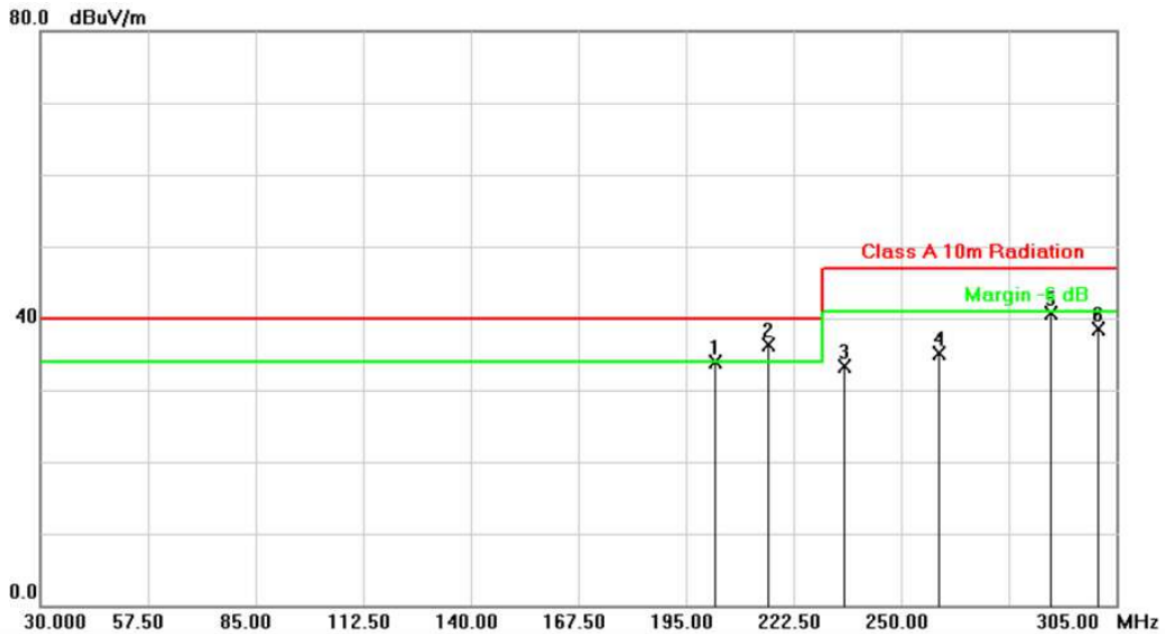

No.	Frequency (MHz)	Factor (dB/m)	Reading (dBuV)	Level (dBuV/m)	Limit (dBuV/m)	Margin (dB)	Detector	Height (cm)	Azimuth (°)	P/F
1	202.6999	-14.24	48.21	33.97	40.00	-6.03	QP	400	0	P
2	216.1750	-15.44	51.83	36.39	40.00	-3.61	QP	400	279	P
3	235.6999	-14.50	47.77	33.27	47.00	-13.73	QP	400	0	P
4	259.6250	-13.43	48.54	35.11	47.00	-11.89	QP	400	0	P
5	288.2250	-12.11	52.80	40.69	47.00	-6.31	QP	400	0	P
6	300.3249	-12.11	50.61	38.50	47.00	-8.50	QP	400	0	P

Note: Level = Reading + Factor  
Margin = Level – Limit  
Factor = Antenna Factor + Cable Loss – Amplifier Factor



Power	: AC 230V	Pol/Phase	: HORIZONTAL
Test Mode 1	: VGA + HDMI 1080P + LINK LAN (1Gbps), Adapter: LTE60E-S2-1	Temperature	: 26 °C
Test Date	: Mar. 12, 2014	Humidity	: 70 %
Memo	:	Atmospheric Pressure	: 1001 hpa

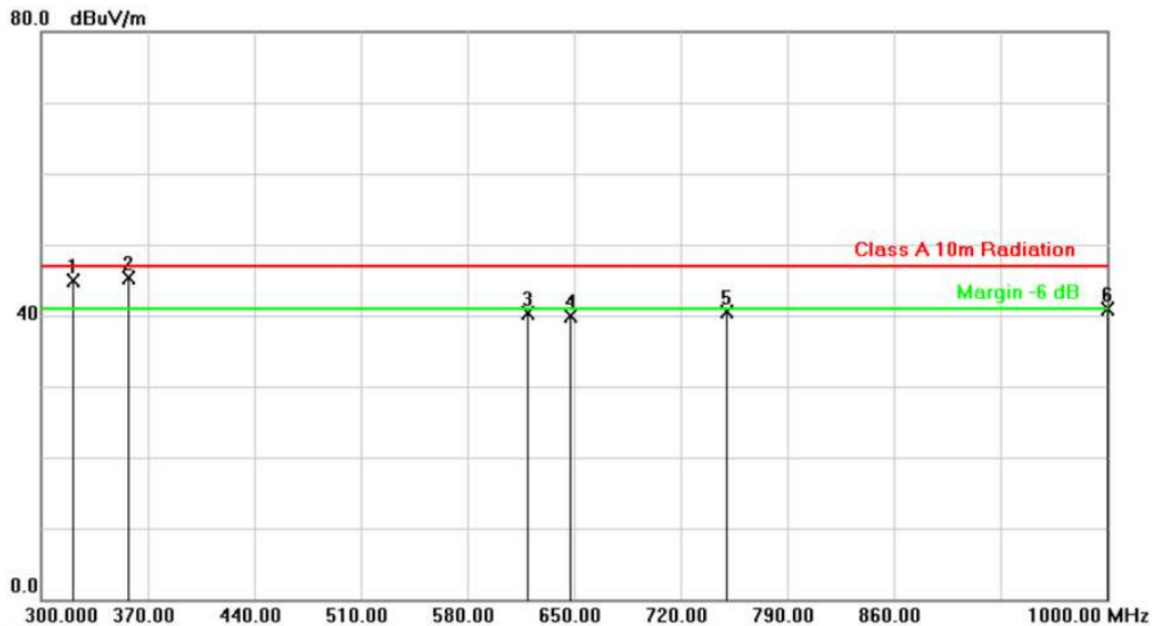

No.	Frequency (MHz)	Factor (dB/m)	Reading (dBuV)	Level (dBuV/m)	Limit (dBuV/m)	Margin (dB)	Detector	Height (cm)	Azimuth (°)	P/F
1	321.0000	-11.65	56.50	44.85	47.00	-2.15	QP	344	256	P
2	357.3999	-10.92	56.28	45.36	47.00	-1.64	QP	185	74	P
3	619.8999	-6.44	46.75	40.31	47.00	-6.69	QP	100	0	P
4	647.8999	-6.03	45.86	39.83	47.00	-7.17	QP	100	0	P
5	750.1000	-4.17	44.76	40.59	47.00	-6.41	QP	100	0	P
6	1000.0000	-0.41	41.22	40.81	47.00	-6.19	QP	100	0	P

Note: Level = Reading + Factor  
Margin = Level – Limit  
Factor = Antenna Factor + Cable Loss – Amplifier Factor





Power	: AC 230V	Pol/Phase	: VERTICAL
Test Mode 2	: VGA + HDMI 1080P + LINK LAN (1Gbps), Adapter: LTE90E-S2-1	Temperature	: 26 °C
Test Date	: Mar. 12, 2014	Humidity	: 70 %
Memo	:	Atmospheric Pressure	: 1001 hpa

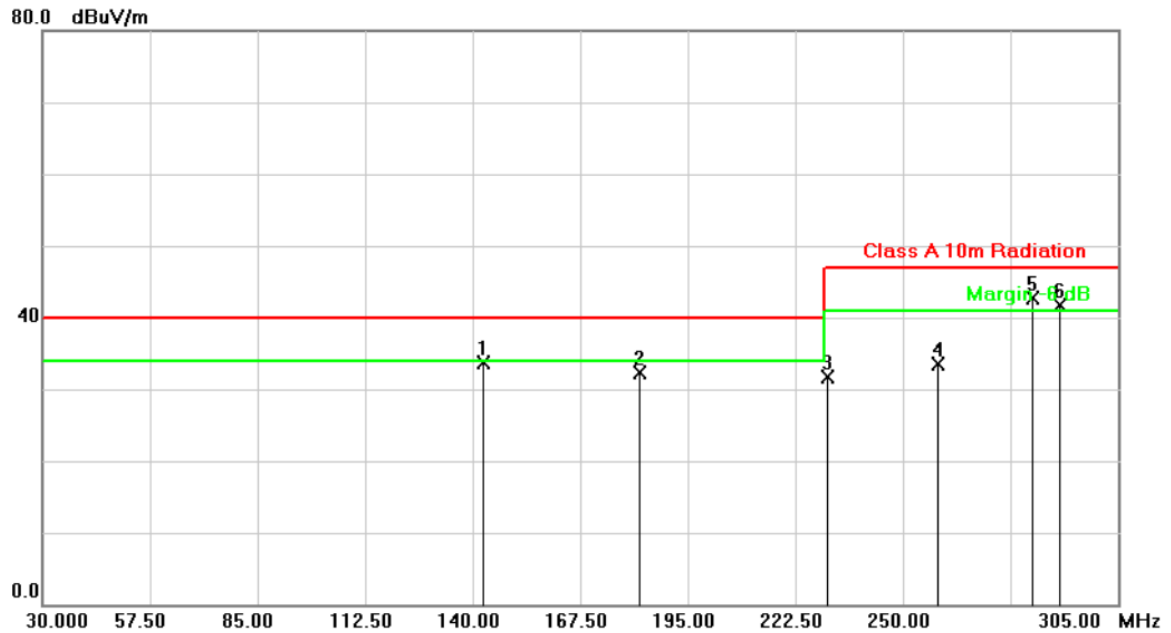

No.	Frequency (MHz)	Factor (dB/m)	Reading (dBuV)	Level (dBuV/m)	Limit (dBuV/m)	Margin (dB)	Detector	Height (cm)	Azimuth (°)	P/F
1	142.7500	-13.81	47.46	33.65	40.00	-6.35	QP	400	0	P
2	182.6250	-14.85	47.14	32.29	40.00	-7.71	QP	400	0	P
3	230.7500	-14.72	46.49	31.77	47.00	-15.23	QP	400	0	P
4	259.0749	-13.51	46.92	33.41	47.00	-13.59	QP	400	0	P
5	283.0000	-12.10	54.71	42.61	47.00	-4.39	QP	400	0	P
6	290.1499	-12.09	53.72	41.63	47.00	-5.37	QP	400	0	P

Note: Level = Reading + Factor  
Margin = Level – Limit  
Factor = Antenna Factor + Cable Loss – Amplifier Factor



Power	: AC 230V	Pol/Phase	: VERTICAL
Test Mode 2	: VGA + HDMI 1080P + LINK LAN (1Gbps), Adapter: LTE90E-S2-1	Temperature	: 26 °C
Test Date	: Mar. 12, 2014	Humidity	: 70 %
Memo	:	Atmospheric Pressure	: 1001 hpa

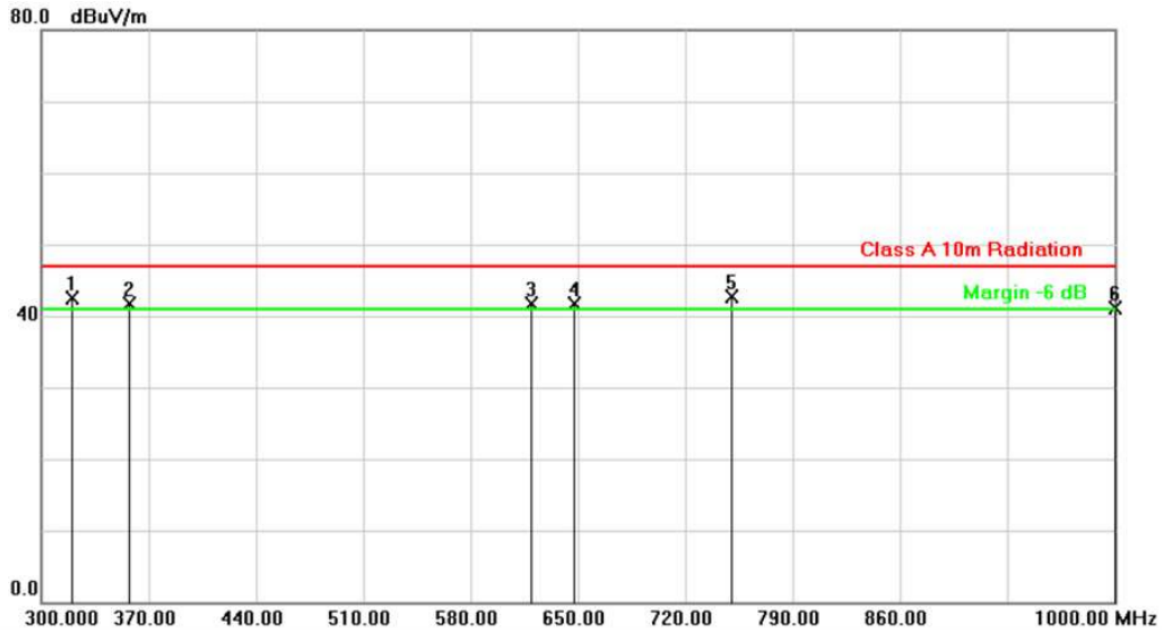

No.	Frequency (MHz)	Factor (dB/m)	Reading (dBuV)	Level (dBuV/m)	Limit (dBuV/m)	Margin (dB)	Detector	Height (cm)	Azimuth (°)	P/F
1	320.3000	-11.67	54.18	42.51	47.00	-4.49	QP	100	0	P
2	357.3999	-10.92	52.71	41.79	47.00	-5.21	QP	100	0	P
3	619.8999	-6.44	48.10	41.66	47.00	-5.34	QP	100	0	P
4	647.8999	-6.03	47.72	41.69	47.00	-5.31	QP	100	0	P
5	750.1000	-4.17	46.80	42.63	47.00	-4.37	QP	100	0	P
6	1000.0000	-0.41	41.46	41.05	47.00	-5.95	QP	100	0	P

Note: Level = Reading + Factor  
Margin = Level – Limit  
Factor = Antenna Factor + Cable Loss – Amplifier Factor



Power	: AC 230V	Pol/Phase	: HORIZONTAL
Test Mode 2	: VGA + HDMI 1080P + LINK LAN (1Gbps), Adapter: LTE90E-S2-1	Temperature	: 26 °C
Test Date	: Mar. 12, 2014	Humidity	: 70 %
Memo	:	Atmospheric Pressure	: 1001 hpa

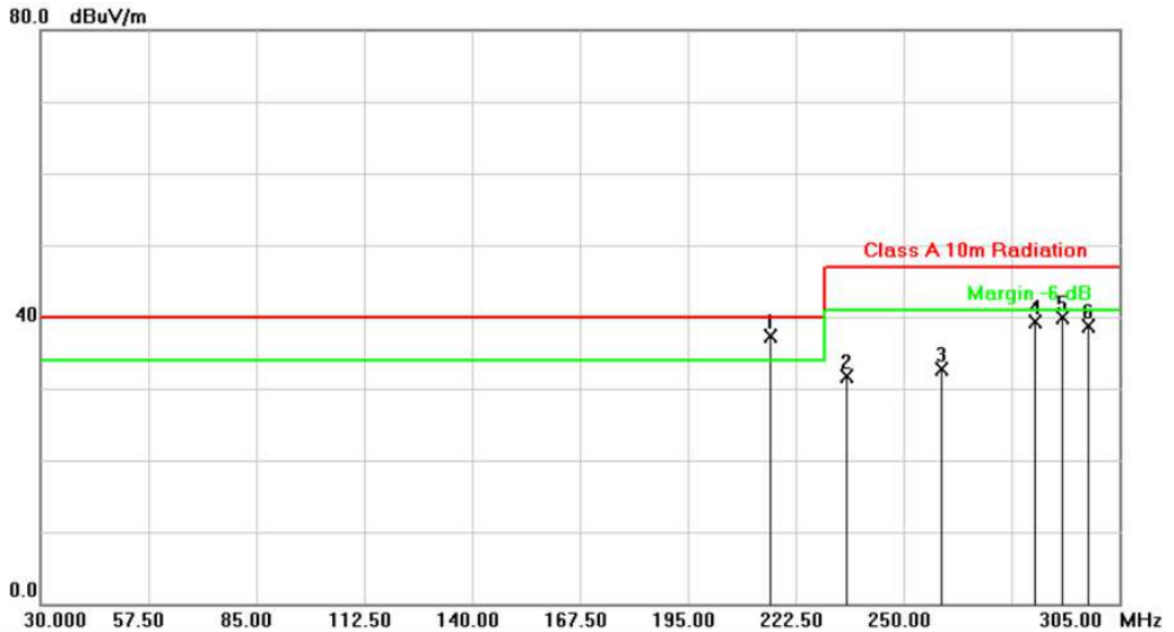

No.	Frequency (MHz)	Factor (dB/m)	Reading (dBuV)	Level (dBuV/m)	Limit (dBuV/m)	Margin (dB)	Detector	Height (cm)	Azimuth (°)	P/F
1	216.1750	-15.44	52.83	37.39	40.00	-2.61	QP	400	266	P
2	235.6999	-14.50	46.27	31.77	47.00	-15.23	QP	400	0	P
3	259.6250	-13.43	46.04	32.61	47.00	-14.39	QP	400	0	P
4	283.5500	-12.11	51.36	39.25	47.00	-7.75	QP	400	0	P
5	290.6999	-12.10	51.98	39.88	47.00	-7.12	QP	400	0	P
6	297.0249	-12.14	50.87	38.73	47.00	-8.27	QP	400	0	P

Note: Level = Reading + Factor  
Margin = Level – Limit  
Factor = Antenna Factor + Cable Loss – Amplifier Factor



Power	: AC 230V	Pol/Phase	: HORIZONTAL
Test Mode 2	: VGA + HDMI 1080P + LINK LAN (1Gbps), Adapter: LTE90E-S2-1	Temperature	: 26 °C
Test Date	: Mar. 12, 2014	Humidity	: 70 %
Memo	:	Atmospheric Pressure	: 1001 hpa

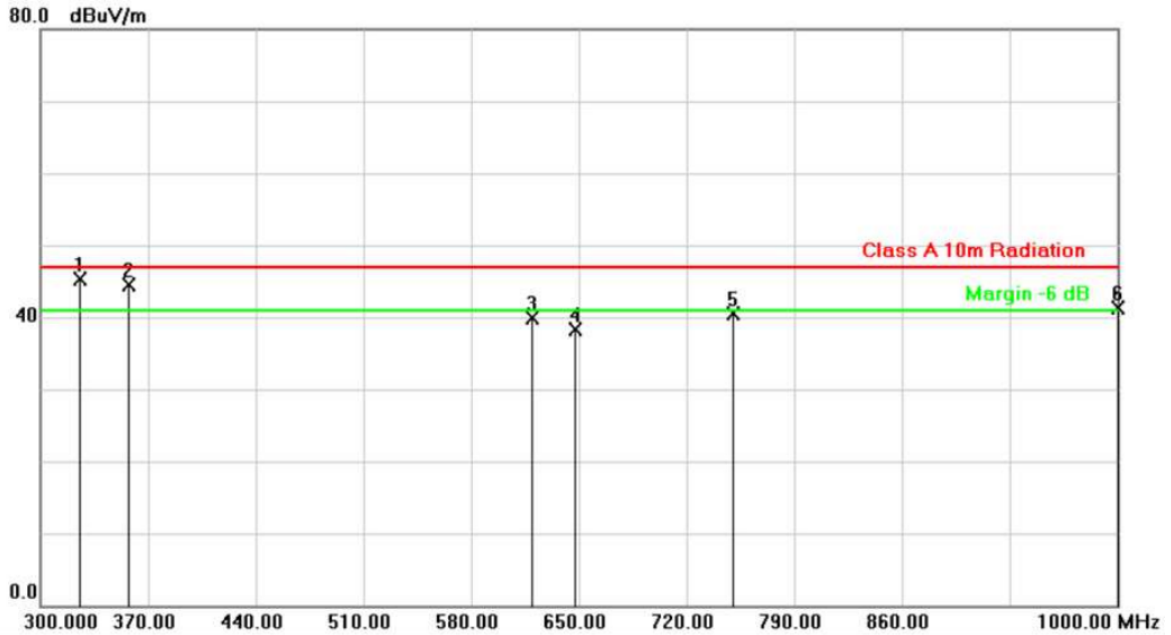

No.	Frequency (MHz)	Factor (dB/m)	Reading (dBuV)	Level (dBuV/m)	Limit (dBuV/m)	Margin (dB)	Detector	Height (cm)	Azimuth (°)	P/F
1	325.8999	-11.53	56.92	45.39	47.00	-1.61	QP	227	360	P
2	357.3999	-10.92	55.44	44.52	47.00	-2.48	QP	139	27	P
3	619.8999	-6.44	46.25	39.81	47.00	-7.19	QP	100	0	P
4	647.8999	-6.03	44.36	38.33	47.00	-8.67	QP	100	0	P
5	750.1000	-4.17	44.76	40.59	47.00	-6.41	QP	100	0	P
6	1000.0000	-0.41	41.72	41.31	47.00	-5.69	QP	100	0	P

Note: Level = Reading + Factor  
 Margin = Level – Limit  
 Factor = Antenna Factor + Cable Loss – Amplifier Factor

Test engineer: Ken



5.6. Test Result and Data (1GHz ~ 6GHz)

Power	: AC 230V	Pol/Phase	: VERTICAL
Test Mode 1	: VGA + HDMI 1080P + LINK LAN (1Gbps), Adapter: LTE60E-S2-1	Temperature	: 24 °C
Test Date	: Mar. 24, 2014	Humidity	: 59 %
Memo	:	Atmospheric Pressure	: 1001 hpa

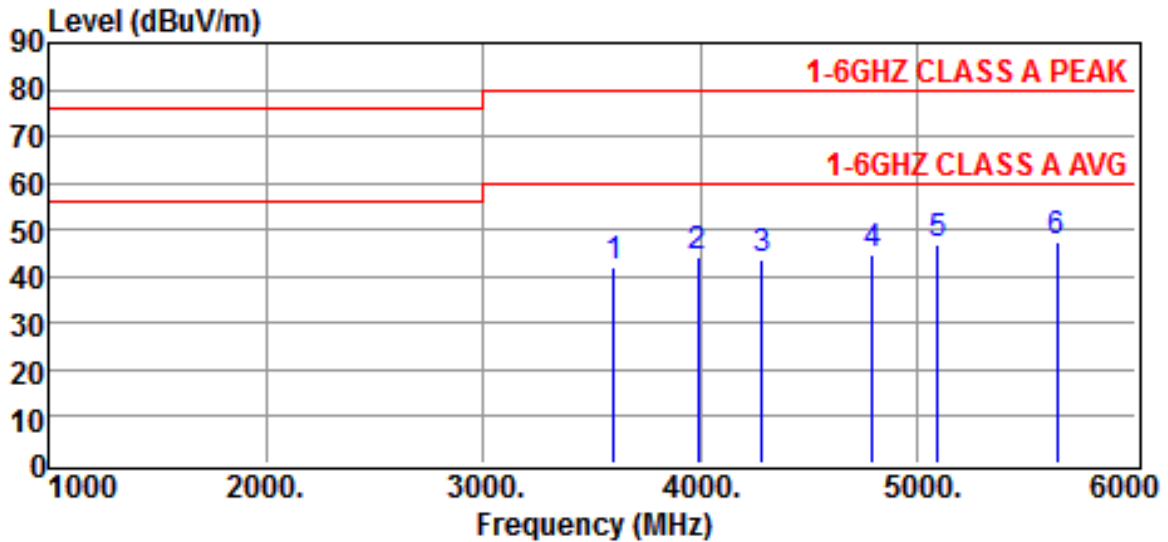

Frequency (MHz)	Reading (dBuV)	Correction Factor (dB)	Result (dBuV/m)	Limits (dBuV/m)	Over limit (dB)	Detector
3600.0000	43.7	-1.5	42.2	80.0	-37.8	Peak
3990.0000	44.2	0.0	44.2	80.0	-35.8	Peak
4280.0000	43.2	0.2	43.4	80.0	-36.6	Peak
4790.0000	43.6	1.3	44.9	80.0	-35.1	Peak
5090.0000	44.8	2.0	46.8	80.0	-33.2	Peak
5640.0000	44.1	3.2	47.3	80.0	-32.7	Peak

Note :

1. Result = Reading + Corrected Factor
2. Corrected Factor = Antenna Factor + Cable Loss - Amplifier Gain (if any)
3. The margin value=Limit - Result



Power	: AC 230V	Pol/Phase	: HORIZONTAL
Test Mode 1	: VGA + HDMI 1080P + LINK LAN (1Gbps), Adapter: LTE60E-S2-1	Temperature	: 24 °C
Test Date	: Mar. 24, 2014	Humidity	: 59 %
Memo	:	Atmospheric Pressure	: 1001 hpa

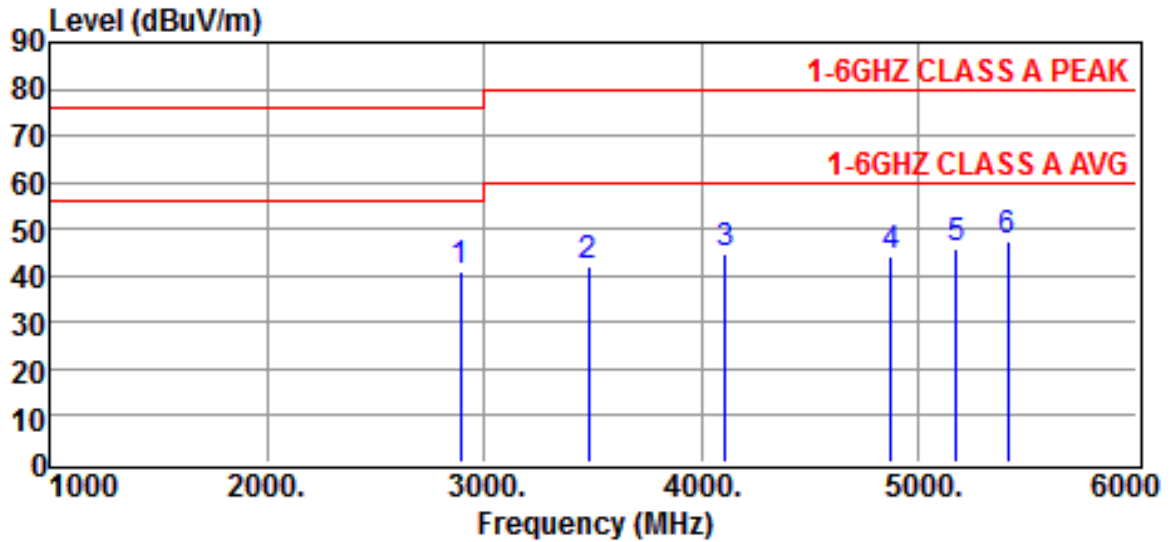

Frequency (MHz)	Reading (dBuV)	Correction Factor (dB)	Result (dBuV/m)	Limits (dBuV/m)	Over limit (dB)	Detector
2890.0000	45.1	-3.9	41.2	76.0	-34.8	Peak
3480.0000	44.0	-1.9	42.1	80.0	-37.9	Peak
4110.0000	44.5	0.2	44.7	80.0	-35.3	Peak
4870.0000	42.9	1.5	44.4	80.0	-35.6	Peak
5170.0000	43.6	2.3	45.9	80.0	-34.1	Peak
5410.0000	45.0	2.7	47.7	80.0	-32.3	Peak

Note :

1. Result = Reading + Corrected Factor
2. Corrected Factor = Antenna Factor + Cable Loss - Amplifier Gain (if any)
3. The margin value=Limit - Result



Power	: AC 230V	Pol/Phase	: VERTICAL
Test Mode 2	: VGA + HDMI 1080P + LINK LAN (1Gbps), Adapter: LTE90E-S2-1	Temperature	: 24 °C
Test Date	: Mar. 24, 2014	Humidity	: 59 %
Memo	:	Atmospheric Pressure	: 1001 hpa

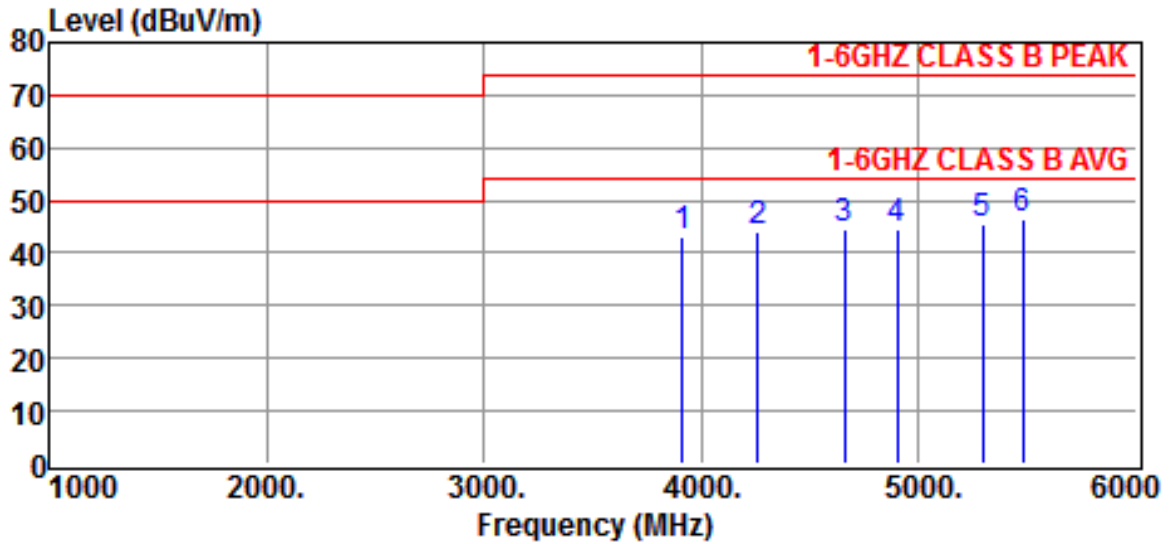

Frequency (MHz)	Reading (dBuV)	Correction Factor (dB)	Result (dBuV/m)	Limits (dBuV/m)	Over limit (dB)	Detector
3910.0000	43.4	-0.2	43.2	74.0	-30.8	Peak
4260.0000	44.1	0.1	44.2	74.0	-29.8	Peak
4660.0000	43.8	0.9	44.7	74.0	-29.3	Peak
4900.0000	42.8	1.5	44.3	74.0	-29.7	Peak
5290.0000	43.1	2.5	45.6	74.0	-28.4	Peak
5480.0000	43.6	3.0	46.6	74.0	-27.4	Peak

Note :

1. Result = Reading + Corrected Factor
2. Corrected Factor = Antenna Factor + Cable Loss - Amplifier Gain (if any)
3. The margin value=Limit - Result



Power	: AC 230V	Pol/Phase	: HORIZONTAL
Test Mode 2	: VGA + HDMI 1080P + LINK LAN (1Gbps), Adapter: LTE90E-S2-1	Temperature	: 24 °C
Test Date	: Mar. 24, 2014	Humidity	: 59 %
Memo	:	Atmospheric Pressure	: 1001 hpa

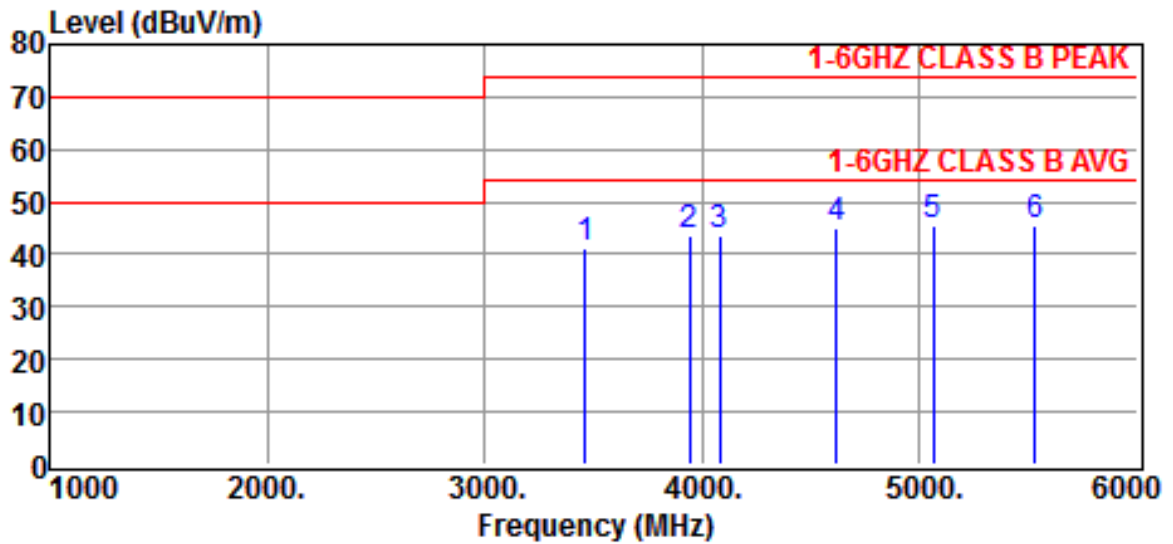

Frequency (MHz)	Reading (dBuV)	Correction Factor (dB)	Result (dBuV/m)	Limits (dBuV/m)	Over limit (dB)	Detector
3460.0000	43.4	-2.0	41.4	74.0	-32.6	Peak
3940.0000	43.5	-0.1	43.4	74.0	-30.6	Peak
4080.0000	43.7	0.1	43.8	74.0	-30.2	Peak
4620.0000	44.4	0.7	45.1	74.0	-28.9	Peak
5060.0000	43.7	2.0	45.7	74.0	-28.3	Peak
5530.0000	42.6	3.0	45.6	74.0	-28.4	Peak

Note :

1. Result = Reading + Corrected Factor
2. Corrected Factor = Antenna Factor + Cable Loss - Amplifier Gain (if any)
3. The margin value=Limit - Result

Test engineer: Ken





### 5.7. Test Photographs (30MHz ~ 1GHz)



Front View

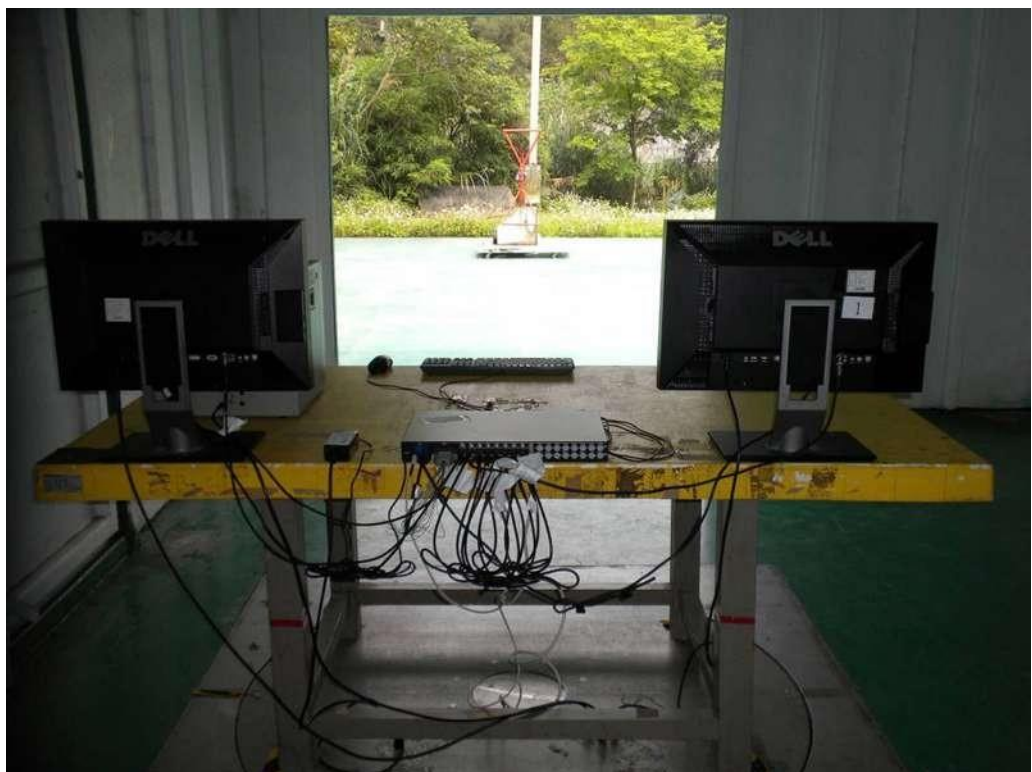

Rear View



### 5.8. Test Photographs (1GHz ~ 6GHz)

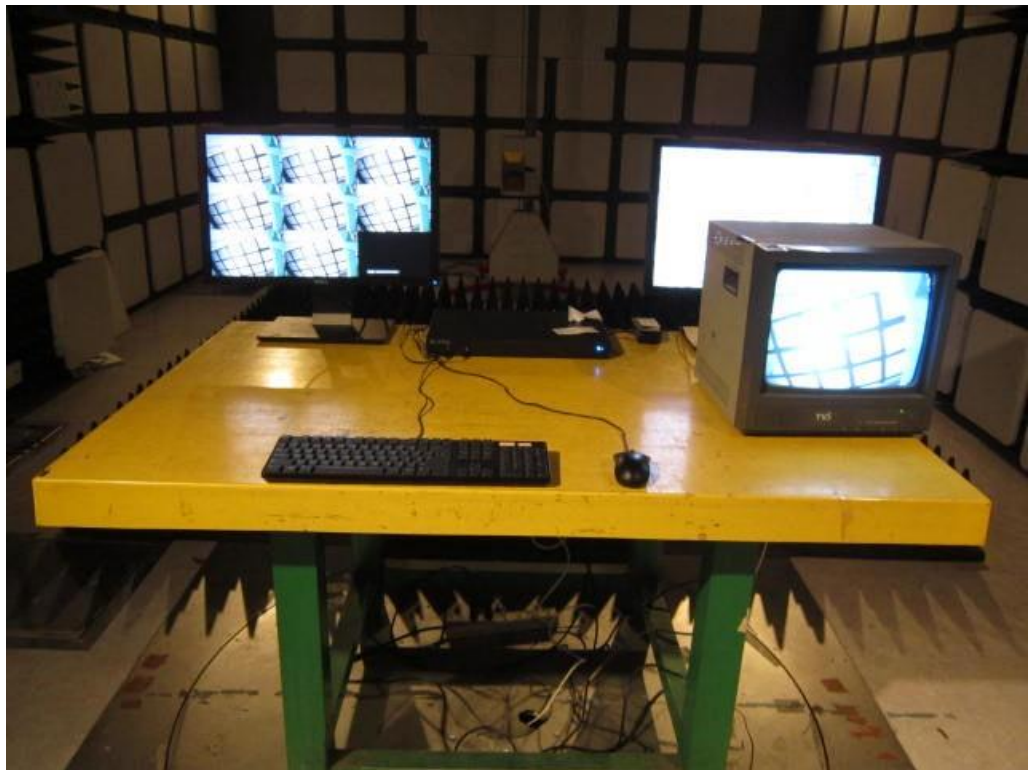

Front View



Rear View



## 6. Harmonics Test

### 6.1. Limits of Harmonics Current Measurement

Limits for Class A equipment		Limits for Class D equipment		
Harmonics Order n	Max. Permissible harmonics current A	Harmonics Order n	Max. Permissible harmonics current per watt mA/W	Max. Permissible harmonics current A
Odd harmonics		Odd Harmonics only		
3	2.30	3	3.4	2.30
5	1.14	5	1.9	1.14
7	0.77	7	1.0	0.77
9	0.40	9	0.5	0.40
11	0.33	11	0.35	0.33
13	0.21	13	0.30	0.21
15<=n<=39	0.15 x 15/n	15<=n<=39	3.85/n	0.15 x 15/n
Even harmonics				
2	1.08			
4	0.43			
6	0.30			
8<=n<=40	0.23 x 8/n			

**NOTE:**

1. Class A and Class D are classified according to item section 5 of EN 61000-3-2:2006+A1:2009+A2:2009.
2. According to section 7 of EN 61000-3-2:2006+A1:2009+A2:2009, the above limits for all equipment except for lighting equipment are for all applications having a rated power > 75 W and no limits apply for equipment with a rated power up to and including 75 W.

### 6.2. Test Result and Data

The limits are not specified for equipment with a rated power of 75W or less. The EUT meets the above condition, so it conforms to EN 61000-3-2.



## 7. Voltage Fluctuations Test

### 7.1. Test Procedure

The equipment shall be tested under the conditions of **Clause 5**.

The total impedance of the test circuit, excluding the appliance under test, but including the internal impedance of the supply source, shall be equal to the reference impedance. The stability and tolerance of the reference impedance shall be adequate to ensure that the overall accuracy of  $\pm 8\%$  is achieved during the whole assessment procedure.

### 7.2. Measurement Equipment

Instrument	Manufacturer	Model No.	Serial No.	Calibration Date	Valid Date
Power & Harmonics Analyzer	TTI	HA1600	198226	2013/09/13	2014/09/12



### 7.3. Test Result and Data

Final Test Result	: PASS	Basic Standard	: EN 61000-3-3
Temperature	: 25 °C	Relative Humidity	: 46 %
Test Data	: Mar. 20, 2014	Test Mode	: Mode 1

Supply Voltage:	234.1 Vrms	330.9 Vpk	Frequency: 50.01 Hz
	THD: 0.8%	Crest Factor: 1.414	peak at: 97.3 deg

Load Power:	0.020 kW	0.051 kVA	Power Factor: 0.446
-------------	----------	-----------	---------------------

Load Current:	0.20 to 0.21 Arms	0.88 Apk	Crest Factor: 4.165
---------------	-------------------	----------	---------------------

#### Voltage Variations

Highest Half-cycle level:	+1.87%		
Lowest Half-cycle level:	+1.68%		
d(max):	0.19%		Pass

Number of Change Intervals:	1		
Highest d(t) for 500 ms:	0.00%		Pass
Longest d(t) over 3.30%:	0.00 seconds		

'Steady State' definition:	>1000 ms below	0.32%	
Highest Steady State level:	1.78%		
Lowest Steady State level:	1.78%		
max d(c) between adjacent:	0.00%		Pass
max d(c) between any:	0.00%		

#### Flicker

Long-term Flicker indicator Plt :	0.00
-----------------------------------	------

Short-term Flicker indicator Pst :	
------------------------------------	--

Plt Interval	Pst
1:	0.02
2:	0.02
3:	0.02
4:	0.02
5:	0.00
6:	0.02
7:	0.00
8:	0.00
9:	0.00
10:	0.00
11:	0.00
12:	0.00

Pst classifier:	Duration	Flicker
	0.1%	0.00
	0.7%	0.00
	1.0%	0.00
	1.5%	0.00
	2.2%	0.00
	3%	0.00
	4%	0.00
	6%	0.00
	8%	0.00
	10%	0.00
	13%	0.00
	17%	0.00
	30%	0.00
	50%	0.00
	80%	0.00



Final Test Result : **PASS** Basic Standard : EN 61000-3-3  
 Temperature : 25 °C Relative Humidity : 46 %  
 Test Data : Mar. 20, 2014 Test Mode : Mode 2

Supply Voltage: 234.0 to 234.1 Vrms 330.7 Vpk Frequency: 50.00 Hz  
 THD: 0.8% Crest Factor: 1.413 peak at: 94.4 deg  
 Load Power: 0.020 kW 0.051 kVA Power Factor: 0.461  
 Load Current: 0.19 to 0.21 Arms 0.88 Apk Crest Factor: 4.158

Voltage Variations

Highest Half-cycle level: +1.90%  
 Lowest Half-cycle level: +1.67%  
 d(max): 0.23% Pass

Number of Change Intervals: 1  
 Highest d(t) for 500 ms: 0.00% Pass  
 Longest d(t) over 3.30%: 0.00 seconds

~Steady State' definition: >1000 ms below 0.32%  
 Highest Steady State level: 1.76%  
 Lowest Steady State level: 1.76%  
 max d(c) between adjacent: 0.00% Pass  
 max d(c) between any: 0.00%

Flicker

Long-term Flicker indicator Plt : 0.00  
 Short-term Flicker indicator Pst :

Plt Interval	Pst
1:	0.02
2:	0.02
3:	0.02
4:	0.00
5:	0.02
6:	0.02
7:	0.00
8:	0.02
9:	0.00
10:	0.00
11:	0.02
12:	0.02

Pst classifier:	Duration	Flicker
	0.1%	0.01
	0.7%	0.00
	1.0%	0.00
	1.5%	0.00
	2.2%	0.00
	3%	0.00
	4%	0.00
	6%	0.00
	8%	0.00
	10%	0.00
	13%	0.00
	17%	0.00
	30%	0.00
	50%	0.00
	80%	0.00

Test engineer: Dora



### 7.4. Test Photographs





## 8. Electrostatic Discharge Immunity Test

### 8.1. Test Procedure

- a. In the case of air discharge testing the climatic conditions shall be within the following ranges:
  - ambient temperature: 15°C to 35°C;
  - relative humidity : 30% to 60%;
  - atmospheric pressure : 86 KPa (860 mbar) to 106 KPa (1060 mbar).
- b. Test programs and software shall be chosen so as to exercise all normal modes of operation of the EUT. The use of special exercising software is encouraged, but permitted only where it can be shown that the EUT is being comprehensively exercised.
- c. The test voltage shall be increased from the minimum to the selected test severity level, in order to determine any threshold of failure. The final severity level should not exceed the product specification value in order to avoid damage to the equipment.
- d. The test shall be performed with both air discharge and contact discharge. On reselected points at least 10 single discharges (in the most sensitive polarity) shall be applied on air discharge. On reselected points at least 10 single discharges (in the most sensitive polarity) shall be applied on contact discharge.
- e. For the time interval between successive single discharges an initial value of one second is recommended. Longer intervals may be necessary to determine whether a system failure has occurred.
- f. In the case of contact discharges, the tip of the discharge electrode shall touch the EUT before the discharge switch is operated.
- g. In the case of painted surface covering a conducting substrate, the following procedure shall be adopted :
  - If the coating is not declared to be an insulating coating by the equipment manufacturer, then the pointed tip of the generator shall penetrate the coating so as to make contact with the conducting substrate.
  - Coating declared as insulating by the manufacturer shall only be submitted to the air discharge.
  - The contact discharge test shall not be applied to such surfaces.
- h. In the case of air discharges, the round discharge tip of the discharge electrode shall be approached as fast as possible (without causing mechanical damage) to touch the EUT . After each discharge, the ESD generator (discharge electrode) shall be removed from the EUT. The generator is then retriggered for a new single discharge. This procedure shall be repeated until the discharges are completed. In the case of an air discharge test, the discharge switch, which is used for contact discharge, shall be closed.



## 8.2. Test Setup for Tests Performed in Laboratory

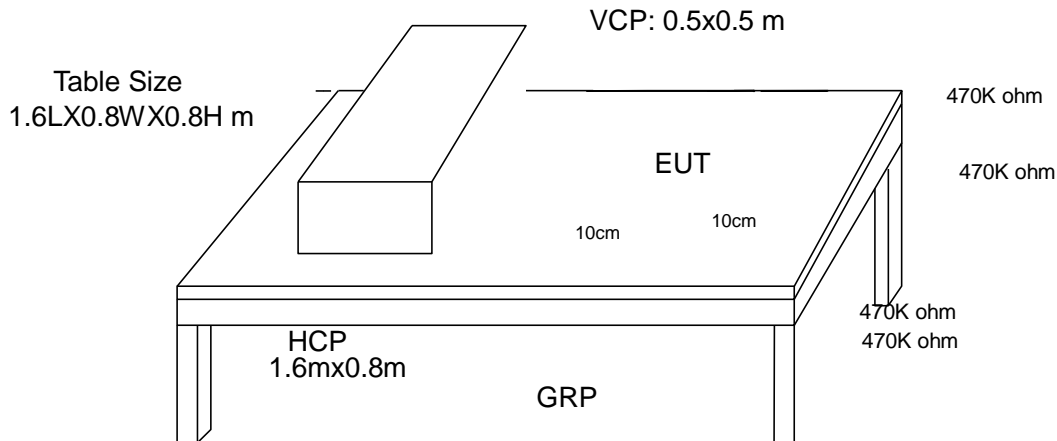

The test setup consists of the test generator, EUT and auxiliary instrumentation necessary to perform DIRECT and INDIRECT application of discharges to the EUT as applicable, in the follow manner :

- a. Contact Discharge to the conductive surfaces and to coupling plane;
- b. Air Discharge at insulating surfaces.

The preferred test method is that of type tests performed in laboratories and the only accepted method of demonstrating conformance with this standard. The EUT was arranged as closely as possible to arrangement in final installed conditions.

A ground reference plane was provided on the floor of the test site. It was a metallic sheet (copper or aluminum) of 0.25 mm, minimum thickness; other metallic may be used but they shall have at least 0.65 mm thickness. In the CerpPASS Technology Corp., we provided 1 mm thickness stainless steel ground reference plane. The minimum size of the ground reference plane is 2.5 m x 2.5 m, the exact size depending on the dimensions of the EUT. It was connected to the protective grounding system.

The EUT was arranged and connected according to its functional requirements. A distance of 1m minimum was provided between the EUT and the wall of the lab. and any other metallic structure. In cases where this length exceeds the length necessary to apply the discharges to the selected points, the excess length shall, where possible, be placed non-inductively off the ground reference plane and shall not come closer than 0.2m to other conductive parts in the test setup.

Where the EUT is installed on a metal table, the table was connected to the reference plane via a cable with a 470k ohm resistor located at each end, to prevent a build-up of charge. The test setup was consist a wooden table, 0.8m high, standing on the ground reference plane. A HCP, 1.6 m x 0.8 m, was placed on the table. The EUT and cables was isolated from the HCP by an insulating support 0.5 mm thick. The VCP size, 0.5 m x 0.5 m.



### 8.3. Test Severity Levels

Contact Discharge		Air Discharge	
Level	Test Voltage (KV) of Contact discharge	Level	Test Voltage (KV) of Air Discharge
1	±2	1	±2
2	±4	2	±4
3	±6	3	±8
4	±8	4	±15
X	Specified	X	Specified

Remark: "X" is an open level.

### 8.4. Measurement Equipment

Instrument	Manufacturer	Model No.	Serial No.	Calibration Date	Valid Date
ESD SIMULATOR	Schaffner	NSG438	878	2013/03/29	2014/03/28



8.5. Test Result and Data

Final Test Result : **PASS**  
 Basic Standard : IEC 61000-4-2  
 Product Standard : EN 50130-4  
 Test Voltage : ±2 / ±4 / ±8 KV for air discharge,  
 : ±2 / ±4 / ±6 KV for contact discharge  
 Temperature : 27°C  
 Relative Humidity : 51 %  
 Atmospheric Pressure : 1016 hPa  
 Test Date : Mar. 19, 2014

Test Mode: Mode 1 & Mode 2

	Contact Discharge						Air Discharge					
	10 times / each						10 times / each					
Voltage	2 KV		4 KV		6 KV		2 KV		4 KV		8 KV	
Point\Polarity	+	-	+	-	+	-	+	-	+	-	+	-
HCP	A	A	A	A	A	A	---	---	---	---	---	---
VCP	A	A	A	A	A	A	---	---	---	---	---	---
Case	A	A	A	A	A	A	---	---	---	---	---	---
Screw	A	A	A	A	A	A	---	---	---	---	---	---
DC Jack	---	---	---	---	---	---	A	A	A	A	A	A
RJ45	A	A	A	A	A	A	---	---	---	---	---	---
BNC Port	A	A	A	A	A	A	---	---	---	---	---	---
USB Port	---	---	---	---	---	---	A	A	A	A	A	A
D-SUB Port	A	A	A	A	A	A	---	---	---	---	---	---
HDMI Port	A	A	A	A	A	A	---	---	---	---	---	---
LED	---	---	---	---	---	---	A	A	A	A	A	A

Note: "A" normal performance within limits specified by the manufacturer, requestor or purchaser.

Test engineer: Dora



### 8.6. Test Photographs





## 9. Radio Frequency electromagnetic field immunity test

### 9.1. Test Procedure

- The equipment to be tested is placed in the center of the enclosure on a wooden table. The equipment is then connected to power and signal leads according to pertinent installation instructions.
- The antenna which is enabling the complete frequency range of 80-2700 MHz is placed 3m away from the equipment. The required field strength is determined by placing the field strength meter(s) on top of or directly alongside the equipment under test and monitoring the field strength meter via a remote field strength indicator outside the enclosure while adjusting the continuous-wave to the applicable antennae.
- The test is normally performed with the antenna facing the most sensitive side of the EUT. The polarization of the field generated by the bucolical antenna necessitates testing each position twice, once with the antenna positioned vertically and again with the antenna positioned horizontally. The circular polarization of the field from the log-spiral antenna makes a change of position of the antenna unnecessary.
- At each of the above conditions, the frequency range is swept 80-2700 MHz, pausing to adjust the R.F. signal level or to switch oscillators and antenna. The rate of sweep is in the order of  $1.5 \times 10^{-3}$  decades/s. The sensitive frequencies or frequencies of dominant interest may be discretely analyzed.

### 9.2. Test Severity Levels

Frequency Band : 80-2700 MHz	
Level	Test field strength (V/m)
1	1
2	3
3	10
X	Specified
Remark: "X" is an open class.	

### 9.3. Measurement Equipment

Instrument	Manufacturer	Model No.	Serial No.	Calibration Date	Valid Date
Amplifiers 80-1000MHz/100W	SCHAFFNER	CBA9413B	43510	N/A	N/A
Amplifiers 80-3000MHz/20W	SCHAFFNER	CBA9428	43515	N/A	N/A
Antenna	SCHAFFNER	CBL6141A	4257	N/A	N/A
Power Meter	Boonton	4231A-01	115902	2013/09/14	2014/09/13
Field Probe	HOLADAY	HI-6105	00144727	2013/09/19	2014/09/18
Signal Generator	HP	8648C	3629U00612	2013/09/11	2014/09/10
Power Sensor	Boonton	51011-EMC	33312	2013/09/14	2014/09/13



9.4. Test Result and Data

Final Test Result : **PASS**  
 Basic Standard : IEC 61000-4-3  
 Product Standard : EN 50130-4  
 Frequency Range : 80~2700 MHz  
 Temperature : 25 °C  
 Relative Humidity : 56 %  
 Atmospheric Pressure : 1016 hPa  
 Test Date : Mar. 20, 2014

Test Mode: Mode 1 & Mode 2

Modulation : AM 80% , 1KHz sine wave, Dwell time: 3 S Frequency Step Size : 1 % of preceding frequency value				
Frequency (MHz)	Antenna Polarization	face	Field strength (V/m)	Result
80~2700	Vertical	Front	10 V/m	A
80~2700	Vertical	Rear	10 V/m	A
80~2700	Vertical	Left	10 V/m	A
80~2700	Vertical	Right	10 V/m	A
80~2700	Horizontal	Front	10 V/m	A
80~2700	Horizontal	Rear	10 V/m	A
80~2700	Horizontal	Left	10 V/m	A
80~2700	Horizontal	Right	10 V/m	A

Note: " A " normal performance within limits specified by the manufacturer, requestor or purchaser.

Test engineer: Dora



### 9.5. Test Photographs

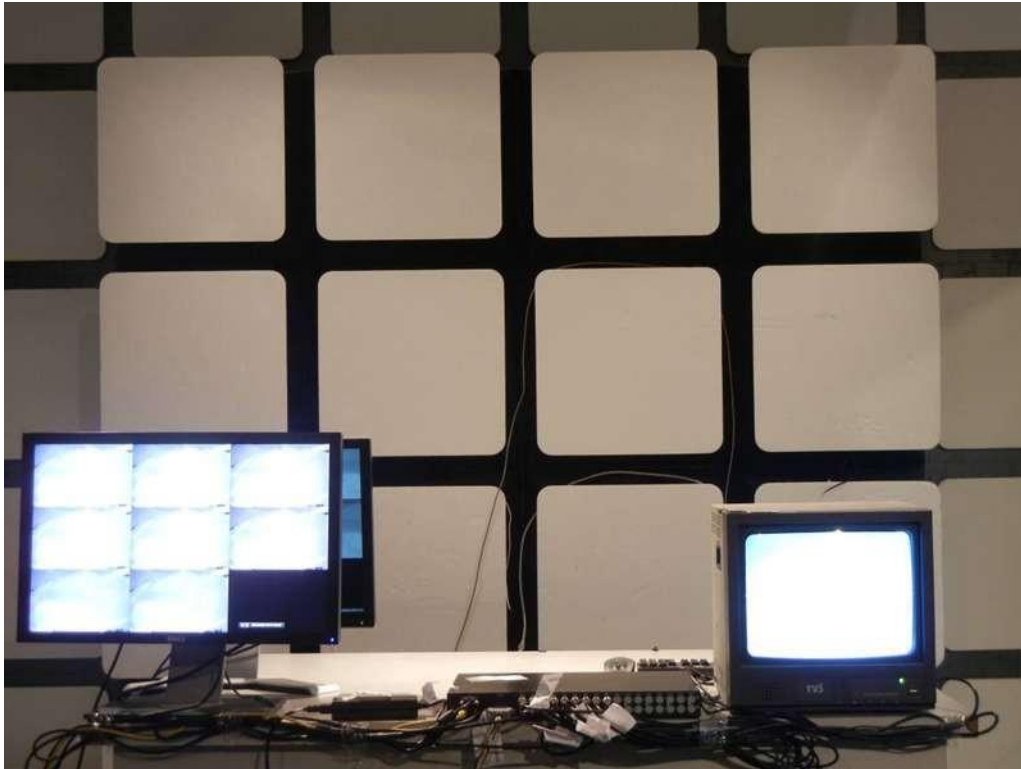



## 10. Electrical Fast Transient/ Burst Immunity Test

### 10.1. Test Procedure

- a. In order to minimize the effect of environmental parameters on test results, the climatic conditions when test is carrying out shall comply with the following requirements:
  - ambient temperature: 15°C to 35°C;
  - relative humidity : 45% to 75%;
  - Atmospheric pressure: 86 Kpa (860 mbar) to 106 Kpa (1060 mbar).
- b. In order to minimize the effect of environmental parameters on test results, the electromagnetic environment of the laboratory shall not influence the test results.
- c. The variety and diversity of equipment and systems to be tested make it difficult to establish general criteria for the evaluation of the effects of fast transients/bursts on equipment and systems.
- d. Test on Power Line:
  - The EFT/B-generator was located on the GRP.  
For floor standing equipment 1,0 m  
For table top equipment 0,5 m
  - The EFT/B-generator provides the ability to apply the test voltage in a non-symmetrical condition to the power supply input terminals of the EUT.
- e. Test on Communication Lines
  - The coupling clamp is composed of a clamp unit for housing the cable (length more than 3 m), and was placed on the GRP.
  - The coupling clamp provides the ability of coupling the fast transient/bursts to the cable under test.
- f. The test results may be classified on the basic of the operating conditions and the functional specification of the equipment under test, according to the following performance criteria :
  - Normal performance within the specification limits.
  - Temporary degradation or loss of function or performance which is self-recoverable.
  - Temporary degradation or loss of function or performance which requires operator intervention or system reset.
  - Degradation or loss of function which is not recoverable due to damage of equipment (components).

### 10.2. Test Severity Levels

The following test severity levels are recommended for the fast transient/burst test :

Open circuit output test voltage $\pm 10\%$		
Level	On Power Supply	On I/O signal, data and control line
1	0.5 KV	0.25 KV
2	1.0 KV	0.50 KV
3	2.0 KV	1.00 KV
4	4.0 KV	2.00 KV
X	Specified	Specified

Remark : " X " is an open level. The level is subject to negotiation between the user and manufacturer or is specified by the manufacturer.

### 10.3. Measurement Equipment

Instrument	Manufacturer	Model No.	Serial No.	Calibration Date	Valid Date
TESQ NSG3060	TESQ	NSG3060	1385	2013/04/11	2014/04/10





10.4. Test Result and Data

Final Test Result : **PASS**  
 Basic Standard : IEC 61000-4-4  
 Product Standard : EN 50130-4  
 Test Voltage : On AC Port --  $\pm 0.5$  KV,  $\pm 1.0$  KV,  $\pm 2.0$  KV  
                   : On Signal Port --  $\pm 0.5$  KV,  $\pm 1.0$  KV  
 Temperature : 25 °C  
 Relative Humidity : 56 %  
 Atmospheric Pressure : 1016 hPa  
 Test Date : Mar. 19, 2014

Test Mode: Mode 1 & Mode 2

Pulse : 5/50 ns		Repetition Rate: <u>100 kHz</u>					
Burst : 0.75m/300ms		Test time : 1 min/each condition					
Voltage/ Mode/ Polarity/ Result/ Phase		0.5 kV		1.0 kV		2.0 kV	
		+	-	+	-	+	-
Power Line	L	A	A	A	A	A	A
	N	A	A	A	A	A	A
	L-N	A	A	A	A	A	A
	PE	A	A	A	A	A	A
	L-PE	A	A	A	A	A	A
	N-PE	A	A	A	A	A	A
	L-N-PE	A	A	A	A	A	A
Signal Line	RJ45 (10M/100M/1Gbps)	A	A	A	A	---	---
	BNC	A	A	A	A	---	---

Note: "A" normal performance within limits specified by the manufacturer, requestor or purchaser.

Test engineer:                   Dosa



### 10.5. Test Photographs



Power Line



Clamp



## 11. Surge Immunity Test

### 11.1. Test Procedure

- a. Climatic conditions  
The climatic conditions shall comply with the following requirements :
  - ambient temperature : 15 °C to 35 °C
  - relative humidity : 10 % to 75 %
  - atmospheric pressure : 86 kPa to 106 kPa ( 860 mbar to 1060 mbar )
- b. Electromagnetic conditions  
the electromagnetic environment of the laboratory shall not influence the test results.
- c. The test shall be performed according the test plan that shall specify the test set-up with
  - generator and other equipment utilized;
  - test level ( voltage/current );
  - generator source impedance;
  - internal or external generator trigger;
  - number of tests : at least five positive and five negative at the selected points;
  - repetition rate : maximum 1/min.
  - inputs and outputs to be tested;
  - representative operating conditions of the EUT;
  - sequence of application of the surge to the circuit;
  - phase angle in the case of AC. power supply;
  - actual installation conditions, for example :
    - AC : neutral earthed,
    - DC : ( + ) or ( - ) earthed to simulated the actual earthing conditions.
- d. If not otherwise specified the surges have to be applied synchronized to the voltage phase at the zero-crossing and the peak value of the AC. voltage wave ( positive and negative ).
- e. The surges have to be applied line to line and line(s) and earth. When testing line to earth, the test voltage has to be applied successively between each of the lines and earth, if there is no other specification.
- f. The test procedure shall also consider the non-linear current-voltage characteristics of the equipment under test. Therefore the test voltage has to be increased by steps up to the test level specified in the product standard or test plan.
- g. All lower levels including the selected test level shall be satisfied. For testing the secondary protection, the output voltage of the generator shall be increased up to the worst-case voltage breakdown level ( let-through level ) of the primary protection.
- h. If the actual operating signal sources are not available, that may be simulated. Under no circumstances may the test level exceed the product specification. The test shall be carried out according to a test plan.
- i. To find all critical points of the duty cycle of the equipment, a sufficient number of positive and negative test pulses shall be applied. For acceptance test previously unstressed equipment shall be used to the protection devices shall be replaced.

### 11.2. Test Severity Level

Level	Open-circuit test voltage, ± 10%, KV
1	0.5
2	1.0
3	2.0
4	4.0
X	Specified

NOTE: "X" is an open class. This level can be specified in the product specification.



### 11.3. Measurement Equipment

Instrument	Manufacturer	Model No.	Serial No.	Calibration Date	Valid Date
TESQ NSG3060	TESQ	NSG3060	1385	2013/04/11	2014/04/10

### 11.4. Test Result and Data

Final Test Result : **PASS**  
Basic Standard : IEC 61000-4-5  
Product Standard : EN 50130-4  
Test Voltage : Input AC Power Port --  $\pm 0.5$  kV,  $\pm 1.0$  kV,  $\pm 2.0$  kV  
Signal Port --  $\pm 1.0$  kV  
Temperature : 25°C  
Relative Humidity : 56 %  
Atmospheric Pressure : 1016 hPa  
Test Date : Mar. 19, 2014

#### Power Port

Waveform : 1.2/50 $\mu$ s(8/20 $\mu$ s)    Repetition rate : 60 sec    Time : 5 time/each condition						
Phase Voltage / Mode / Polarity / Result			0°	90°	180°	270°
0.5 kV, 1.0kV	L-N	+	A	A	A	A
		-	A	A	A	A
0.5 kV, 1.0kV, 2.0kV	L-PE	+	A	A	A	A
		-	A	A	A	A
	N-PE	+	A	A	A	A
		-	A	A	A	A

Note: "A" normal performance within limits specified by the manufacturer, requestor or purchaser.

#### Signal Port

**BNC & Alarm** Where Normal functioning cannot be achieved because of the impact of the CDN on the EUT.

Waveform : 1.2/50 $\mu$ s(8/20 $\mu$ s), Repetition rate : 60 sec, Time : 5 time/each condition			
Phase Voltage / Mode / Polarity / Result			
0.5kV, 1.0kV	RJ45 L-PE, BNC L-PE, Alarm L-PE	+	A
		-	A

Note: "A" normal performance within limits specified by the manufacturer, requestor or purchaser.

Test engineer: Dora



### 11.5. Test Photographs



Power Port



Signal Port  
(RJ45)



Signal Port  
(BNC &  
Alarm)





## 12. Conduction Disturbances induced by Radio-Frequency Fields

### 12.1. Test Procedure

- a. The EUT shall be operated within its intended climatic conditions. The temperature and relative humidity should be recorded.
- b. This test method test can be performed without using a sell shielded enclosure. This is because the disturbance levels applied and the geometry of the setups are not likely to radiated a high amount of energy, especially at the lower frequencies. If under certain circumstances the radiated energy is too high, a shielded enclosure has to be used.
- c. The test shall be performed with the test generator connected to each of the coupling and decoupling devices in turn while the other non-excited RF-input ports of the coupling devices are terminated by a 50 ohm load resistor.
- d. The frequency range is swept from 150 KHz to 100 MHz, using the signal levels established during the setting process, and with the disturbance signal 80% amplitude modulated with a 1KHz sign wave, pausing to adjust the RF-signal level or to switch coupling devices as necessary. The rate of sweep shall no exceed  $1.5 \times 10^{-3}$  decades/s. Where the frequency is swept incrementally, the step size shall no exceed 1% of the start and thereafter 1% of the preceding frequency value.
- e. The dwell time at each frequency shall not be less than the time necessary for the EUT to be exercised, and able to respond. Sensitive frequencies e.g. clock frequency (ies) and harmonics or frequencies of dominant interest shall be analyzed separately.
- f. An alternative test procedure may be adopted, wherein the frequency range is swept incrementally, with a step size not exceeding 4% of the start ad thereafter 4% of the preceding frequency value. The test level should be at least twice the value of the specified test level.
- g. In cases of dispute, the test procedure using a step size not exceeding 1% of the start and thereafter 1% of preceding frequency value shall take precedence.
- h. Attempts should be made to fully exercise the EUT during testing, and to fully interrogate all exercise modes selected for susceptibility.
- i. The use of special exercising programs is recommended.
- j. Testing shall be performed according to a Test Plan, which shall be included in the test report.
- k. It may be necessary to carry out some investigatory testing in order to establish some aspects of the test plan.

### 12.2. Test Severity Levels

Level	Voltage Level ( e.m.f. )
1	1 V
2	3 V
3	10 V
x	Specified
NOTE - x is an open class. This level can be specified in the product specification.	

### 12.3. Measurement Equipment

Instrument	Manufacturer	Model No.	Serial No.	Calibration Date	Valid Date
CS GENERATOR	Schaffner	NSG 2070	1059	2013/09/11	2014/09/10
CDN (M2+M3)	Schaffner	M016	20056	2013/09/14	2014/09/13
CDN	Schaffner	T400	19818	2013/09/14	2014/09/13
EM-CLAMP	Schaffner	KEMZ 801	19793	2013/09/14	2014/09/13



### 12.4. Test Result and Data

Final Test Result : **PASS**  
 Basic Standard : IEC 61000-4-6  
 Product Standard : EN 50130-4  
 Coupling mode : CDN-(M3) for AC power ports  
                   : EM-CLAMP for Signal Ports  
 Temperature : 25°C  
 Relative Humidity : 56 %  
 Atmospheric Pressure : 1016 hPa  
 Test Date : Mar. 19, 2014

Frequency : 0.15~100MHz, Modulation : AM 80%, 1KHz sine wave, Dwell time: 3s Frequency Step Size : 1 % of preceding frequency value			
Frequency	Test Mode	Voltage(V)	Result
0.15 ~ 100MHz	Power(M3)	10	A
0.15 ~ 100MHz	Clamp(10M/100M/1Gbps)	10	A
0.15 ~ 100MHz	Clamp(BNC)	10	A

Note: " A " normal performance within limits specified by the manufacturer, requestor or purchaser.

Test engineer:       Dora





### 12.5. Test Photographs



### 13. Power Frequency Magnetic Field Immunity Test

#### 13.1. Test Setup

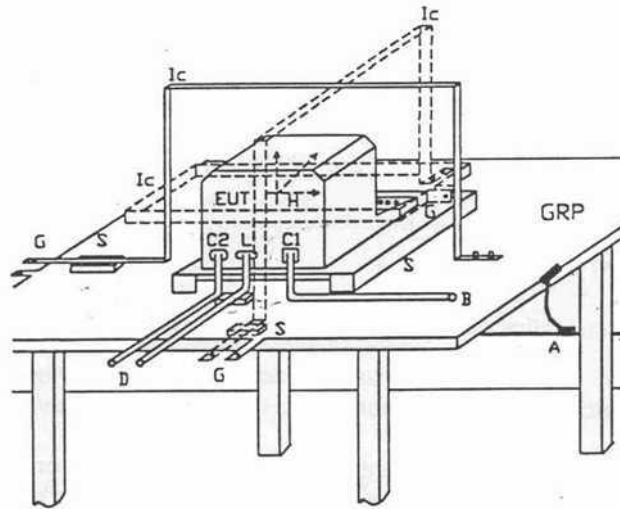

- GPR : Ground plane
- A : Safety earth
- S : Insulating support
- EUT : Equipment under test
- Lc : Induction coil
- E : Earth terminal
- C1 : Power supply circuit
- C2 : Signal circuit
- L : Communication line
- B : To power supply source
- D : To signal source, simulator
- G : To the test generator

#### 13.2. Test Severity Levels

Level	Magnetic field strength (A/m)
1	1
2	3
3	10
4	30
5	100
X <sup>1)</sup>	special

NOTE 1 "X" is an open level. This level can be given in the product specification.

#### 13.3. Measurement Equipment

Instrument	Manufacturer	Model No.	Serial No.	Calibration Date	Valid Date
MAGNETIC FIELD GENERATOR	KeyTek	F-1000-4-8-G-125A	N/A	2013/09/12	2014/09/11



13.4. Test Result and Data

Final Test Result : **PASS**  
 Basic Standard : IEC 61000-4-8  
 Product Standard : EN 50130-4  
 Temperature : 25 °C  
 Relative Humidity : 56 %  
 Atmospheric Pressure : 1016 hPa  
 Test Date : Mar. 19, 2014

Power Frequency Magnetic Field : <u>50</u> Hz, <u>1</u> A/m		
Coil Orientation	Testing duration	Results
X-axis	1.0 Min	A
Y-axis	1.0 Min	A
Z-axis	1.0 Min	A

Note: "A" normal performance within limits specified by the manufacturer, requestor or purchaser.

Test engineer: Dora



### 13.5. Test Photographs





## 14. Voltage Dips and Voltage Interruptions Immunity Test Setup

### 14.1. Test Conditions

1. Source voltage and frequency: AC 230V, Single phase.
2. Test of interval: 10 sec.
3. Level and duration: Sequence of 3 dips/interrupts.
4. Voltage rise (and fall) time: 1 ~ 5  $\mu$ s.
5. Test severity:

Test level Residual (%)	Test Durations (period)
>100%	250
20%	250
30%	25
60%	10

### 14.2. Measurement Equipment

Instrument	Manufacturer	Model No.	Serial No.	Calibration Date	Valid Date
TESQ NSG3060	TESQ	NSG3060	1385	2013/04/11	2014/04/10



14.3. Test Result and Data

Final Test Result : **PASS**  
 Basic Standard : IEC 61000-4-11  
 Product Standard : EN 50130-4  
 Temperature : 25 °C  
 Relative Humidity : 56 %  
 Atmospheric Pressure : 1016 hPa  
 Test Date : Mar. 19, 2014

Voltage(UT): AC <u>230</u> V <u>50</u> Hz Interval(s) : <u>10s</u> Times : <u>3</u>				
Test mode	Test level UT %	Durations (period)	Phase / Result	
			0°	180°
Voltage interruptions	>100%	250	A	A
Voltage dips	20%	250	A	A
	30%	25	A	A
	60%	10	A	A

Note: "A" normal performance within limits specified by the manufacturer, requestor or purchaser. It is permitted to use ancillary equipment (e.g. A UPS) to meet the requirements of this clause.

Test engineer: 



### 14.4. Test Photographs





### 15. Mains Supply Voltage Variations Test

#### 15.1. Test Conditions

- 1. Source voltage and frequency : 230V, 50Hz, Single phase.
- 2. Test severity :

Test level UT %	Durations
+10%	10min
-15%	10min

#### 15.2. Measurement Equipment

Instrument	Manufacturer	Model No.	Serial No.	Calibration Date	Valid Date
TESQ NSG3060	TESQ	NSG3060	1385	2013/04/11	2014/04/10

#### 15.3. Test Result and Data

Test Mode: Mode 1 & Mode 2

Voltage(UT): AC <u>230</u> V <u>50</u> Hz			
Test Mode	Test level UT %	Durations	Phase / Result
Voltage	+10%	10min	A
	-15%	10min	A

Test engineer: Yosa





### Appendix A. Photographs of EUT











