

SUPER ®

SUPER ® C7P67

## USER'S MANUAL

Revision 1.0c

---

The information in this User's Manual has been carefully reviewed and is believed to be accurate. The vendor assumes no responsibility for any inaccuracies that may be contained in this document, and makes no commitment to update or to keep current the information in this manual, or to notify any person or organization of the updates. **Please Note: For the most up-to-date version of this manual, please see our web site at [www.supermicro.com](http://www.supermicro.com).**

Super Micro Computer, Inc. ("Supermicro") reserves the right to make changes to the product described in this manual at any time and without notice. This product, including software, if any, and documentation may not, in whole or in part, be copied, photocopied, reproduced, translated or reduced to any medium or machine without prior written consent.

IN NO EVENT WILL SUPER MICRO COMPUTER, INC. BE LIABLE FOR DIRECT, INDIRECT, SPECIAL, INCIDENTAL, SPECULATIVE OR CONSEQUENTIAL DAMAGES ARISING FROM THE USE OR INABILITY TO USE THIS PRODUCT OR DOCUMENTATION, EVEN IF ADVISED OF THE POSSIBILITY OF SUCH DAMAGES. IN PARTICULAR, SUPER MICRO COMPUTER, INC. SHALL NOT HAVE LIABILITY FOR ANY HARDWARE, SOFTWARE, OR DATA STORED OR USED WITH THE PRODUCT, INCLUDING THE COSTS OF REPAIRING, REPLACING, INTEGRATING, INSTALLING OR RECOVERING SUCH HARDWARE, SOFTWARE, OR DATA.

---

Any disputes arising between manufacturer and customer shall be governed by the laws of Santa Clara County in the State of California, USA. The State of California, County of Santa Clara shall be the exclusive venue for the resolution of any such disputes. Supermicro's total liability for all claims will not exceed the price paid for the hardware product.

---

FCC Statement: This equipment has been tested and found to comply with the limits for a Class A digital device pursuant to Part 15 of the FCC Rules. These limits are designed to provide reasonable protection against harmful interference when the equipment is operated in a commercial environment. This equipment generates, uses, and can radiate radio frequency energy and, if not installed and used in accordance with the manufacturer's instruction manual, may cause harmful interference with radio communications. Operation of this equipment in a residential area is likely to cause harmful interference, in which case you will be required to correct the interference at your own expense.

---

California Best Management Practices Regulations for Perchlorate Materials: This Perchlorate warning applies only to products containing CR (Manganese Dioxide) Lithium coin cells. "Perchlorate Material-special handling may apply. See [www.dtsc.ca.gov/hazardouswaste/perchlorate](http://www.dtsc.ca.gov/hazardouswaste/perchlorate)".

**WARNING:** Handling of lead solder materials used in this product may expose you to lead, a chemical known to the State of California to cause birth defects and other reproductive harm.

---

Manual Revision 1.0c

Release Date: June 1, 2011

Unless you request and receive written permission from Super Micro Computer, Inc., you may not copy any part of this document.

Information in this document is subject to change without notice. Other products and companies referred to herein are trademarks or registered trademarks of their respective companies or mark holders.

Copyright © 2011 by Super Micro Computer, Inc.  
All rights reserved.

## Preface

This manual is written for system integrators, PC technicians and knowledgeable PC users. It provides information for the installation and use of the **SUPER**® C7P67 motherboard.

### About This Motherboard

The **SUPER**® C7P67 supports a single Intel® 2nd Generation Core i3/i5/i7 processor in an LGA 1155 socket. With the Intel® P67 Express chipset built in, the C7P67 motherboard offers substantial enhancement in system performance and storage capability for high performance system platforms in a sleek package. Please refer to our website (<http://www.supermicro.com/products/>) for processor and memory support updates. This product is intended to be installed and serviced by professional technicians.

### Manual Organization

**Chapter 1** describes the features, specifications and performance of the motherboard, and provides detailed information on the Intel P67 Express chipset.

**Chapter 2** provides hardware installation instructions. Read this chapter when installing the processor, memory modules and other hardware components into the system. If you encounter any problems, see **Chapter 3**, which describes troubleshooting procedures for video, memory and system setup stored in the CMOS.

**Chapter 4** includes an introduction to the BIOS, and provides detailed information on running the CMOS Setup utility.

**Appendix A** provides BIOS Error Beep Codes.

**Appendix B** lists software program installation instructions.

**Appendix C** provides BIOS Recovery instructions.

## Conventions Used in This Manual

Pay special attention to the following symbols for proper motherboard installation and to prevent damage to the system or injury to yourself:



**Danger/Caution:** Instructions to be strictly followed to prevent catastrophic system failure or to avoid bodily injury,



**Warning:** Important information given to ensure proper system installation or to prevent damage to the components,



**Note:** Additional information given to differentiate between various models or to provide information for correct system setup.

## Contacting Supermicro

### Headquarters

Address: Super Micro Computer, Inc.  
980 Rock Ave.  
San Jose, CA 95131 U.S.A.

Tel: +1 (408) 503-8000

Fax: +1 (408) 503-8008

Email: [marketing@supermicro.com](mailto:marketing@supermicro.com) (General Information)  
[support@supermicro.com](mailto:support@supermicro.com) (Technical Support)

Web Site: [www.supermicro.com](http://www.supermicro.com)

### Europe

Address: Super Micro Computer B.V.  
Het Sterrenbeeld 28, 5215 ML  
's-Hertogenbosch, The Netherlands

Tel: +31 (0) 73-6400390

Fax: +31 (0) 73-6416525

Email: [sales@supermicro.nl](mailto:sales@supermicro.nl) (General Information)  
[support@supermicro.nl](mailto:support@supermicro.nl) (Technical Support)  
[rma@supermicro.nl](mailto:rma@supermicro.nl) (Customer Support)

### Asia-Pacific

Address: Super Micro Computer, Inc.  
4F, No. 232-1, Liancheng Rd.  
Chung-Ho 235, Taipei County  
Taiwan, R.O.C.

Tel: +886-(2) 8226-3990

Fax: +886-(2) 8226-3991

Web Site: [www.supermicro.com.tw](http://www.supermicro.com.tw)

Technical Support:

Email: [support@supermicro.com.tw](mailto:support@supermicro.com.tw)

Tel: 886-2-8228-1366, ext.132 or 139

# Table of Contents

## **Preface**

### **Chapter 1 Introduction**

1-1	Overview .....	1-1
1-2	Chipset Overview .....	1-9
	Intel P67 Express Chipset Features .....	1-9
1-3	Special Features .....	1-10
	Recovery from AC Power Loss .....	1-10
1-4	PC Health Monitoring .....	1-10
	Fan Status Monitor with Firmware Control .....	1-10
	Environmental Temperature Control .....	1-10
	System Resource Alert .....	1-10
1-5	ACPI Features .....	1-11
1-6	Power Supply .....	1-11

### **Chapter 2 Installation**

2-1	Static-Sensitive Devices .....	2-1
	Precautions .....	2-1
	Unpacking .....	2-1
2-2	Processor and Heatsink Installation .....	2-2
	Installing the LGA1155 Processor .....	2-2
	Installing an Active Fan CPU Heatsink .....	2-5
	Removing the Heatsink .....	2-7
2-3	Installing DDR3 Memory .....	2-8
	DIMM Installation .....	2-8
	Removing Memory Modules .....	2-8
	Memory Support .....	2-9
	Memory Population Guidelines .....	2-9
2-4	Motherboard Installation .....	2-11
	Tools Needed .....	2-11
	Location of Mounting Holes .....	2-11
	Installing the Motherboard .....	2-12
2-5	Connectors/IO Ports .....	2-13
	Backplane I/O Panel .....	2-13
	ATX PS/2 Keyboard/Mouse Ports .....	2-14
	Universal Serial Bus (USB) .....	2-15
	Ethernet Ports .....	2-16
	(Back_Panel) High Definition Audio (HD Audio) .....	2-17

	Front Accessible Audio Header .....	2-17
	Front Control Panel .....	2-18
	Front Control Panel Pin Definitions .....	2-19
	Power LED .....	2-19
	HDD LED .....	2-19
	NIC1/NIC2 (LAN1/LAN2) .....	2-20
	Overheat (OH)/Fan Fail .....	2-20
	Reset Button .....	2-21
	Power Button .....	2-21
2-6	Connecting Cables .....	2-22
	ATX Main PWR & CPU PWR Connectors .....	2-22
	Fan Headers .....	2-23
	Chassis Intrusion .....	2-23
	Internal Buzzer .....	2-24
	Speaker .....	2-24
	Serial Ports .....	2-26
	TPM Header/Port 80 .....	2-26
	DOM PWR Connector .....	2-27
	Wake-On-LAN .....	2-27
	Wake-On-Ring .....	2-28
	SPDIF_In/SPDIF_Out Headers .....	2-28
2-7	Jumper Settings .....	2-29
	Explanation of Jumpers .....	2-29
	LAN Port Enable/Disable .....	2-29
	CMOS Clear .....	2-30
	PCI Slot SMB Enable .....	2-30
	Audio Enable .....	2-31
	IEEE 1394a Enable .....	2-31
	ME Recovery Enable .....	2-32
	HD FP Audio/AC' 97 FP Audio Select .....	2-32
2-8	Onboard Indicators .....	2-33
	LAN 1/LAN 2 LEDs .....	2-33
	Onboard Power LED .....	2-33
2-9	SATA Connections .....	2-34
	SATA Connections .....	2-34
<b>Chapter 3 Troubleshooting</b>		
3-1	Troubleshooting Procedures .....	3-1
	Before Power On .....	3-1

	No Power .....	3-1
	No Video .....	3-2
	Memory Errors .....	3-2
	Losing the System's Setup Configuration .....	3-2
3-2	Technical Support Procedures .....	3-2
3-3	Frequently Asked Questions .....	3-3
3-4	Battery Removal and Installation .....	3-5
	Battery Removal .....	3-5
	Proper Battery Disposal .....	3-5
3-5	Returning Merchandise for Service .....	3-6
	Battery Installation .....	3-6

**Chapter 4 BIOS**

4-1	Introduction .....	4-1
	Starting BIOS Setup Utility .....	4-1
	How To Change the Configuration Data .....	4-1
	How to Start the Setup Utility .....	4-2
4-2	Main Setup .....	4-2
4-3	Advanced Setup Configurations .....	4-4
4-4	Security .....	4-19
4-5	Boot Configuration .....	4-20
4-6	Exit Options .....	4-21

**Appendix A BIOS Error Beep Codes**

A-1	BIOS Error Beep Codes .....	A-1
-----	-----------------------------	-----

**Appendix B Software Installation Instructions**

B-1	Installing Drivers .....	B-1
B-2	Configuring Supero Doctor III .....	B-2

**Appendix C UEFI BIOS Recovery Instructions**

C-1	An Overview to the UEFI BIOS .....	C-1
C-2	How to Recover the UEFI BIOS Image (-the Main BIOS Block) .....	C-1
C-3	To Recover the Boot Sector Using a USB-Attached Device .....	C-1



# Chapter 1

## Introduction

### 1-1 Overview

#### Checklist

Congratulations on purchasing your computer motherboard from an acknowledged leader in the industry. Supermicro boards are designed with the utmost attention to detail to provide you with the highest standards in quality and performance.

Please check that the following items have all been included with your motherboard. If anything listed here is damaged or missing, contact your retailer.

The following items are included in the retail box.

- One (1) Supermicro Mainboard
- Six (6) SATA cables
- One (1) I/O shield
- One (1) 1394a bracket
- One (1) Supermicro CD containing drivers and utilities
- One (1) User's Manual
- One (1) Quick Installation Guide

## SUPER<sup>®</sup> Motherboard Image (C7P67 Shown)

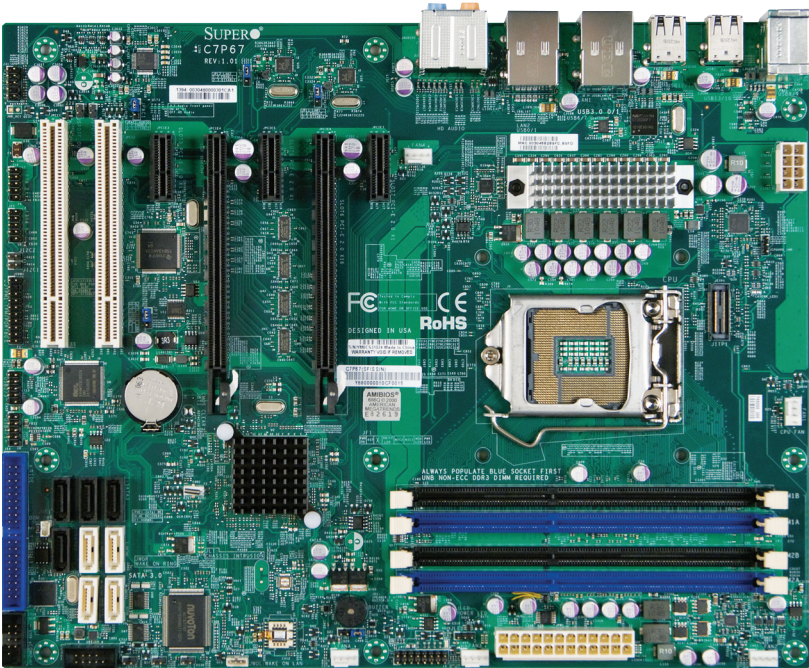

 **Note:** All graphics shown in this manual were based upon the latest PCB Revision available at the time of publishing of the manual. The motherboard you've received may or may not look exactly the same as the graphics shown in this manual.

## C7P67 Motherboard Layout

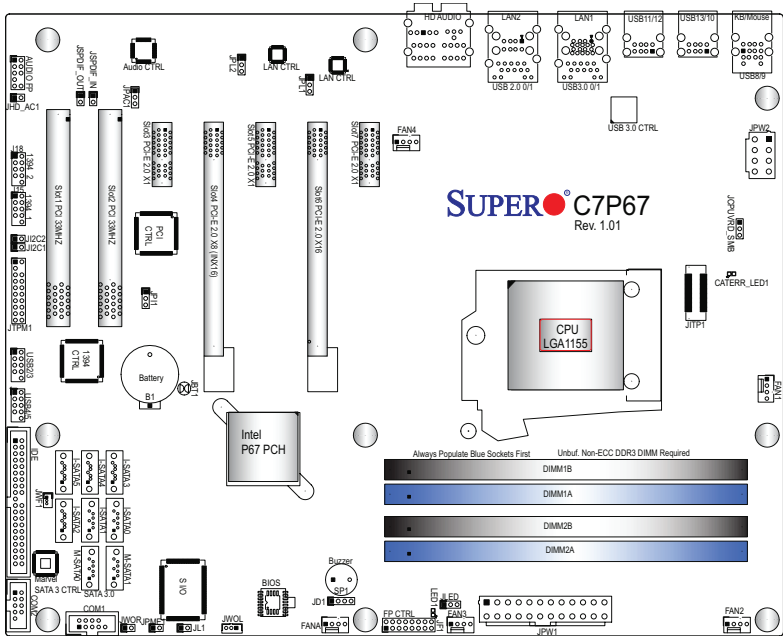

### Important Notes to the User

- See Chapter 2 for detailed information on jumpers, I/O ports and JF1 front panel connections.
- "■" indicates the location of "Pin 1".
- Jumpers not indicated are for testing only.
- When LED1 (Onboard Power LED Indicator) is on, system power is on. Unplug the power cable before installing or removing any components.
- CPU Overclocking is supported by this motherboard; however, SMCI does not recommend CPU Overclocking and cannot resume any responsibility or liability of out\_of\_spec. overclocking.
- CATERR\_LED is for internal testing only.

C7P67 Quick Reference

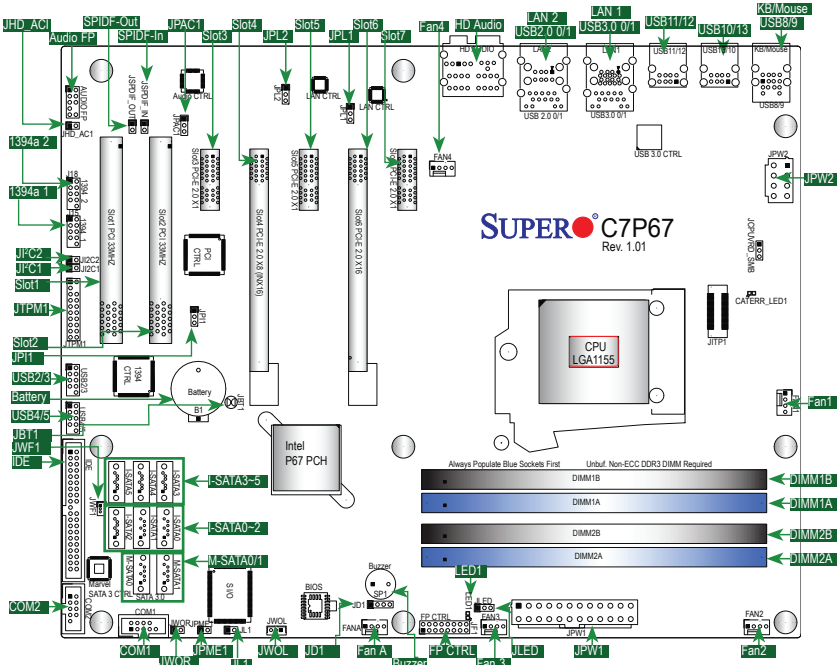

C7P67 Jumpers		
Jumper	Description	Default
JBT1	CMOS Clear	(See Chpt. 2)
JHD_AC1	High Definition Front Panel Audio/AC 97' FP Audio Select	(See Chpt. 2)
J <sup>2</sup> C1/J <sup>2</sup> C2	SMB to PCI Slots	Off (Enabled)
JPAC1	Audio Enable	Pins 1-2 (Enabled)
JPI1	IEEE 1394 Enable	Pins 1-2 (Enabled)
JPL1/JPL2	LAN1/LAN2 Enable	Pins 1-2 (Enabled)
JPME1	Intel ME Mode Select	Off (Normal)

<b>C7P67 Headers/Connectors</b>	
<b>Connector</b>	<b>Description</b>
Audio_FP	Front Panel Audio Header
HD Audio	High-Definition Audio Connector
B1	Onboard Battery
COM1/COM2	COM1/2 Serial Connection Headers
BIOS	AMI SPI BIOS
Fans 1~4, Fan A	System/CPU Fan Headers (Fan1: CPU Fan)
J15/J18	IEEE 1394_1 (J15)/1394_2 (J18) Headers
JCPUVRD SMB	PWM SMB programming header (for debugging only)
IDE	IDE Connector Header
JD1	Speaker/buzzer (Pins 1-2: Buzzer, Pins 1~4: External Speaker)
JF1	Front Panel Control Header
JL1	Chassis Intrusion Header
JLED	Power LED Indicator Header
JPW1	24-pin ATX Main Power Connector (Required)
JPW2	+12V 8-pin CPU power Connector (Required)
KB/Mouse	Keyboard/Mouse Connectors
LAN1/LAN2	Gigabit (RJ45) Ports (LAN1/2)
JSPDIF_In/JSPDIF_OUT	SPDIF_(Sony/Philips Digital Interface)_In/ SPDIF_Out Headers
JTPM1	Trusted Platform Module (TPM)/80 Port Header
JWF1	SATA DOM (Device_On_Module) Power Connector
JWOL	Wake_On_LAN Header
JWOR	Wake_On-Ring Header
Slot1/Slot2	PCI 33 MHz Slots
Slot3/Slot5/Slot7	PCI-Express 2.0 x1 Slots
Slot4	PCI-Express 2.0 x8 in x16 Slot
Slot6	PCI-Express 2.0 x16 Slot
(I-)SATA (3.0) 0/1, (2.0) 2~5	(Intel) Serial ATA 3.0 Ports 0/1. Serial ATA 2.0 2~5
(M-)SATA (3.0) 0/1	(Marvel) Serial ATA 3.0 Ports 0/1
SP1	Internal Buzzer
USB (2.0) 0/1, 8/9, 11/12, 13/10	Backpanel USB 2.0 Ports 0/1, 8/9, 11/12, 13/10
USB (3.0) 0/1	Backpanel USB 3.0 Ports 0/1
USB2/3, USB4/5	Front Accessible USB Connections 2/3, 4/5

<b>C7P67 LED Indicators</b>			
<b>LED</b>	<b>Description</b>	<b>Color/State</b>	<b>Status</b>
LED1	Onboard Standby PWR LED	Green: Solid on	Power On

## Motherboard Features

<b>CPU</b>	Intel® 2nd Generation Core i3/i5/i7 processor in an LGA1155 socket.		
<b>Memory</b>	Four (4) SDRAM slots support up to 32 GB of DDR3 Unbuffered, Non-ECC 1333/1066 memory		
	Supports dual-channel memory bus		
	<b>DIMM sizes</b>		
	UDIMM	1 GB, 2 GB, 4GB, and 8GB	
<b>Chipset</b>	Intel® P67 Express		
<b>Expansion Slots</b>	Three (3) PCI Express 2.0 x1 slots (Slot3, Slot5, Slot7)		
	One (1) PCI Express x8 in x16 slot (Slot4)		
	One (1) PCI Express x16 slot (Slot6), or One (1) PCI Express x8 slot when Slot4 in use.		
	Two (2) PCI 33 MHz slots (Slot1/Slot2)		
<b>Network Connections</b>	Two (2) Realtek RTL8111E Gigabit Ethernet Controllers		
	Two (2) RJ-45 Rear IO Panel Connectors with Link and Activity LEDs		
<b>I/O Devices</b>	<b>SATA Connections</b>		
	<ul style="list-style-type: none"> <li>SATA 3.0</li> </ul>	<ul style="list-style-type: none"> <li>Four (4) M-SATA 0/1 and I-SATA 0/1</li> </ul>	
	<ul style="list-style-type: none"> <li>SATA2.0</li> </ul>	<ul style="list-style-type: none"> <li>Four (4) (I-SATA 2~5)</li> </ul>	
	RAID (Windows)	RAID 0, 1, 5, 10	
	RAID (Linux)	RAID 0, 1, 10	
	<b>USB Devices</b>		
	Two (2) USB 3.0 ports on the rear IO panel (USB 3.0 0/1)		
	Eight (8) USB 2.0 ports on the rear IO panel (USB 0/1, USB 8/9, USB 11/12, USB 10/13)		
	Four (4) Front Accessible USB 2.0 ports (USB 2/3, USB 4/5)		
	<b>Keyboard/Mouse</b>		
	PS/2 Keyboard/Mouse ports on the I/O backpanel		
	<b>Serial (COM) Ports</b>		
	Two (2) Fast UART 16550 front accessible headers		
<b>Audio</b>			
High_Definition Backpanel Audio Connector			
Front Panel Audio Connector			

	SPDIF_In and SPDIF_Out Headers
	<b>DOM Power Connector</b>
	DOM (Disk_on_Module) Power Connector
	<b>Super I/O</b>
	Nuvoton NCT6776F
<b>BIOS</b>	32 Mb AMI BIOS® SPI Flash BIOS
	Play and Plug (PnP0, DMI 2.3, PCI 2.3, ACPI 1.0/2.0/3.0, USB Keyboard and SMBIOS 2.5)
<b>Power Configuration</b>	ACPI/ACPM Power Management
	Main Switch Override Mechanism
	Keyboard Wake-up from Soft-Off
	Internal/External Modem Ring-On
	Power-on mode for AC power recovery
<b>PC Health Monitoring</b>	<b>CPU Monitoring</b>
	Onboard voltage monitors for CPU core, +3.3V, +5V, +12V, +3.3V Stdbv, VBAT, Memory, VCORE for CPU
	CPU 4-phase switching voltage regulator
	CPU/System overheat LED and control
	CPU Thermal Trip support
	Thermal Monitor 2 (TM2) support
	<b>Fan Control</b>
	Fan status monitoring with firmware 4-pin (Pulse Width Modulation) fan speed control
	Low noise fan speed control
<b>System Management</b>	PECI (Platform Environment Configuration Interface) 2.0 support
	System resource alert via Supero Doctor III
	SuperoDoctor III, Watch Dog, NMI
	Chassis Intrusion header and detection
<b>CD Utilities</b>	BIOS flash upgrade utility
	Drivers and software for Intel® P67 Express chipset utilities
<b>Other</b>	ROHS 6/6 (Full Compliance, Lead Free)
<b>Dimensions</b>	ATX form factor (9.6" x 12.0") (243.84mm x 304.80mm)

### C7P67 Block Diagram

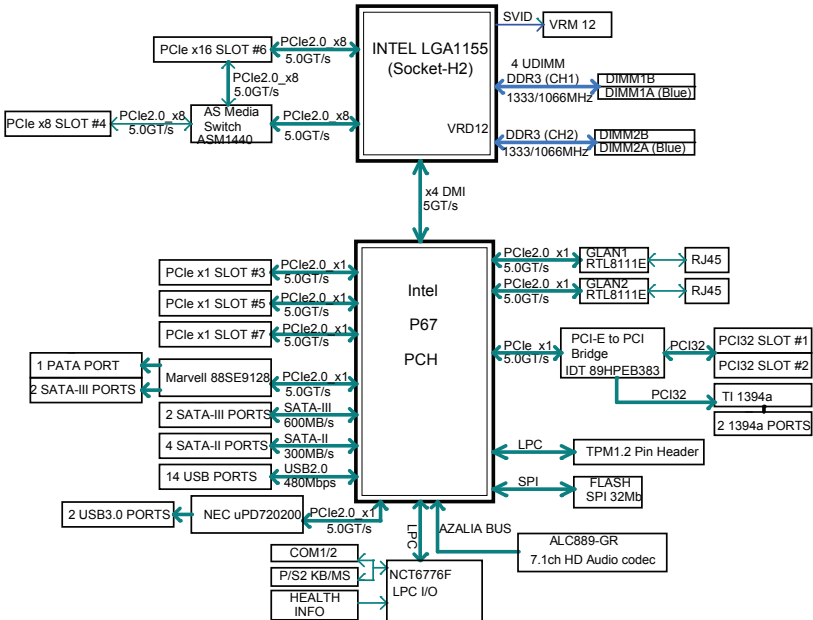

### System Block Diagram



**Note:** This is a general block diagram and may not exactly represent the features on your motherboard. See the Motherboard Features pages for the actual specifications of each motherboard.



## 1-2 Chipset Overview

The C7P67 supports a single Intel® 2nd Generation Core i3/i5/i7 processor in the LGA 1155 Socket. Built upon the functionality and the capability of the P67 Express chipset, the motherboard provides substantial enhancement to system performance and storage capability for high performance platforms in a sleek package.

### **Intel P67 Express Chipset Features**

- Supports Intel 2nd Generation Core i3/i5/i7 CPU
- Direct Media Interface (up to 10 Gb/s transfer, Full Duplex)
- Intel® Matrix Storage Technology
- PCI Express 2.0 Interface (up to 5.0 GT/s)
- SATA Controller (up to 6G/s)
- Advanced Host Controller Interface (AHCI)

## 1-3 Special Features

### Recovery from AC Power Loss

Basic I/O System (BIOS) provides a setting for you to determine how the system will respond when AC power is lost and then restored to the system. You can choose for the system to remain powered off, (in which case you must press the power switch to turn it back on), or for it to automatically return to a power-on state. See the Advanced BIOS Setup section to change this setting. The default setting is **Last State**.

## 1-4 PC Health Monitoring

This section describes the PC health monitoring features of the board. All have an onboard System Hardware Monitoring chip that supports PC health monitoring. An onboard voltage monitor will scan these onboard voltages continuously: CPU Vcore, NIC Vcore, 12V, 1.5V, 3.3V, 3.3VSB, and Battery Voltage. Once a voltage becomes unstable, a warning is given, or an error message is sent to the screen. The user can adjust the voltage thresholds to define the sensitivity of the voltage monitor.

### Fan Status Monitor with Firmware Control

PC health monitoring in the BIOS can check the RPM status of the cooling fans. The onboard CPU and chassis fans are controlled by Thermal Management via BIOS (under the Hardware Monitoring section in the Advanced Setting).

### Environmental Temperature Control

The thermal control sensor monitors the CPU temperature in real time and will turn on the thermal control fan whenever the CPU temperature exceeds a user-defined threshold. The overheat circuitry runs independently from the CPU. Once the thermal sensor detects that the CPU temperature is too high, it will automatically turn on the thermal fans to prevent the CPU from overheating. The onboard chassis thermal circuitry can monitor the overall system temperature and alert the user when the chassis temperature is too high.

 **Note:** To avoid possible system overheating, please be sure to provide adequate airflow to your system.

### System Resource Alert

This feature is available when the system is used with Supero Doctor III in the Windows OS environment or used with Supero Doctor II in Linux. Supero Doctor is used to notify the user of certain system events. For example, you can

---

also configure Supero Doctor to provide you with warnings when the system temperature, CPU temperatures, voltages and fan speeds go beyond predefined thresholds.

## 1-5 ACPI Features

ACPI stands for Advanced Configuration and Power Interface. The ACPI specification defines a flexible and abstract hardware interface that provides a standard way to integrate power management features throughout a PC system, including its hardware, operating system and application software. This enables the system to automatically turn on and off peripherals such as CD-ROMs, network cards, hard disk drives and printers.

In addition to enabling operating system-directed power management, ACPI also provides a generic system event mechanism for Plug and Play, and an operating system-independent interface for configuration control. ACPI leverages the Plug and Play BIOS data structures, while providing a processor architecture-independent implementation that is compatible with Windows Vista, and Windows 7 Operating Systems.

## 1-6 Power Supply

As with all computer products, a stable power source is necessary for proper and reliable operation. It is even more important for processors that have high CPU clock rates.

This motherboard accommodates 24-pin ATX power supplies. Although most power supplies generally meet the specifications required by the CPU, some are inadequate. In addition, the 12V 8-pin power connector located at JPW2 is also required to ensure adequate power supply to the system. Also your power supply must supply 1.5A for the Ethernet ports.



**Warning!** 1. To prevent damage to the power supply or motherboard, please use a power supply that contains a 24-pin and a 8-pin power connectors. Be sure to connect these connectors to the 24-pin (JPW1) and the 8-pin (JPW2) power connectors on the motherboard. Failure in doing so will void the manufacturer warranty on your power supply and motherboard.

2. To provide adequate power to SATA devices, please connect the SATA DOM PWR connector (JWF1) to the power supply.

It is strongly recommended that you use a high quality power supply that meets ATX power supply Specification 2.02 or above. It must also be SSI compliant. (For more information, please refer to the web site at <http://www.ssiforum.org/>). Additionally, in areas where noisy power transmission is present, you may choose to install a line

filter to shield the computer from noise. It is recommended that you also install a power surge protector to help avoid problems caused by power surges.

## Chapter 2

### Installation

#### 2-1 Static-Sensitive Devices

Electrostatic-Discharge (ESD) can damage electronic components. To avoid damaging your system board, it is important to handle it very carefully. The following measures are generally sufficient to protect your equipment from ESD.

##### Precautions

- Use a grounded wrist strap designed to prevent static discharge.
- Touch a grounded metal object before removing the board from the antistatic bag.
- Handle the board by its edges only; do not touch its components, peripheral chips, memory modules or gold contacts.
- When handling chips or modules, avoid touching their pins.
- Put the motherboard and peripherals back into their antistatic bags when not in use.
- For grounding purposes, make sure your computer chassis provides excellent conductivity between the power supply, the case, the mounting fasteners and the motherboard.
- Use only the correct type of onboard CMOS battery. Do not install the onboard battery upside down to avoid possible explosion.

##### Unpacking

The motherboard is shipped in antistatic packaging to avoid static damage. When unpacking the board, make sure that the person handling it is static protected.

## 2-2 Processor and Heatsink Installation

 **Warning:** When handling the processor package, avoid placing direct pressure on the label area of the fan.

 **Notes:**

Always connect the power cord last, and always remove it before adding, removing or changing any hardware components. Make sure that you install the processor into the CPU socket before you install the CPU heatsink.

If you buy a CPU separately, make sure that you use an Intel-certified multi-directional heatsink only.

Make sure to install the system board into the chassis before you install the CPU heatsink.

When receiving a server board without a processor pre-installed, make sure that the plastic CPU socket cap is in place and none of the socket pins are bent; otherwise, contact your retailer immediately.

Refer to the Supermicro website for updates on CPU support.

### Installing the LGA1155 Processor

1. Press the load lever to release the load plate, which covers the CPU socket, from its locking position.

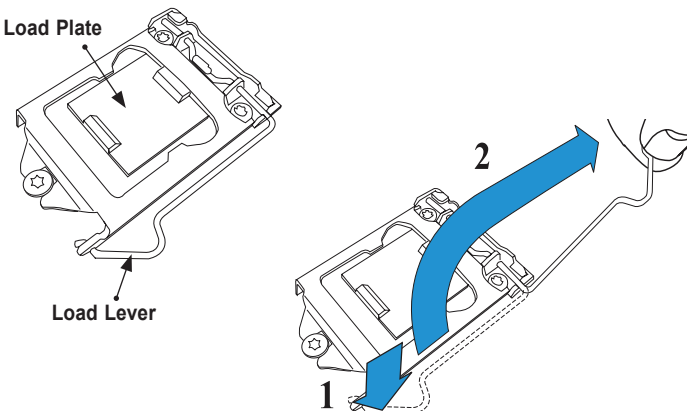

2. Gently lift the load lever to open the load plate. Remove the plastic cap.

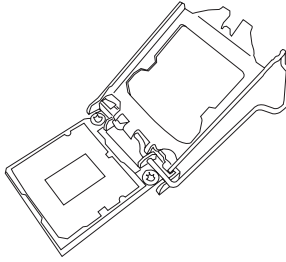

3. Use your thumb and your index finger to hold the CPU at the North center edge and the South center edge of the CPU.

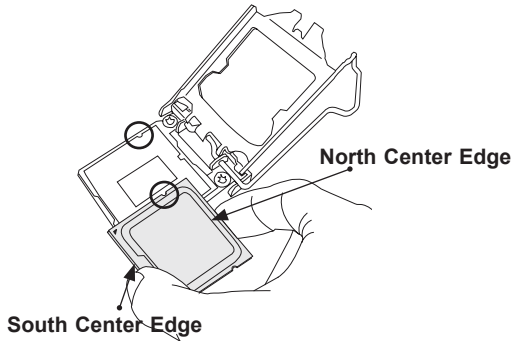

4. Align the CPU key that is the semi-circle cutouts against the socket keys. Once it is aligned, carefully lower the CPU straight down into the socket. (Do not drop the CPU on the socket. Do not move the CPU horizontally or vertically.)

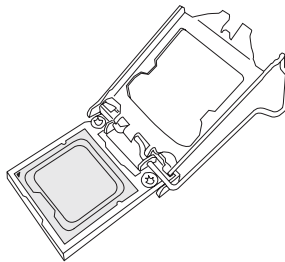

5. Do not rub the CPU against the surface or against any pins of the socket to avoid damaging the CPU or the socket.)

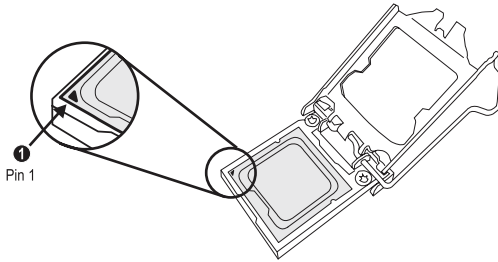

6. With the CPU inside the socket, inspect the four corners of the CPU to make sure that the CPU is properly installed.
7. Use your thumb to gently push the load lever down to the lever lock.

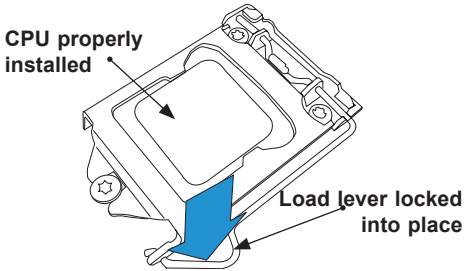

**Warning:** You can only install the CPU inside the socket only in one direction. Make sure that it is properly inserted into the CPU socket before closing the load plate. If it doesn't close properly, do not force it as it may damage your CPU. Instead, open the load plate again and double-check that the CPU is aligned properly.



## Installing an Active Fan CPU Heatsink

1. Locate the CPU Fan power connector on the motherboard. (Refer to the layout on the right for the CPU Fan location.)
2. Position the heatsink so that the heatsink fan wires are closest to the CPU fan power connector and are not interfered with other components.
3. Inspect the CPU Fan wires to make sure that the wires are routed through the bottom of the heatsink.
4. Remove the thin layer of the protective film from the heatsink.

 **Warning:** CPU overheat may occur if the protective film is not removed from the heatsink.

5. Apply the proper amount of thermal grease on the CPU.

 **Note:** if your heatsink came with a thermal pad, please ignore this step.

6. If necessary, rearrange the wires to make sure that the wires are not pinched between the heatsink and the CPU. Also make sure to keep clearance between the fan wires and the fins of the heatsink.

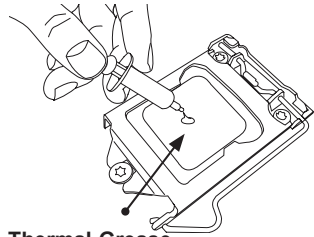

**Thermal Grease**

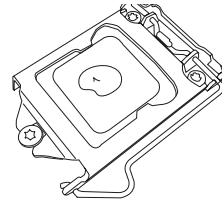

**Heatsink Fins**

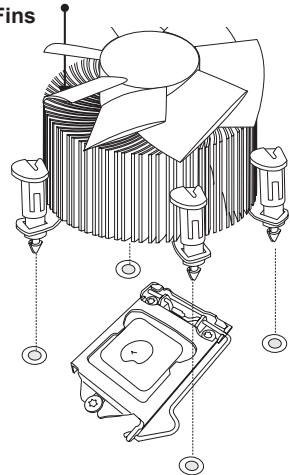

**Recommended Supermicro heatsink:  
SNK-P0046A4 active heatsink**

7. Align the four heatsink fasteners with the mounting holes on the motherboard. Gently push the pairs of diagonal fasteners (#1 & #2, and #3 & #4) into the mounting holes until you hear a click. Also, make sure to orient each fastener so that the narrow end of the groove is pointing outward.
8. Repeat Step 7 to insert all four heatsink fasteners into the mounting holes.
9. Once all four fasteners are securely inserted into the mounting holes, and the heatsink is properly installed on the motherboard, connect the heatsink fan wires to the CPU Fan connector.

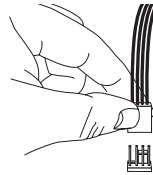
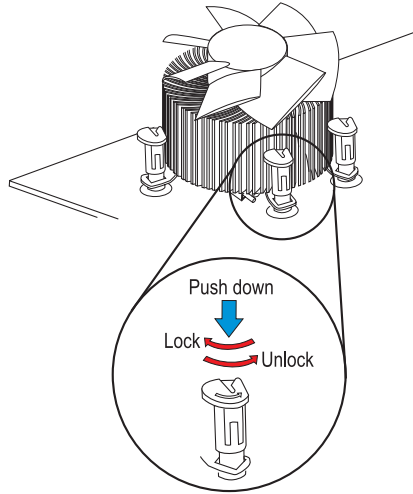

## Removing the Heatsink



**Warning:** We do not recommend that the CPU or the heatsink be removed. However, if you do need to remove the heatsink, please follow the instructions below to remove the heatsink and to prevent damage done to the CPU or other components.

### Active Heatsink Removal

1. Unplug the power cord from the power supply.
2. Disconnect the heatsink fan wires from the CPU fan header.
3. Use your finger tips to gently press on the fastener cap and turn it counterclockwise to make a 1/4 (90°) turn, and pull the fastener upward to loosen it.
4. Repeat Step 3 to loosen all fasteners from the mounting holes.
5. With all fasteners loosened, remove the heatsink from the CPU.

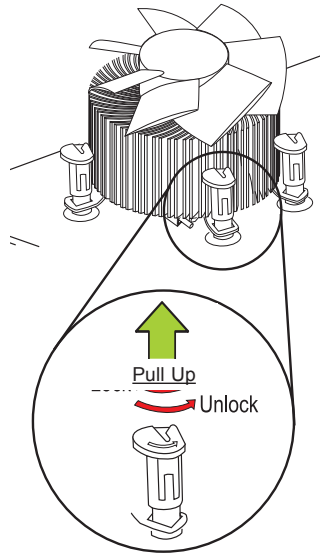
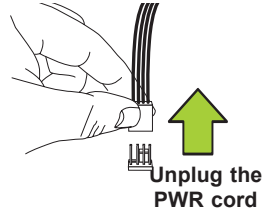

## 2-3 Installing DDR3 Memory

 **Note:** Check the Supermicro website for recommended memory modules.

### CAUTION

 Exercise extreme care when installing or removing DIMM modules to prevent any possible damage.

### DIMM Installation

1. Insert the desired number of DIMMs into the memory slots, starting with DIMM1A (Channel 1, Slot A). (For best performance, please use the memory modules of the same type and speed in the same bank.)
2. Push the release tabs outwards on both ends of the DIMM slot to unlock it.
3. Align the key of the DIMM module with the receptive point on the memory slot.
4. Align the notches on both ends of the module against the receptive points on the ends of the slot.

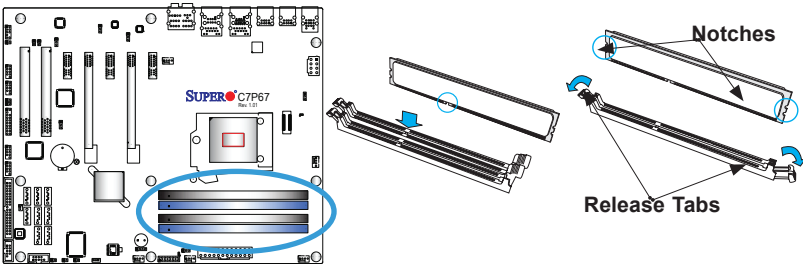

5. Use two thumbs together to press the notches on both ends of the module straight down into the slot until the module snaps into place.



6. Press the release tabs to the lock positions to secure the DIMM module into the slot.

### Removing Memory Modules

Reverse the steps above to remove the DIMM modules from the motherboard.

## Memory Support

The C7P67 supports up to 32GB of Unbuffered (UDIMM) DDR3 Non-ECC 1333/1066 MHz in 4 memory slots. Populating these DIMM modules with a pair of memory modules of the same type and same size will result in interleaved memory, which will improve memory performance. Please refer to the table below:

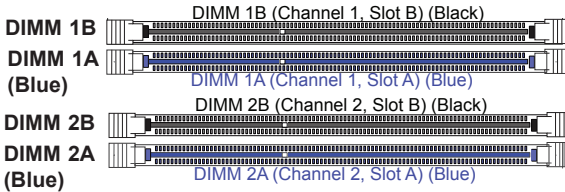

## Memory Population Guidelines

Please follow the table below when populating the C7P67.

DDR3 Unbuffered Non-ECC (UDIMM) Memory				
DIMM Slots per Channel	DIMMs Populated per Channel	DIMM Type	POR Speeds	Ranks per DIMM (any combination)
2	1	Unbuffered DDR3	1066, 1333	Single Rank, Dual Rank
2	2	Unbuffered DDR3	1066, 1333	Single Rank, Dual Rank

### Notes

- Due to memory allocation to system devices, the amount of memory that remains available for operational use will be reduced when 4 GB of RAM is used. The reduction in memory availability is disproportional. See the following table for details.
- For Microsoft Windows users: Microsoft implemented a design change in the Windows XP with Service Pack 2 (SP2) and Windows Vista. This change is specific to the behavior of Physical Address Extension (PAE) mode which improves driver compatibility. For more information, please read the following article at Microsoft's Knowledge Base website at: <http://support.microsoft.com/kb/888137>.

<b>Possible System Memory Allocation &amp; Availability</b>		
<b>System Device</b>	<b>Size</b>	<b>Physical Memory Remaining (-Available) (4 GB Total System Memory)</b>
Firmware Hub flash memory (System BIOS)	1 MB	3.99
Local APIC	4 KB	3.99
Area Reserved for the chipset	2 MB	3.99
I/O APIC (4 Kbytes)	4 KB	3.99
PCI Enumeration Area 1	256 MB	3.76
PCI Express (256 MB)	256 MB	3.51
PCI Enumeration Area 2 (if needed) -Aligned on 256-MB boundary-	512 MB	3.01
TSEG	1 MB	2.84
Memory available to OS and other applications		2.84

## 2-4 Motherboard Installation

All motherboards have standard mounting holes to fit different types of chassis. Make sure that the locations of all the mounting holes for both motherboard and chassis match. Although a chassis may have both plastic and metal mounting fasteners, metal ones are highly recommended because they ground the motherboard to the chassis. Make sure that the metal standoffs click in or are screwed in tightly. Then use a screwdriver to secure the motherboard onto the motherboard tray.

### Tools Needed



Philips Screwdriver



Philips Screws  
(9 Pieces)



Standoffs  
(9 Pieces)

### Location of Mounting Holes

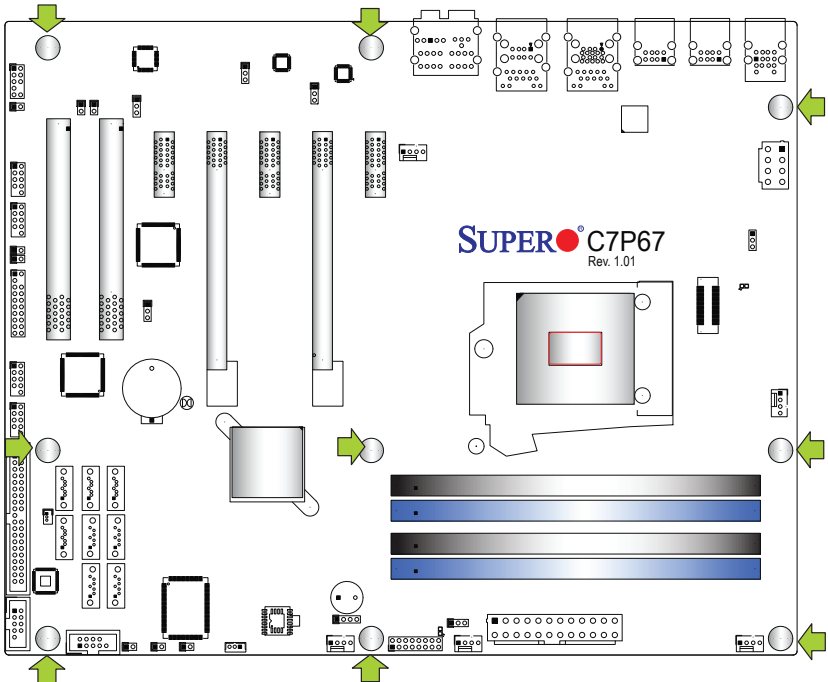

**Caution:** 1) To avoid damaging the motherboard and its components, please do not use a force greater than 8 lb/inch on each mounting screw during motherboard installation. 2) Some components are very close to the mounting holes. Please take precautionary measures to avoid damaging these components when installing the motherboard to the chassis.

## Installing the Motherboard

1. Install the I/O shield into the chassis.

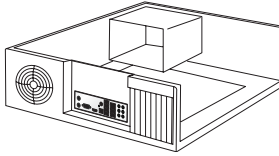

2. Locate the mounting holes on the motherboard. (See the previous page.)
3. Locate the matching mounting holes on the chassis. Align the mounting holes on the motherboard against the mounting holes on the chassis.
4. Install standoffs in the chassis as needed.

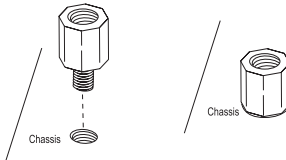

5. Install the motherboard into the chassis carefully to avoid damaging motherboard components.
6. Using the Philips screwdriver, insert a Pan head #6 screw into a mounting hole on the motherboard and its matching mounting hole on the chassis.

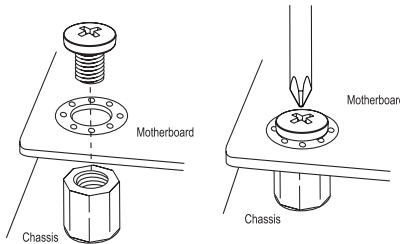

7. Repeat Step 5 to insert #6 screws into all mounting holes.
8. Make sure that the motherboard is securely placed in the chassis.

 **Note:** Images displayed are for illustration only. Your chassis or components might look different from those shown in this manual.



## 2-5 Connectors/I/O Ports

The I/O ports are color coded in conformance with the PC 99 specification. See the figure below for the colors and locations of the various I/O ports.

### Backplane I/O Panel

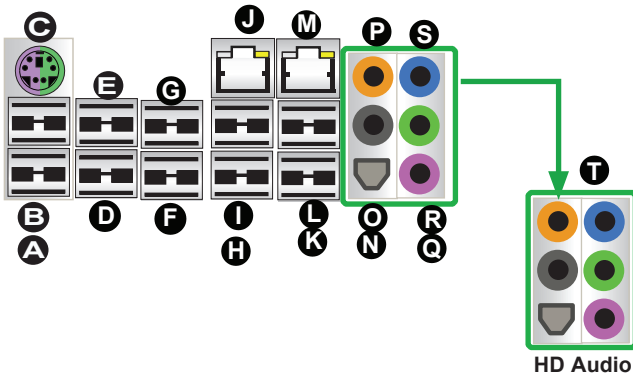
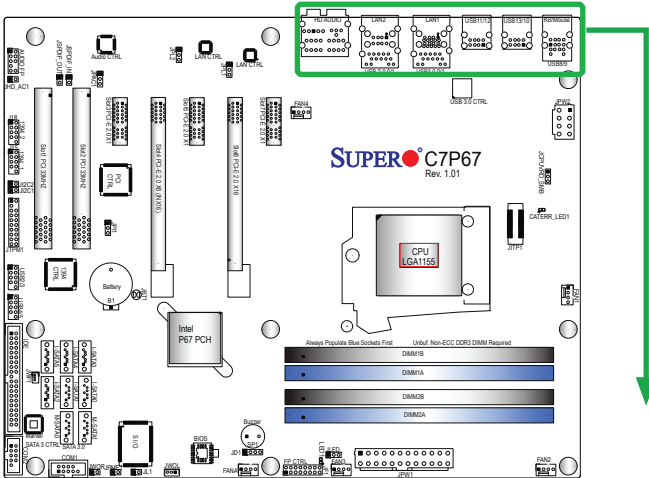

HD Audio

Backplane I/O Panel		
A. USB 2.0 Port 8	H. USB 3.0 Port 0	T. Backplane HD Audio
B. USB 2.0 Port 9	I. USB 3.0 Port 1	N. SPDIF_Out
C. Keyboard/Mouse	J. GLAN 1	O Surround_Out
D. USB 2.0 Port 13	K. USB 2.0 Port 0	P. CEN/LFE_Out
E. USB 2.0 Port 10	L. USB 2.0 Port 1	Q. Mic_In
F. USB 2.0 Port 11	M. GLAN 2	R. Line_Out
G. USB 2.0 Port 12		S. Line_In

**ATX PS/2 Keyboard/Mouse Ports**

The ATX PS/2 keyboard and PS/2 mouse are located next to the Back Panel USB Ports 13/10 on the motherboard. See the table at right for pin definitions.

PS/2 Keyboard/Mouse Pin Definitions			
PS2 Keyboard		PS2 Mouse	
Pin#	Definition	Pin#	Definition
1	KB Data	1	Mouse Data
2	No Connection	2	No Connection
3	Ground	3	Ground
4	Mouse/KB VCC (+5V)	4	Mouse/KB VCC (+5V)
5	KB Clock	5	Mouse Clock
6	No Connection	6	No Connection

VCC: with 1.5A PTC (current limit)

 **Note:**

This motherboard offers three Keyboard/Mouse connection options as shown in the graphic below.

- **A.** Connect a keyboard cable or a mouse cable to the PS2 KB/Mouse port.
- **B.** Connect an Y cable that includes a KB cable and a mouse cable to the PS2 KB/Mouse port.
- **C.** Connect a KB cable and a mouse cable to any USB ports.

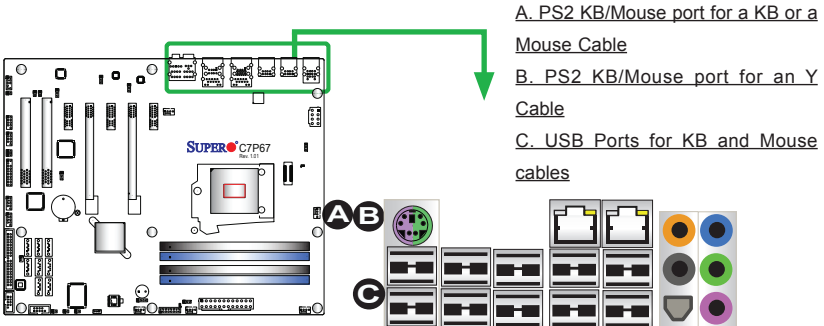
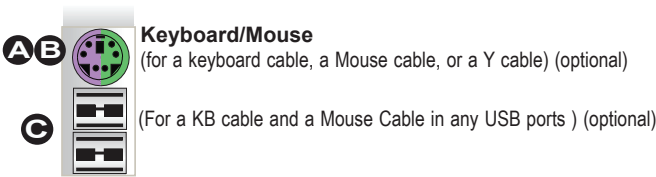

## Universal Serial Bus (USB)

Eight Universal Serial Bus 2.0 ports (USB 8/9, 13/10, 11/12, and 0/1) are located on the I/O back panel. In addition, two USB 3.0 Ports (USB 3.0 Ports 0/1) are also located above GLAN Port 1 on the backplane. Additionally, USB 2/3, 4/5 are used to provide front chassis access. USB Cables are not included. See the tables on the right for pin definitions.

Back Panel USB (2.0) #0/1, 8/9, 11/12, 13/10 Pin Definitions			
Pin#	Definition	Pin#	Definition
1	+5V	5	+5V
2	USB_PN1	6	USB_PN0
3	USB_PP1	7	USB_PP0
4	Ground	8	Ground

Back Panel USB (3.0) #0/1 Pin Definitions			
Pin#	Pin#	Signal Name	Description
1	10	VBUS	Power
2	11	D-	USB 2.0 Differential Pair
3	12	D+	
4	13	Ground	Ground of PWR Return
5	14	StdA_SSRX-	SuperSpeed Receiver
6	15	StdA_SSRX+	Differential Pair
7	16	GND_DRAIN	Ground for Signal Return
8	17	StdA_SSTX-	SuperSpeed Transmitter
9	18	StdA_SSTX+	Differential Pair

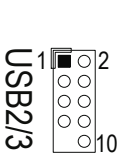

Front Panel USB (2.0) #2/3, 4/5 Pin Definitions			
USB 2/4		USB 3/5	
Pin #	Definition	Pin #	Definition
1	+5V	2	+5V
3	USB_PN2	4	USB_PN3
5	USB_PP2	6	USB_PP3
7	Ground	8	Ground
9	Key	10	Ground

- A. Backpanel USB 2.0 #8
- B. Backpanel USB 2.0 #9
- C. Backpanel USB 2.0 #13
- D. Backpanel USB 2.0 #10
- E. Backpanel USB 2.0 #11
- F. Backpanel USB 2.0 #12
- G. Backpanel USB 3.0 #0
- H. Backpanel USB 3.0 #1
- I. Backpanel USB 2.0 #0
- J. Backpanel USB 2.0 #1
- K. Front Panel USB 2.0 #2/3
- L. Front Panel USB 2.0 #4/5

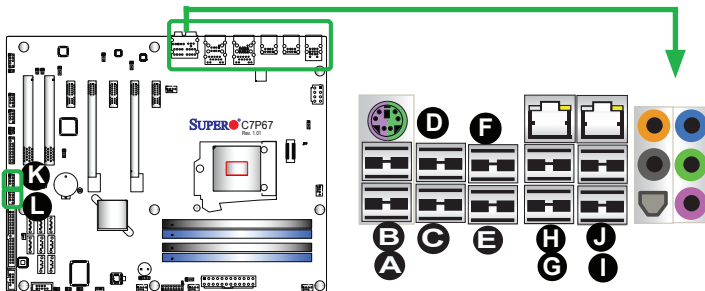

**Ethernet Ports**

Two Gigabit Ethernet ports (LAN1/ LAN2) are located next to the HD Audio Connector on the I/O Backpanel to provide network connections. These ports accept RJ45 type cables.

 **Note**

Please refer to the LED Indicator Section for LAN LED information.

LAN Ports Pin Definition			
Pin#	Definition		
1	P2V5SB	10	SGND
2	TD0+	11	Act LED
3	TD0-	12	P3V3SB
4	TD1+	13	Link 100 LED (Yellow, +3V3SB)
5	TD1-	14	Link 1000 LED (Yellow, +3V3SB)
6	TD2+	15	Ground
7	TD2-	16	Ground
8	TD3+	17	Ground
9	TD3-	88	Ground

(NC: No Connection)

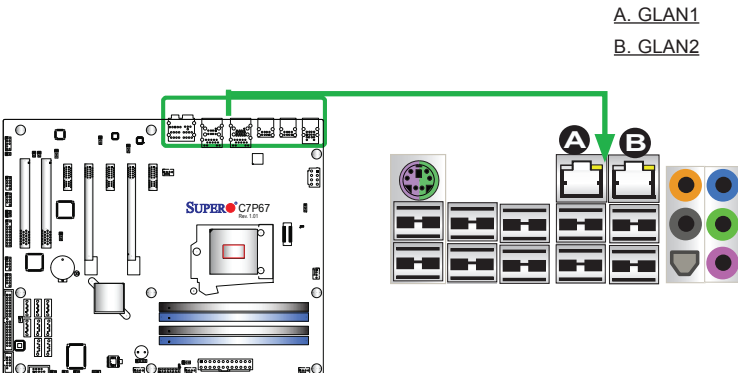

## (Back\_Panel) High Definition Audio (HD Audio)

This motherboard features a 7.1+2 Channel High Definition Audio (HDA) codec that provides 10 DAC channels. The HD Audio connections simultaneously supports multiple-streaming 7.1 sound playback with 2 channels of independent stereo output through the front panel stereo out for front, rear, center and subwoofer speakers. Use the Advanced software included in the CD-ROM with your motherboard to enable this function.

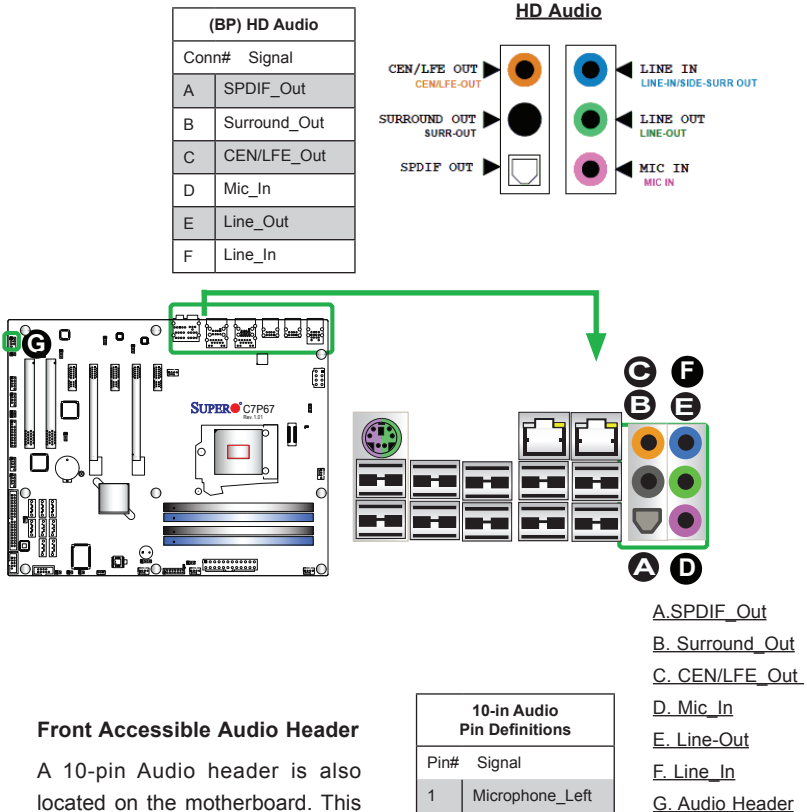

## Front Control Panel

JF1 contains header pins for various buttons and indicators that are normally located on a control panel at the front of the chassis. These connectors are designed specifically for use with Supermicro chassis. See the figure below for the descriptions of the front control panel buttons and LED indicators. Refer to the following section for descriptions and pin definitions.

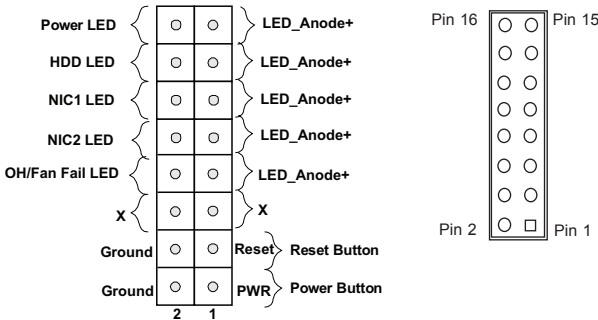
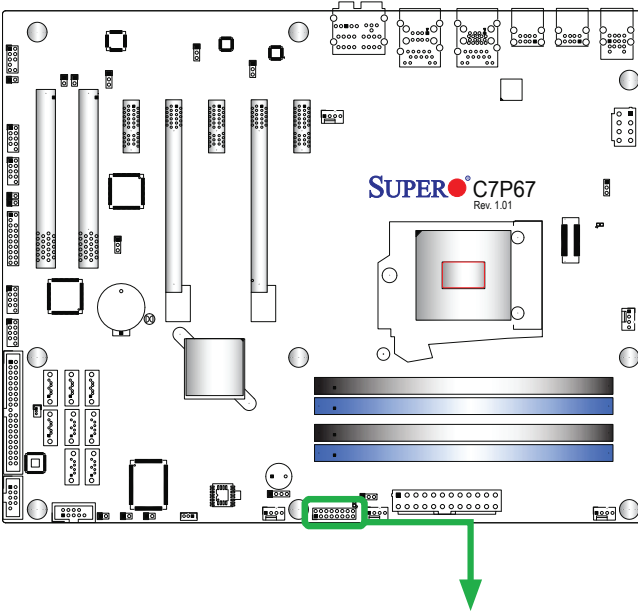

JF1 Header Pins

## Front Control Panel Pin Definitions

### Power LED

The Power LED connection is located on pins 15 and 16 of JF1. Refer to the table on the right for pin definitions.

Power LED Pin Definitions (JF1)	
Pin#	Definition
15	+5V
16	Ground

### HDD LED

The HDD LED connection is located on pins 13 and 14 of JF1. Attach a cable here to indicate the status of HDD-related activities, including IDE, SATA activities. See the table on the right for pin definitions.

HDD LED Pin Definitions (JF1)	
Pin#	Definition
13	+5V
14	HD Active

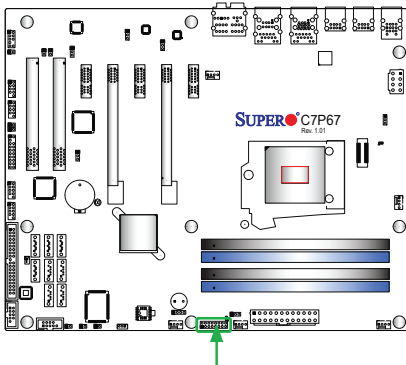

A. PWR LED

B. HDD LED

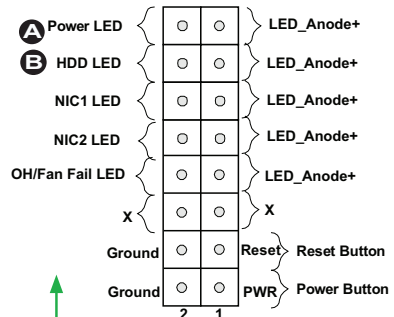

**NIC1/NIC2 (LAN1/LAN2)**

The NIC (Network Interface Controller) LED connection for LAN port 1 is located on pins 11 and 12 of JF1, and the LED connection for LAN Port 2 is on Pins 9 and 10. NIC1 LED and NIC2 LED are 2-pin NIC LED headers. Attach NIC LED cables to NIC1 and NIC2 LED indicators to display network activities. Refer to the table on the right for pin definitions.

LAN1/LAN2 LED Pin Definitions (JF1)	
Pin#	Definition
9/11	Vcc
10/12	Ground

**Overheat (OH)/Fan Fail**

Connect an LED cable to OH/Fan Fail connections on pins 7 and 8 of JF1 to provide warnings for chassis overheat/fan failure. Refer to the table on the right for pin definitions.

OH/Fan Fail LED Pin Definitions (JF1)	
Pin#	Definition
7	Vcc/Blue UID LED
8	OH/Fan Fail LED

OH/Fan Fail Indicator Status	
State	Definition
Off	Normal
On	Overheat
Flash-ing	Fan Fail

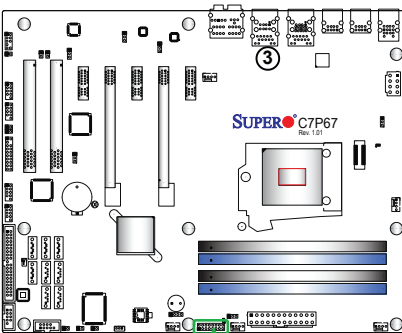

A. NIC1 LED

B. NIC2 LED

C. OH/Fan Fail

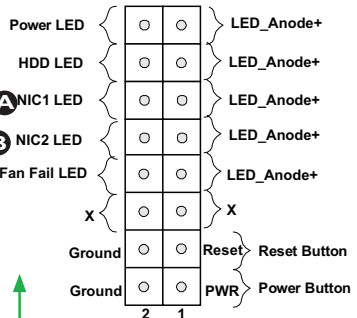



## Reset Button

The Reset Button connection is located on pins 3 and 4 of JF1. Attach it to a hardware reset switch on the computer case to reset the system. Refer to the table on the right for pin definitions.

Reset Button Pin Definitions (JF1)	
Pin#	Definition
3	Reset
4	Ground

## Power Button

The Power Button connection is located on pins 1 and 2 of JF1. Momentarily contacting both pins will power on/off the system. This button can also be configured to function as a suspend button (with a setting in the BIOS - see Chapter 4). To turn off the power in the suspend mode, press the button for at least 4 seconds. Refer to the table on the right for pin definitions.

Power Button Pin Definitions (JF1)	
Pin#	Definition
1	Signal
2	+3V Standby

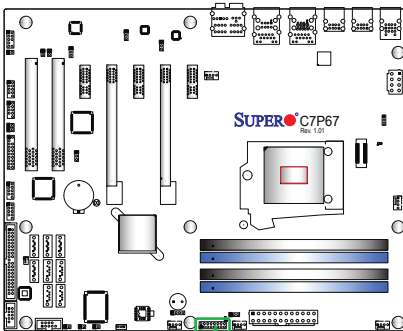

A. Reset Button

B. PWR Button

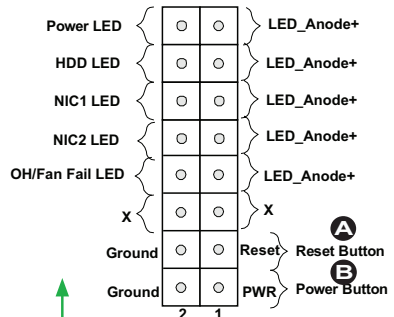

## 2-6 Connecting Cables

This section provides brief descriptions and pin-out definitions for onboard headers and connectors. Be sure to use the correct cable for each header or connector. For information on Backpanel USB and Front Panel USB ports, refer to Page 2-17. For Front Panel Audio, please refer to Page 2-19.

### ATX Main PWR & CPU PWR Connectors

The 24-pin main power connector (JPW1) is used to provide power to the motherboard. The 8-pin CPU PWR connector (JPW2) is also required for the processor. These power connectors meet the SSI EPS 12V specification. See the table on the right for pin definitions.

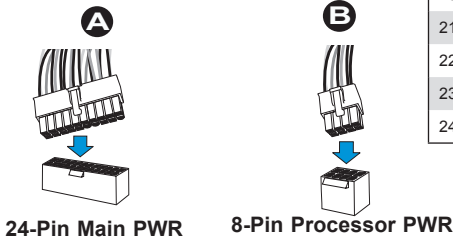

Pin#	Definition	Pin #	Definition
13	+3.3V	1	+3.3V
14	-12V	2	+3.3V
15	COM	3	COM
16	PS_ON	4	+5V
17	COM	5	COM
18	COM	6	+5V
19	COM	7	COM
20	Res (NC)	8	PWR_OK
21	+5V	9	5VSB
22	+5V	10	+12V
23	+5V	11	+12V
24	COM	12	+3.3V

Pins	Definition
1 through 4	Ground
5 through 8	+12V

(Required)

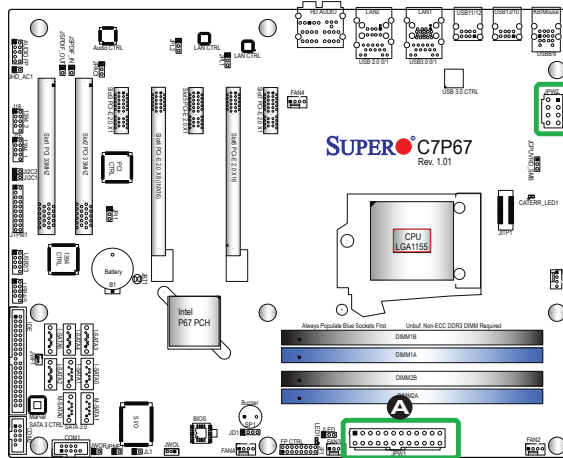

A. 24-Pin ATX Main PWR

B. 8-Pin Processor PWR

## Fan Headers

The C7P67 has five fan headers (Fan 1~Fan 4 and Fan A). These fans are 4-pin fan headers. However, Pins 1-3 of the fan headers are backward compatible with the traditional 3-pin fans (without fan speed control). A fan speed control setting in the BIOS Hardware Monitoring section allows the BIOS to automatically set fan speeds based on the system temperature. Refer to the table on the right for pin definitions.



**Note:** Please use all 3-pin fans or all 4-pin fans on a motherboard. Please do not use 3-pin fans and 4-pin fans on the same board.

Fan Header Pin Definitions	
Pin#	Definition
1	Ground (Black)
2	2.5A/+12V (Red)
3	Tachometer
4	PWM_Control

## Chassis Intrusion

A Chassis Intrusion header is located at JL1 on the motherboard. Attach the appropriate cable from the chassis to inform you of a chassis intrusion when the chassis is opened.

Chassis Intrusion Pin Definitions (JL1)	
Pin#	Definition
1	Intrusion Input
2	Ground

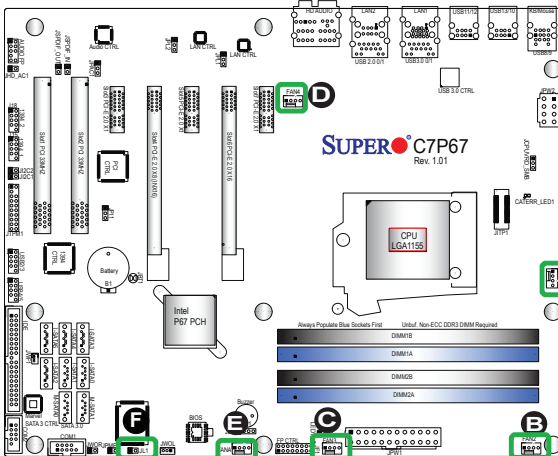

- A. Fan 1
- B. Fan 2
- C. Fan 3
- D. Fan 4
- E. Fan A
- F. Chassis Intrusion

**Internal Buzzer**

The Internal Buzzer (SP1) can be used to provide audible indications for various beep codes. See the table on the right for pin definitions.

Internal Buzzer Pin Definition		
Pin#	Definitions	
Pin 1	Pos. (+)	Beep In
Pin 2	Neg. (-)	Alarm Speaker

**Speaker**

On the JD1 header, Pins 3~4 are used for internal speaker. Close Pins 3~4 with a cap to use the onboard speaker. If you wish to use an external speaker, close Pins 1~4 with a cable. See the table on the right for pin definitions.

Speaker Connector Pin Definitions	
Pin Setting	Definition
Pins 3~4	Internal Speaker
Pins1~4	External Speaker

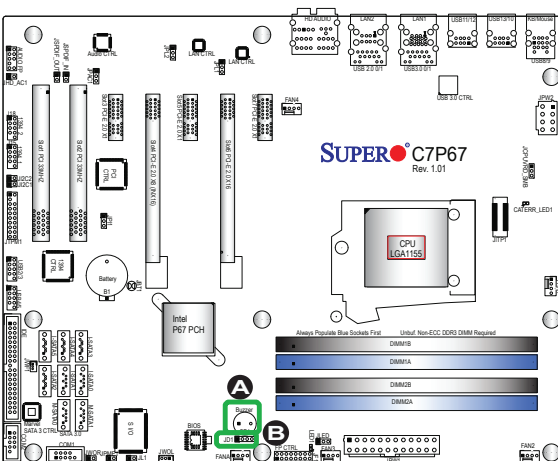

A. Internal Buzzer

B. Speaker Header

## IEEE 1394a\_1/ 1394a\_2 Connection

1394a\_1 (J15) and 1394a\_2 (J18) provide the IEEE 1394a connections on the motherboard. See the tables on the right for pin definitions.

1394_1 Pin Definitions			
Pin#	Definition	Pin#	Definition
1	PTPA0+	2	PTPA0-
3	GND	4	GND
5	PTPB0+	6	PTPB0-
7	PWR 1394a	8	PWR 1394a
		10	Shield GND

1394_2 Pin Definitions			
Pin#	Definition	Pin#	Definition
1	PTPA1+	2	PTPA1-
3	GND	4	GND
5	PTPB1+	6	PTPB1-
7	PWR 1394a	8	PWR 1394a
		10	Shield GND

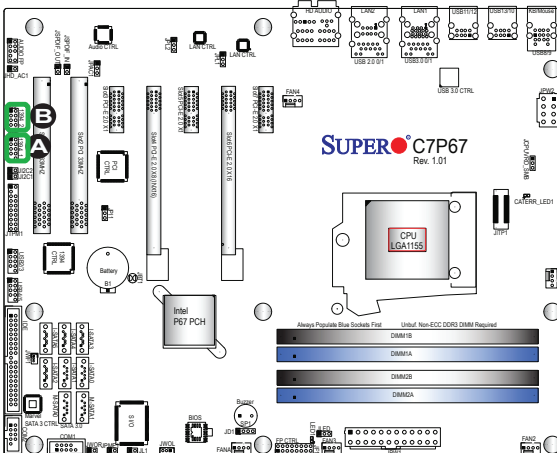

A. 1394a\_1

B. 1394a\_2

**Serial Ports**

Two COM connections (COM1 & COM2) are located on the motherboard. COM1 is located close to M-SATA ports 0/1. COM2 is located next to the IDE drive to provide additional onboard serial connection support. See the table on the right for pin definitions.

Serial Ports-COM1/COM2 Pin Definitions			
Pin #	Definition	Pin #	Definition
1	DCD	6	DSR
2	RXD	7	RTS
3	TXD	8	CTS
4	DTR	9	RI
5	Ground	10	N/A

**TPM Header/Port 80**

A Trusted Platform Module/Port 80 header is located at JTPM1 to provide TPM support and Port 80 connection. Use this header to enhance system performance and data security. See the table on the right for pin definitions.

TPM/Port 80 Header Pin Definitions			
Pin #	Definition	Pin #	Definition
1	LCLK	2	GND
3	LFRAME#	4	<(KEY)>
5	LRESET#	6	+5V (X)
7	LAD 3	8	LAD 2
9	+3.3V	10	LAD1
11	LAD0	12	GND
13	SMB_CLK4	14	SMB_DAT4
15	+3V_DUAL	16	SERIRQ
17	GND	18	CLKRUN# (X)
19	LPCPD#	20	LDRQ# (X)

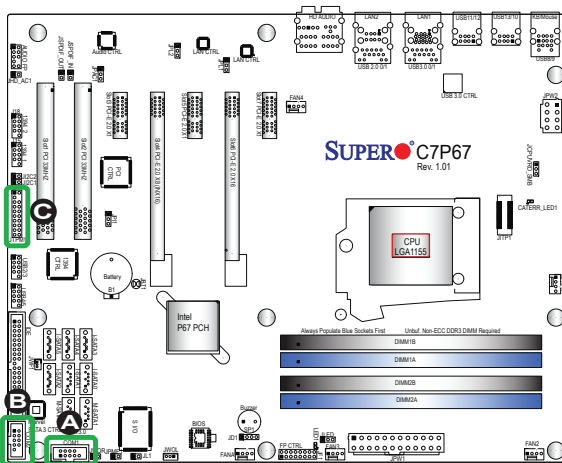

A. COM1

B. COM2

C. TPM/Port 80 Header

## DOM PWR Connector

The Disk-On-Module (DOM) power connector, located at JWF1, provides 5V (Gen1/Gen) power to a solid\_state DOM storage device connected to one of the SATA ports. See the table on the right for pin definitions.

DOM PWR Pin Definitions	
Pin#	Definition
1	5V
2	Ground
3	Ground

## Wake-On-LAN

The Wake-On-LAN header is located at JWOL on the motherboard. See the table on the right for pin definitions. (You must also have a LAN card with a Wake-On-LAN connector and cable to use this feature.)

Wake-On-LAN Pin Definitions (JWOL)	
Pin#	Definition
1	+5V Standby
2	Ground
3	Wake-up

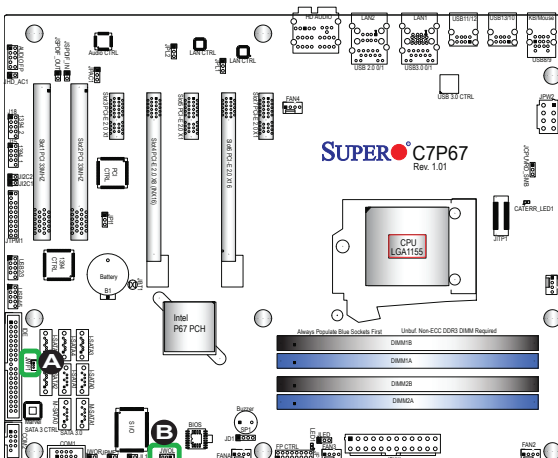

A. DOM PWR

B. WOL

**Wake-On-Ring**

The Wake-On-Ring header is located at JWOR. This function allows your computer to wake up when receiving an incoming call to the modem while in the suspend state. See the table on the right for pin definitions. You must have a Wake-On-Ring card and a cable to use this feature.

Wake-On-Ring Pin Definitions	
Pin#	Definition
1	Ground
2	Wake-up

**SPDIF\_In/SPDIF\_Out Headers**

The SPDIF\_In (JSPDIF\_In) and SPDIF\_Out (JSPDIF\_Out) are located between PCI Slot1 and Slot2. Place caps on these headers to use these features. You will also need the cables to use these features.

SPDIF_In Pin Definitions	
Pin#	Definition
1	S/PDIF_In
2	Ground

SPDIF_Out Pin Definitions	
Pin#	Definition
1	S/PDIF_Out
2	Ground

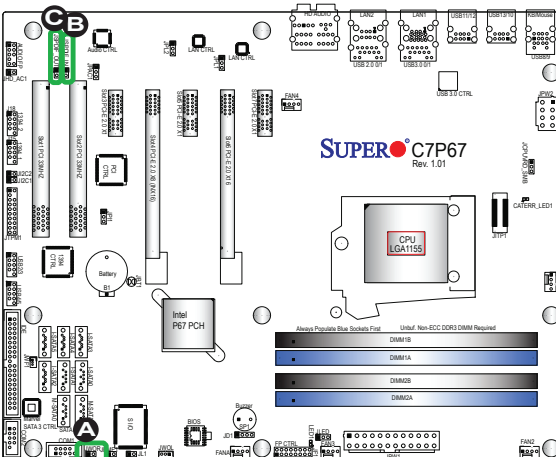

A. Wake\_On\_Ring

B. SPDIF\_In

C. SPDIF\_Out



## 2-7 Jumper Settings

### Explanation of Jumpers

To modify the operation of the motherboard, jumpers can be used to choose between optional settings. Jumpers create shorts between two pins to change the function of the connector. Pin 1 is identified with a square solder pad on the printed circuit board.

 **Note:** On two pin jumpers, "Closed" means the jumper is on, and "Open" means the jumper is off the pins.

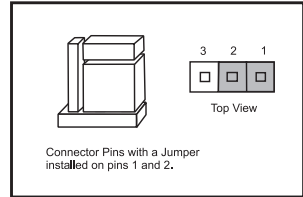
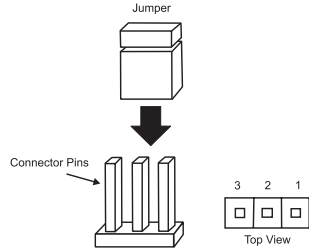

### LAN Port Enable/Disable

Jumpers JPL1/JPL2 enable or disable LAN Port 1/LAN Port 2 on the motherboard. See the table on the right for jumper settings. The default setting is enabled.

GLAN Enable Jumper Settings	
Pin#	Definition
1-2	Enabled (default)
2-3	Disabled

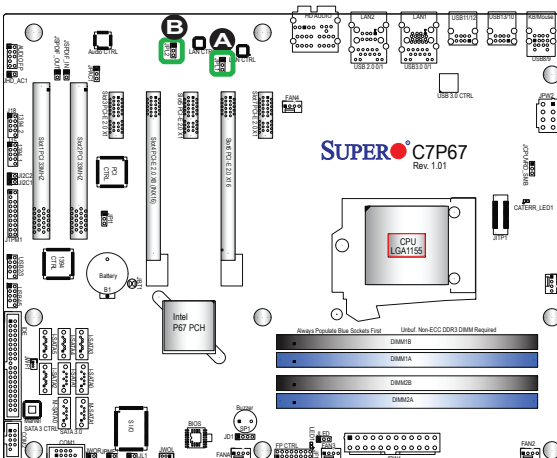

A. LAN Port 1 Enable

B. LAN Port 2 Enable

**CMOS Clear**

JBT1 is used to clear CMOS. Instead of pins, this "jumper" consists of contact pads to prevent accidental clearing of CMOS. To clear CMOS, use a metal object such as a small screwdriver to touch both pads at the same time to short the connection. Always remove the AC power cord from the system before clearing CMOS. (Ⓚ)

 **Note:** For an ATX power supply, you must completely shut down the system, remove the AC power cord and then short JBT1 to clear CMOS.

**PCI Slot SMB Enable**

Use Jumpers I<sup>2</sup>C1/I<sup>2</sup>C2 to enable PCI SMB (System Management Bus) support to improve system management for the PCI slots. See the table on the right for jumper settings.

PCI Slot_SMB Enable Jumper Settings	
Jumper Setting	Definition
On	Enabled
Off (Default)	Disabled

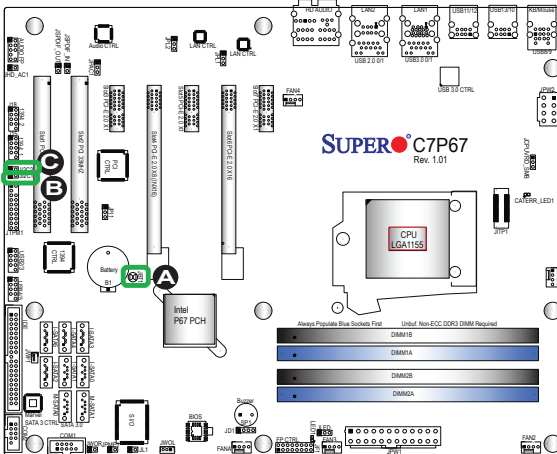

A. Clear CMOS

B. J12C1

C. J12C2

## Audio Enable

JPA1 allows you to enable or disable the onboard audio support. The default position is on pins 1 and 2 to enable on-board audio connections. See the table on the right for jumper settings.

Audio Enable/Disable Jumper Settings	
Both Jumpers	Definition
Pins 1-2	Enabled
Pins 2-3	Disabled

## IEEE 1394a Enable

JPI1 allows you to enable or disable the onboard IEEE 1394a support. The default position is on pins 1 and 2 to use 1394\_1 and 1394\_2 connections. See the table on the right for jumper settings.

1394a Enable/Disable Jumper Settings	
Both Jumpers	Definition
Pins 1-2	Enabled
Pins 2-3	Disabled

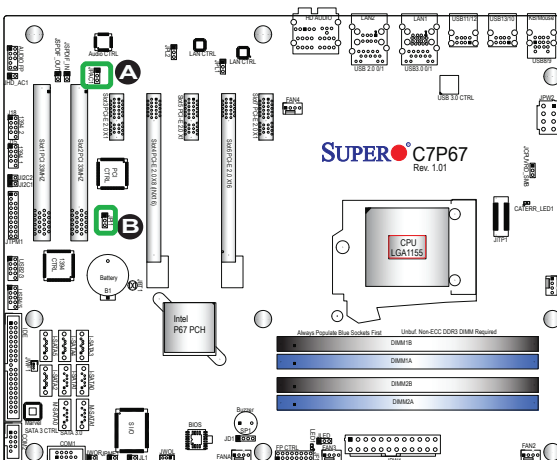

A. Audio Enable

B. WD Timer Enable

**ME Recovery Enable**

Close JPME1 to enable ME (Manufacture Mode) Recovery. See the table on the right for jumper settings.

ME Recovery Jumper Settings	
Settings	Definition
On	Enabled
Off	Normal (Default)

**HD FP Audio/AC' 97 FP Audio Select**

Jumper JHD\_AC1 allows the user to select between High-Definition Front Panel Audio and AC' 97 Front Panel Audio support. See the table on the right for jumper settings.

HD Audio/AC' 97 Audio Select Jumper Settings	
Settings	Definition
On	AC'97 Audio Front Panel
Off	HD Audio Front Panel (Default)

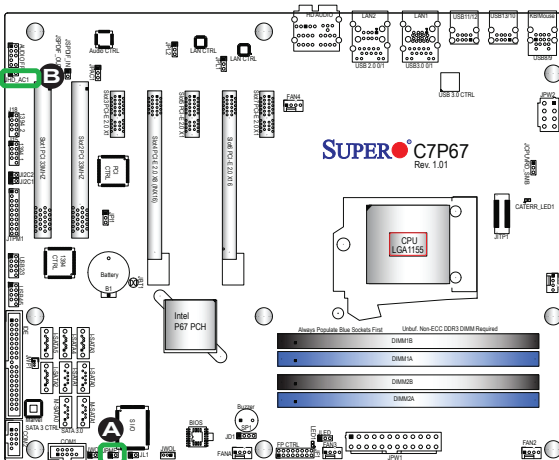

- A. ME Recovery
- B. HD Audio/AC'97 Audio Select

## 2-8 Onboard Indicators

### LAN 1/LAN 2 LEDs

Two LAN ports (LAN 1/LAN 2) are located on the I/O backplane of the motherboard. Each Ethernet LAN port has two LEDs. The yellow LED indicates activity, while the Link LED may be green, amber, or off to indicate the speed of the connections. See the tables at right for more information.

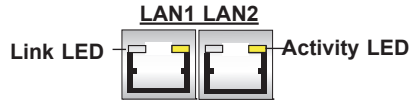

LAN 1/LAN 2 Link LEDs (Green/Amber/Off)	
LED Color	Definition
Off	No Connection or 10 Mbps
Green	100 Mbps
Amber	1 Gbps

### Onboard Power LED

An Onboard Power LED is located at LED1 on the motherboard. When LED1 is on, the AC power cable is connected. Make sure to disconnect the power cable before removing or installing any component. See the layout below for the LED location.

Onboard PWR LED Indicator LED Status	
Status	Definition
Off	System Off
On	System on, or System off and PWR Cable Connected

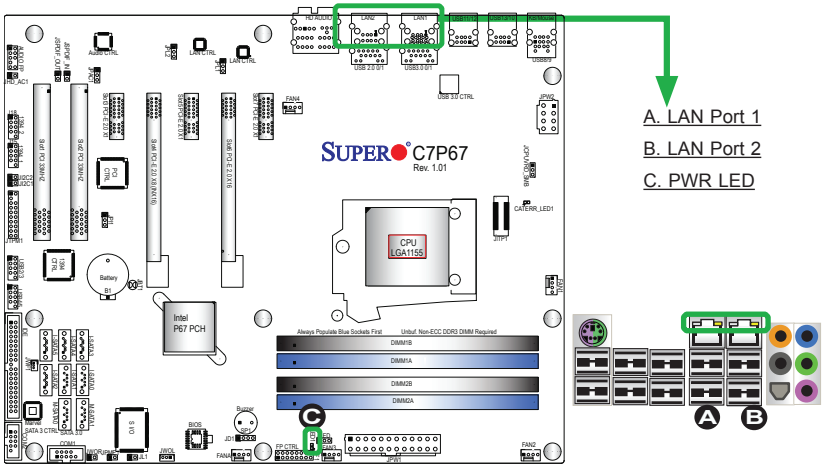

## 2-9 SATA Connections

Note the following conditions when connecting the Serial ATA disk drive cables:

- Be sure to use the correct cable for each connector. Refer to Page 1-1 for cables that came with your shipment.
- A red mark on a wire indicates the location of pin 1.

### SATA Connections

Four Serial ATA (SATA) 3.0 connectors (I-SATA 0/1, M-SATA 0/1) are located on the motherboard. In addition, four SATA 2.0 (I-SATA 2~5) connectors are also located on the board. The SATA 2.0 ports are supported by the Intel P67 PCH chip; while SATA 3.0 ports are supported by Intel PCH and Marvel SATA Controllers. These Serial Link connections provide faster data transmission than legacy Parallel ATA. See the table on the right for pin definitions.

C7P67 SATA Connector Types			
Port#	Connection Type	Port#	Connection Type
I-SATA 0/1, M-SATA 0/1	SATA 3.0	I-SATA 2~5	SATA 2.0

SATA 2.0/3.0 Connectors Pin Definitions	
Pin#	Signal
1	Ground
2	SATA_TXP
3	SATA_TXN
4	Ground
5	SATA_RXN
6	SATA_RXP
7	Ground

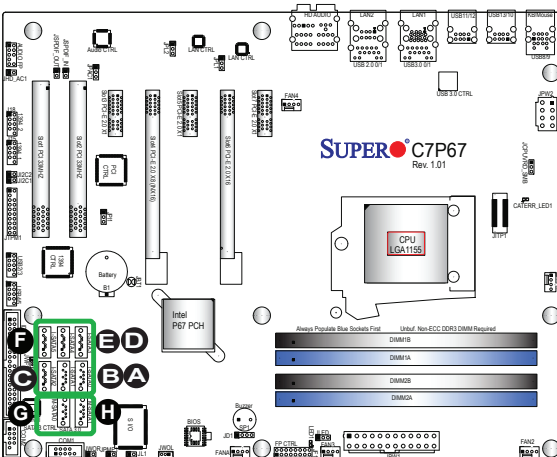

- A. I-SATA 3.0 #0
- B. I-SATA 3.0 #1
- C. I-SATA 2.0 #2
- D. I-SATA 2.0 #3
- E. I-SATA 2.0 #4
- F. I-SATA 2.0 #5
- G. M-SATA 3.0 #0
- H. M-SATA 3.0 #1

## IDE Connector

AN IDE Connector is located on the motherboard. This connector can be used for a Compact Flash card. See the table on the right for pin definitions.

IDE Drive Connector Pin Definitions			
Pin#	Definition	Pin #	Definition
1	Reset IDE	2	Ground
3	Host Data 7	4	Host Data 8
5	Host Data 6	6	Host Data 9
7	Host Data 5	8	Host Data 10
9	Host Data 4	10	Host Data 11
11	Host Data 3	12	Host Data 12
13	Host Data 2	14	Host Data 13
15	Host Data 1	16	Host Data 14
17	Host Data 0	18	Host Data 15
19	Ground	20	Key
21	DRQ3	22	Ground
23	I/O Write	24	Ground
25	I/O Read	26	Ground
27	IOCHRDY	28	BALE
29	DACK3	30	Ground
31	IRQ14	32	IOCS16
33	Addr1	34	Ground
35	Addr0	36	Addr2
37	Chip Select 0	38	Chip Select 1
39	Activity	40	Ground

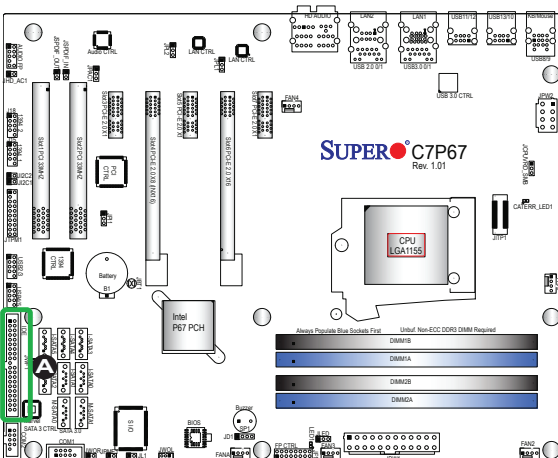

A. IDE

## Notes



## Chapter 3

# Troubleshooting

### 3-1 Troubleshooting Procedures

Use the following procedures to troubleshoot your system. If you have followed all of the procedures below and still need assistance, refer to the 'Technical Support Procedures' and/or 'Returning Merchandise for Service' section(s) in this chapter. Always disconnect the AC power cord before adding, changing or installing any hardware components.

#### Before Power On

1. Make sure that the Standby PWR LED (LED1) is not on. (**Note:** If LED1 is on, the onboard power is on. Be sure to unplug the power cable before installing or removing the components.)
2. Make sure that there are no short circuits between the motherboard and chassis.
3. Disconnect all ribbon/wire cables from the motherboard, including those for the keyboard and mouse. Also, be sure to remove all add-on cards.
4. Install a CPU and heatsink (-be sure that it is fully seated) and then connect the chassis speaker and the power LED to the motherboard. Check all jumper settings as well.

#### No Power

1. Make sure that there are no short circuits between the motherboard and chassis.
2. Make sure that all jumpers are set to their default positions.
3. Check if the 115V/230V switch on the power supply is properly set.
4. Turn the power switch on and off to test the system.
5. The battery on your motherboard may be old. Check to make sure that it still supplies ~3VDC. If it does not, replace it with a new one.

## **No Video**

1. If the power is on, but you have no video--in this case, you will need to remove all the add-on cards and cables first.
2. Use the speaker to determine if any beep codes exist. (Refer to Appendix A for details on beep codes.)
3. Remove all memory modules and turn on the system. (If the alarm is on, check the specs of memory modules, reset the memory or try a different one.)

## **Memory Errors**

1. Make sure that the DIMM modules are properly installed and fully seated in the slots.
2. You should be using unbuffered Non-ECC DDR3 (1.5V) 1333/1066 MHz memory (recommended by the manufacturer). Also, it is recommended that you use the memory modules of the same type and speed for all DIMMs in the system. Do not use memory modules of different sizes, different speeds and different types on the same motherboard.
3. Check for bad DIMM modules or slots by swapping modules between slots to see if you can locate the faulty ones.
4. Check the switch of 115V/230V power supply.

## **Losing the System's Setup Configuration**

1. Please be sure to use a high quality power supply. A poor quality power supply may cause the system to lose CMOS setup information. Refer to Section 1-5 for details on recommended power supplies.
2. The battery on your motherboard may be old. Check to verify that it still supplies ~3VDC. If it does not, replace it with a new one.
3. If the above steps do not fix the Setup Configuration problem, contact your vendor for repairs.

## **3-2 Technical Support Procedures**

Before contacting Technical Support, please make sure that you have followed all the steps listed below. Also, Note that as a motherboard manufacturer, Supermicro

does not sell directly to end users, so it is best to first check with your distributor or reseller for troubleshooting services. They should know of any possible problem(s) with the specific system configuration that was sold to you.

1. Please go through the 'Troubleshooting Procedures' and 'Frequently Asked Question' (FAQ) sections in this chapter or see the FAQs on our website (<http://www.supermicro.com/support/faqs/>) before contacting Technical Support.
2. BIOS upgrades can be downloaded from our website at (<http://www.supermicro.com/support/bios/>).



**Note:** Not all BIOS can be flashed. Some cannot be flashed; it depends on the boot block code of the BIOS.

3. If you've followed the instructions above to troubleshoot your system, and still cannot resolve the problem, then contact Supermicro's technical support and provide them with the following information:
  - Motherboard model and PCB revision number
  - BIOS release date/version (this can be seen on the initial display when your system first boots up)
  - System configuration
  - An example of a Technical Support form is on our website at (<http://www.supermicro.com/support/contact.cfm>).
4. Distributors: For immediate assistance, please have your account number ready when placing a call to our technical support department. We can be reached by e-mail at [support@supermicro.com](mailto:support@supermicro.com), by phone at: (408) 503-8000, option 2, or by fax at (408)503-8019.

### 3-3 Frequently Asked Questions

**Question:** What type of memory does my motherboard support?

**Answer:** The C7P67 supports up to 32GB of unbuffered Non-ECC DDR3 SDRAM (1.5V, 1333/1066 MHz). See Section 2-3 for details on installing memory.

**Question:** How do I update my BIOS?

**Answer:** We do NOT recommend that you upgrade your BIOS if you are not experiencing any problems with your system. Updated BIOS files are located on

---

our website at <http://www.supermicro.com/support/bios/>. Please check our BIOS warning message and the information on how to update your BIOS on our web site. Select your motherboard model and download the BIOS ROM file to your computer. Also, check the current BIOS revision to make sure that it is newer than your BIOS before downloading. You may choose the zip file or the .exe file. If you choose the zipped BIOS file, please unzip the BIOS file onto a bootable device or a USB pen/thumb drive. To flash the BIOS, run the batch file named "ami.bat" with the new BIOS ROM file from your bootable device or USB pen/thumb drive. Use the following format:

```
F:\> ami.bat BIOS-ROM-filename.xxx <Enter>
```



**Note:** Always use the file named "ami.bat" to update the BIOS, and insert a space between "ami.bat" and the filename. The BIOS-ROM-filename will bear the motherboard name (i.e., C7P67) and build version as the extension. For example, "C7P670.115". When completed, your system will automatically reboot.

If you choose the .exe file, please run the .exe file under Windows to create the BIOS flash floppy disk. Insert the floppy disk into the system you wish to flash the BIOS. Then, boot the system to the floppy disk. The BIOS utility will automatically flash the BIOS without any prompts. Please note that this process may take a few minutes to complete. Do not be concerned if the screen is paused for a few minutes.

When the BIOS flashing screen is completed, the system will reboot and will show "Press F1 or F2". At this point, you will need to load the BIOS defaults. Press <F1> to go to the BIOS setup screen, and press <F9> to load the default settings. Next, press <F10> to save and exit. The system will then reboot.

**Warning:** Do not shut down or reset the system while updating the BIOS to prevent possible system boot failure!



**Note:** The SPI BIOS chip installed on this motherboard is not removable. To repair or replace a damaged BIOS chip, please send your motherboard to RMA at Supermicro for service.

**Question:** I think my BIOS is corrupted. How can I recover my BIOS?

**Answer:** Please see Appendix C-BIOS Recovery for detailed instructions.

**Question:** What's on the CD that came with my motherboard?

**Answer:** The supplied compact disc has quite a few drivers and programs that will greatly enhance your system. We recommend that you review the CD and install the applications you need. Applications on the CD include chipset drivers for Windows, security programs, and audio drivers.

**Question:** Why do I get an error message "IASTOR.SYS read error" and "press F6 to install Intel RAID driver" when installing Windows on my motherboard?

**Answer:** To solve this issue, disable the IPMI jumper. Another solution is to use a USB floppy drive instead of the onboard floppy drive. For the IPMI jumper location, please check Chapter 1.

**Question:** What is the heatsink part number for my C7P67 motherboard?

**Answer:** For the 1U passive heatsink, ask for SNK-P0046P (back plate is included). For the 2U active heatsink, use SNK-P0046A4.

**Question:** Why can't I recover the BIOS even when I've followed the instructions in the user's manual for the motherboard?

**Answer:** Please disable the IPMI jumper and try it again. For the jumper location, please check Chapter 1.

## 3-4 Battery Removal and Installation

### Battery Removal

To remove the onboard battery, follow the steps below:

1. Power off your system and unplug your power cable.
2. Locate the onboard battery as shown below.
3. Using a tool such as a pen or a small screwdriver, push the battery lock outwards to unlock it. Once unlocked, the battery will pop out from the holder.
4. Remove the battery.

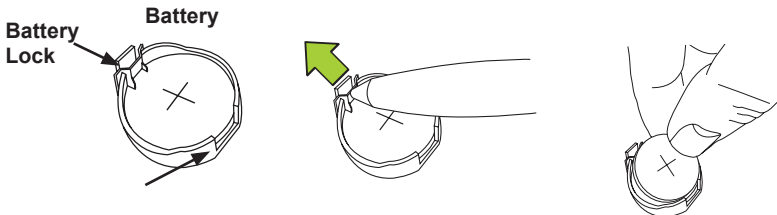

### Proper Battery Disposal



**Warning!** Please handle used batteries carefully. Do not damage the battery in any way; a damaged battery may release hazardous materials into the environment. Do not discard a used battery in the garbage or a public landfill. Please comply with the regulations set up by your local hazardous waste management agency to dispose of your used battery properly.

## Battery Installation

1. To install an onboard battery, follow the steps 1& 2 above and continue below:
2. Identify the battery's polarity. The positive (+) side should be facing up.
3. Insert the battery into the battery holder and push it down until you hear a click to ensure that the battery is securely locked.

 **Warning:** When replacing a battery, be sure to only replace it with the same type.

### Battery Holder

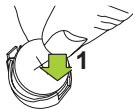
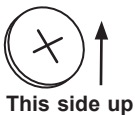

## 3-5 Returning Merchandise for Service

A receipt or copy of your invoice marked with the date of purchase is required before any warranty service will be rendered. You can obtain service by calling your vendor for a Returned Merchandise Authorization (RMA) number. For faster service, you may also obtain RMA authorizations online (<http://www.supermicro.com/support/rma/>). When you return the motherboard to the manufacturer, the RMA number should be prominently displayed on the outside of the shipping carton, and mailed prepaid or hand-carried. Shipping and handling charges will be applied for all orders that must be mailed when service is complete.

This warranty only covers normal consumer use and does not cover damages incurred in shipping or from failure due to the alteration, misuse, abuse or improper maintenance of products.

During the warranty period, contact your distributor first for any product problems.

---

## Chapter 4

### BIOS

#### 4-1 Introduction

This chapter describes the AMI BIOS Setup Utility for the C7P67. The AMI ROM BIOS is stored in a Flash EEPROM and can be easily updated. This chapter describes the basic navigation of the AMI BIOS Setup Utility setup screens.

 **Note:** For AMI BIOS Recovery, please refer to the UEFI BIOS Recovery Instructions listed in Appendix C.

#### Starting BIOS Setup Utility

To enter the AMI BIOS Setup Utility screens, press the <Delete> key while the system is booting up.

 **Note:** In most cases, the <Delete> key is used to invoke the AMI BIOS setup screen. There are a few cases when other keys are used, such as <F1>, <F2>, etc.

Each main BIOS menu option is described in this manual. The Main BIOS setup menu screen has two main frames. The left frame displays all the options that can be configured. Grayed-out options cannot be configured. Options in blue can be configured by the user. The right frame displays the key legend. Above the key legend is an area reserved for a text message. When an option is selected in the left frame, it is highlighted in white. Often a text message will accompany it.

 **Note:** the AMI BIOS has default text messages built in. Supermicro retains the option to include, omit, or change any of these text messages.

The AMI BIOS Setup Utility uses a key-based navigation system called "hot keys". Most of the AMI BIOS setup utility "hot keys" can be used at any time during the setup navigation process. These keys include <F1>, <F10>, <Enter>, <ESC>, arrow keys, etc.

 **Note:** Options printed in **Bold** are default settings.

#### How To Change the Configuration Data

The configuration data that determines the system parameters may be changed by entering the AMI BIOS Setup utility. This Setup utility can be accessed by pressing <Del> at the appropriate time during system boot.

## How to Start the Setup Utility

Normally, the only visible Power-On Self-Test (POST) routine is the memory test. As the memory is being tested, press the <Delete> key to enter the main menu of the AMI BIOS Setup Utility. From the main menu, you can access the other setup screens. An AMI BIOS identification string is displayed at the left bottom corner of the screen, below the copyright message.

**Warning!** Do not upgrade the BIOS unless your system has a BIOS-related issue. Flashing the wrong BIOS can cause irreparable damage to the system. In no event shall Supermicro be liable for direct, indirect, special, incidental, or consequential damages arising from a BIOS update. If you have to update the BIOS, do not shut down or reset the system while the BIOS is updating. This is to avoid possible boot failure.

## 4-2 Main Setup

When you first enter the AMI BIOS Setup Utility, you will enter the Main setup screen. You can always return to the Main setup screen by selecting the Main tab on the top of the screen. The Main BIOS Setup screen is shown below.

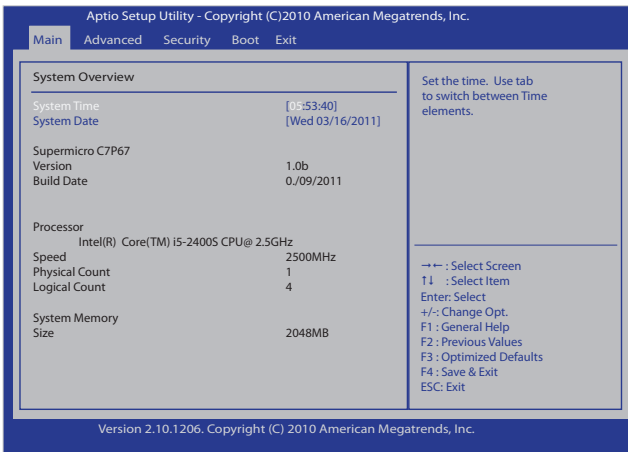



### System Time/System Date

Use this option to change the system time and date. Highlight *System Time* or *System Date* using the arrow keys. Key in new values through the keyboard and press <Enter>. Press the <Tab> key to move between fields. The date must be entered in MM/DD/YY format. The time is entered in HH:MM:SS format.

 **Note:** The time is in the 24-hour format. For example, 5:30 P.M. appears as 17:30:00.

The following BIOS items will also be displayed:

- **Supermicro C7P67**
- **Version:** This item displays the BIOS revision used in your system.
- **Build Date:** This item displays the date when this BIOS was completed.

### Processor

The AMI BIOS will automatically display the status of the processor used in your system:

- **CPU Type:** This item displays the type of CPU used in the motherboard.
- **Speed:** This item displays the speed of the CPU detected by the BIOS.
- **Physical Count:** This item displays the number of processors installed in your system as detected by the BIOS.
- **Logical Count:** This item displays the number of CPU Cores installed in your system as detected by the BIOS.

### System Memory

- **Size:** This displays the size of memory available in the system.

## 4-3 Advanced Setup Configurations

Use the arrow keys to select Boot Setup and press <Enter> to access the submenu items:

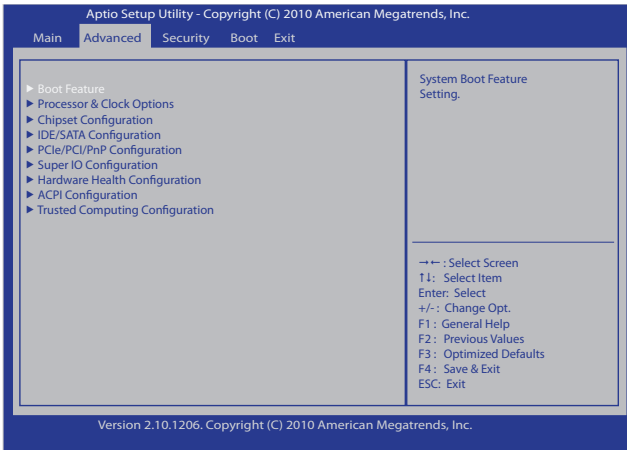

### ► Boot Feature

#### Quiet Boot

This option allows the user to select the bootup screen display between POST messages or the OEM logo. Select Disabled to display the POST messages. Select Enabled to display the OEM logo instead of the normal POST messages. The options are **Enabled** and Disabled.

#### AddOn ROM Display Mode

Use this feature to configure Option ROM mode settings. The options are **Force BIOS** and Keep Current.

#### Bootup Num-Lock

This feature selects the Power-on state for the Numlock key. Select On to enable the Num-Lock key at bootup. The options are Off and **On**.

#### Wait For 'F1' If Error

This forces the system to wait until the 'F1' key is pressed if an error occurs. The options are Disabled and **Enabled**.

#### Interrupt 19 Capture

Interrupt 19 is the software interrupt that handles the boot disk function. When this item is set to Enabled, the ROM BIOS of the host adaptors will "capture" Interrupt 19 at bootup and allow the drives that are attached to these host adaptors to function as bootable disks. If this item is set to Disabled, the ROM BIOS of the host adap-

---

tors will not capture Interrupt 19, and the drives attached to these adaptors will not function as bootable devices. The options are **Enabled** and Disabled.

## Power Configuration

### Power Button Function

If this item is set to Instant\_Off, the system will power off immediately as soon as the user presses the power button. If set to 4\_Second\_Override, the system will power off when the user presses the power button for 4 seconds or longer. The options are **Instant\_Off** and 4\_Second\_Override.

### Restore on AC Power Loss

Use this feature to set the power state after a power outage. Select Power-Off for the system power to remain off after a power outage. Select Power-On for the system power to be turned on after a power outage. Select Last State to allow the system to resume its last power state before a power outage. The options are Power-On, Power-Off and **Last State**.

## ► Processor & Clock Options

 **Warning:** Take Caution when changing the Advanced settings. An incorrect value, a very high DRAM frequency or an incorrect DRAM timing setting may cause system to become unstable. When this occurs, revert the item to the manufacture default setting.

This submenu displays the status of the processor used in the motherboard and allows the user to configure the Processor and Clock settings.

- **Type of the CPU:** This item displays the CPU type for the motherboard.
- **Frequency:** This item displays the CPU frequency for the motherboard.
- **CPUID:** This item displays the CPUID for the motherboard.
- **Microcode Revision:** This item displays the CPUID for the motherboard.
- **Cache L1:** This item displays the size of Cache L1 of the CPU for the motherboard.
- **Cache L2:** This item displays the size of Cache L2 of the CPU for the motherboard.
- **Cache L3:** This item displays the size of Cache L3 of the CPU for the motherboard.

- **Ratio Status:** This item displays the status of the CPU ratio.
- **Ratio Actual Value:** This item displays the actual value of the CPU ratio.

#### **Hardware Prefetcher (Available when supported by the CPU)**

If set to Enabled, the hardware prefetcher will prefetch streams of data and instructions from the main memory to the L2 cache in the forward or backward manner to improve CPU performance. The options are Disabled and **Enabled**.

#### **Adjacent Cache Line Prefetch (Available when supported by the CPU)**

If this feature set to Enabled, the CPU prefetches both cache lines for 128 bytes as comprised. If this feature is set to Disabled, the CPU prefetches the cache line for 64 bytes. The options are **Enabled** and Disabled

#### **Intel® Virtualization Technology (Available when supported by the CPU)**

Select Enabled to use the feature of Virtualization Technology to allow one platform to run multiple operating systems and applications in independent partitions, creating multiple "virtual" systems in one physical computer. The options are **Enabled** and Disabled.

 **Note:** If there is any change to this setting, you will need to reboot the system for the change to take effect. Please refer to Intel's website for detailed information.

#### **Execute-Disable Bit Capability (Available when supported by the OS and the CPU)**

Select Enabled to enable Execute Disable Bit support which will allow the processor to designate areas in the system memory where an application code can execute and where it cannot, thus preventing a worm or a virus from flooding illegal codes to overwhelm the processor or damage the system during an attack. The default is **Enabled**. (Refer to Intel and Microsoft Web Sites for more information.)

#### **Intel® AES-NI**

Select Enabled to enable Advanced Encryption Standard support for the processor. The options are **Disabled** and Enabled.

#### **Active Processor Cores**

Set to Enabled to use a processor's Second Core and beyond. (Refer to Intel's website for more information.) The options are **All**, 1 and 2.

## Power Technology

Use the features below to select system power management settings. Select Energy Efficient to minimize power use. Select Custom to customize power use settings. The options are Disabled, **Energy Efficient** and Custom. When this item is set to Custom, the following items will display:

### EIST

EIST (Enhanced Intel SpeedStep Technology) allows the system to automatically adjust processor voltage and core frequency in an effort to reduce power consumption and heat dissipation. **Please refer to Intel's web site for detailed information.** The options are Disabled and **Enabled**.

### P-STATE Coordination

This feature selects the type of coordination for the P-State of the processor. P-State is a processor operational state that reduces the processor's voltage and frequency. This makes the processor more energy efficient, resulting in further energy gains. The options are **HW\_ALL**, SW\_ALL and SW-ANY.

### CPU C3 Report

Select Enabled for the CPU to report C3 (ACPI C2) state to the operating system. The options are **Disabled** and Enabled.

### CPU C6 Report

Select Enabled for the CPU to report C6 (ACPI C3) state to the operating system. The options are Disabled and **Enabled**.

### Package C-State limit

Select Auto for the AMI BIOS to automatically set the limit on the C-State package register. The options are **C0**, C1, C6, C7 and No Limit.

## ► Turbo Boost Technology

### TurboMode

Select Enabled to allow processor cores to run faster than the frequency marked in the manufacture specifications. The options are Disabled and **Enabled**.

### Factory Long-Duration Power Limit

This feature displays the power limit set by the manufacturer for long-term power use.

### Long-Duration Power Limit

This feature displays the current limit setting for long-term power use.

### **Factory Long-Duration Maintained**

This feature displays the long-term power maintenance setting set by the manufacturer.

### **Long-Duration Maintained**

This feature displays the long-term power maintenance setting currently set for this system.

### **Recommended Short-Duration Power Limit**

This feature displays the power limit recommended by the manufacturer for short-term power use. The default setting is 1.25\* Long Duration (that means, 1.25 times the value of Long-Duration Power Limit indicated above.)

### **Short-Duration Power Limit**

This feature displays the power limit set by the manufacturer for short-term power use.

### **Base Frequency**

This feature displays the status of based frequency of the system.

#### **1-Core Ratio Limit/2-Core Ratio Limit/3-Core Ratio Limit/4-Core Ratio Limit**

This increases (multiplies) a processor's core 1 clock speed in relation to the bus speed of a processor specified by the user. Press "+" or "-" on your keyboard to change this value.

## **► Chipset Configuration**

The items included in the Advanced Settings submenu are listed below.

### **► CPU Bridge Configuration**

The following CPU Bridge submenu items are listed below.

- **CPU Revision:** This item displays the CPU revision used in the system.
- **Current CPU1 Memory Frequency:** This item displays the status of current CPU1 memory frequency.
- **Memory Type:** This item displays the memory type used in the system.
- **Memory Reference Code Revision:** This item displays the revision number of the memory reference code of the CPU used in the system.

### Memory Frequency

Use this feature to force the system memory to run at a different frequency from the frequency specified by the memory module. The options are **Auto**, Force DDR-800, Force DDR-1066, Force DDR-1333 and Force DDR-1600.

### Performance Tuner

This feature allows the user to the BIOS settings to improve CPU performance.

### Intel Extreme Memory Profile (X.M.P)

Select Enable to support Intel Extreme Memory Profile technology to improve CPU performance. The options are **Disabled** and Enabled.

## ► DRAM Timing

This feature allows the user to set aggressive DRAM timing settings to improve system performance.

### DRAM CAS Latency (tCL)

This item displays the DRAM CAS (Column Address Strobe) Latency time, which is the time delay between the moment when the memory controller tells a memory module to access a column address on the module and the moment when the data of the column address becomes available for output. Generally, memory modules with lower latency performs better than those with higher latency. The range of DRAM CAS latency is between 0~12ns, and the step (increment) is 1ns. The default setting is **Auto**.

### DRAM RAS to CAS Delay (tRCD)

This item displays the delay time needed from Row Address Strobe (RAS) to Column Address Strobe (CAS). It is the number of clock cycles needed from the moment when the computer defines the row and column block of a memory module to the moment when read and write actually takes place in the same memory block. Generally, the shorter the DRAM RAS-to-CAS Delay is the better the memory performance is. The range of DRAM RAS-to-CAS Delay is between 0~12ns, and the step (increment) is 1ns. The default setting is **Auto**.

### DRAM RAS Precharge Delay (tRP)

This item displays the delay time (or the number of clock cycles) needed for the system to disengage from a open row of a memory module to start accessing the next row on the same memory module. This stands for ROW Precharge time. Generally, the shorter the DRAM RAS Precharge Delay is the better the memory performance is. The range of DRAM RAS Precharge Delay is between 0~12ns, and the step (increment) is 1ns. The default setting is **Auto**.

---

### **DRAM Active to Precharge Delay (tRAS)**

This item displays the minimum number of clock cycles needed for the system to access a certain row of data in a memory module between the time when data request is made and the time when the precharge command is completed. The range of DRAM Active to Precharge Delay is between 0~34ns, and the step (increment) is 1ns. The default setting is **Auto**.

## **►System Voltage**

This feature displays system voltage settings.

### **Memory Voltage (mv)**

This item displays the status of the memory voltage. The range of the memory voltage is between 1.500v~1.800v, and the step (increment) is 0.010v. The default setting is **1.500v**.

### **Processor I/O Voltage (mv)**

This item displays the status of the processor I/O voltage. The range of the processor I/O voltage is between 1.050v~1.110v, and the step (increment) is 0.010v. The default setting is **1.050v**.

### **PCH Voltage (mv)**

This item displays the status of the PCH voltage. The range of the PCH voltage is between 1.050v~1.110v, and the step (increment) is 0.020v. The default setting is **1.050v**.

## **►System Agent Configuration**

The following System Agent submenu items are listed below.

- **System Agent Revision:** This item displays the revision number of the System Agent chip used in this system.

### **VT-d**

Select Enabled to enable Intel Virtualization Technology support for Direct I/O VT-d by reporting the I/O device assignments to VMM through the DMAR ACPI Tables. This feature offers fully-protected I/O resource-sharing across the Intel platforms, providing the user with greater reliability, security and availability in networking and data-sharing. The settings are Enabled and **Disabled**.

### **PCI Express Port**

Select Enabled to enable onboard PCI-Express support. Select Auto for the system to automatically enable PCI-E support when a PCI-E device is detected



and to disable PCI-E support when no PCI-E device is detected. The options are Enabled, Disabled, and **Auto**.

### **PEG Force Gen1**

Select Enabled to downgrade PCI-Express connections to support PCI-E Generation 1 devices. The options are **Disabled** and Enabled.

### **Detect Non-Compliance Device**

Select Enabled for the system to automatically detect if a non-compliance PCI-Express device, which is not compatible to onboard PCI-E support, has been installed in a PCI-E slot. The options are **Disabled** and Enabled.

## **► South Bridge Configuration**

The following South Bridge submenu items are listed below.

- **South Bridge Revision:** This item displays the revision number of the South Bridge chip used in this system.

### **Legacy USB Support**

Select Enabled to use Legacy USB devices. If this item is set to Auto, Legacy USB support will be automatically enabled if a legacy USB device is detected on the motherboard, and vice versa. The options are Disabled, **Enabled** and Auto.

### **Port60h/64h Emulation**

Select Enabled to enable 60h/64h emulation for complete USB keyboard support for operating systems that are not compatible with USB devices. The options are **Enabled** and Disabled.

### **BIOS EHCI Hand-Off**

Select Enabled to enable BIOS Enhanced Host Controller Interface support to provide a workaround solution for an operating system that does not have EHCI Hand-Off support. When enabled, the EHCI Interface will be changed from the BIOS-controlled to the OS-controlled. The options are Disabled and **Enabled**.

### **Azalia HD Audio**

Select Enabled to support Azalia High-Definition Audio devices. The options are Disabled and **Enabled**.

### **Frontside Audio Mode**

Use this feature to select the audio mode for the front-side audio devices. The options are **HD Audio** and AC'97.

## Deep Sx

Use this feature to configure the power state of the system when it is in the deep sleep state. Please note that the deep S4/S5 state is supported in DC only for mobile systems. The deep S4/S5 state is supported in AC only for desktop systems. The options are **Disabled**, Enabled in S5, and Enabled in S4 and S5.

## ► Onboard Chip Configuration

This submenu allows the user to configure Onboard Chip settings.

### USB 3.0 Legacy Support

Select Enabled to support USB 3.0 Expansable\_Host\_Controller\_Interface (XHCI). The options are **Disabled** and Enabled. If this feature is set to Enabled, the following item will display:

#### **XHCI Hand-off**

Select Enabled to enable Expansible Host Controller Interface (XHCI) support to provide a workaround solution for an operating system that does not have XHCI Hand-Off support. When enabled, the XHCI Interface will be changed from the BIOS-controlled to the OS-controlled. The options are Disabled and **Enabled**.

---

## ► IDE /SATA Configuration

When this submenu is selected, the AMI BIOS automatically detects the presence of the IDE/SATA Devices and displays the following items:

### **SATA Mode**

This feature allows the user to configure the SATA mode for a drive specified. The options are **IDE Mode**, AHCI Mode, RAID Mode and Disabled.

- When the option-IDE Mode is select, the following items will display:

#### **Serial-ATA Controller 0**

This feature allows the user to set the serial\_link mode for SATA Controller 0. The options are Disabled, Enhanced and **Compatible**.

#### **Serial-ATA Controller 1**

This feature allows the user to set the serial\_link mode for SATA Controller 1. The options are Disabled and **Enhanced**.

#### **SATA Port0~ SATA Port5**

The AMI BIOS will automatically display the status of a SATA port if a device is detected in the SATA port specified.

- When the option-AHCI (Advanced Host Controller Interface) Mode is select, the following items will display:

#### **Aggressive Link Power Management**

Select Enabled to support Aggressive Link Power Management to provide a Cougar Point B0 or newer chip with advanced power functionality support. The options are Disabled and **Enabled**.

#### **SATA Port0~ SATA Port4**

The AMI BIOS will automatically detect the presence of a device installed in a SATA port specified by a user, and displays the following items for configuration if a device is present.

#### **Staggered Spin-up**

Select Enabled for the AHCI Controller to support Staggered Spin-up, which will allow system devices to spin-up one at a time to prevent sudden, excessive power-consumption, resulting in a power shortage. The options are Enabled and **Disabled**.

### Hot-Plug

Select Enabled to enable hot-plug support for a SATA device installed in a SATA port specified by the user. The options are Enabled and **Disabled**.

- When the option-RAID Mode is selected, the following items will appear.

### SATA Port0~ SATA Port5

The AMI BIOS will automatically detect the presence of a device installed in a SATA port specified by a user, and displays the following items for configuration.

### Hot-Plug

Select Enabled to enable hot-plug support for a SATA device installed in a SATA port specified by the user. The options are Enabled and **Disabled**.

## ►PCIe/PCI/PnP Configuration

This feature allows the user to configure the PCIe (PCI-Express)/PCI/PnP (Play and Plug) settings for the following items:

### PCI Latency Timer

This feature sets the latency Timer of each PCI device installed on a PCI bus. Select 64 to set the PCI latency to 64 PCI clock cycles. The options are 32, **64**, 96, 128, 160, 192, 224 and 248.

### Active State Power Management

Select Enabled to enable Active-State Power Management for signal transactions between L0 and L1 Links on the PCI Express Bus in order to maximize power-saving and transaction speeds. The options are Enabled and **Disabled**.

### PCIe (PCI Express) Max Read Request Size

Use the arrow key to select the maximum Read Request Size for the onboard PCI-E devices. Select Auto for the system to automatically set the maximum Read Request Size for the PCI-E devices. The options are **Auto**, 128 Bytes, 256 Bytes, 512 Bytes, 1024 Bytes, 2048 Bytes, and 4096 Bytes,

### PCI Slot 1 Option ROM/PCI Slot 2 Option ROM/PCIe Slot 3 Option ROM/ PCIe Slot 4 Option ROM/PCIe Slot 5 Option ROM/PCIe Slot 7 Option ROM

Select Enabled to boot the system from a network device installed in a PCI or a PCI-E slot specified by the user. The options are Disabled and **Enabled**.

---

## Load Onboard LAN1 Option ROM/Load Onboard LAN2 Option ROM

Select Enabled to enable LAN OPROM for PXE. This is to boot computers using a network interface. The options are **Disabled** and Enabled.

## ► Super IO Device Configuration

### Serial Port1/Serial Port2

Select Enabled to enable COM Port1 or COM Port2. The options are **Enabled** and Disabled. If this feature is set to Enabled, the following item will display:

### Serial Port 1 Setting/Serial Port 2 Setting

This feature allows the user to set the address and IRQ setting to optimize IO performance for the device installed in COM Port 1 or COM Port 2. The options for Serial Port 1 are **Auto**, IO=3F8h, IRQ=4; IO=3F8h, IRQ=4, 10, 11; IO=2F8h, IRQ=3, 10, 11; IO=3E8h, IRQ=4, 10, 11; and IO=2E8h, IRQ=3, 10, 11. The options for Serial Port2 are **Auto**, IO=2F8h, IRQ=3; IO=3F8h, IRQ=4, 10, 11; IO=2F8h, IRQ=3, 10, 11; IO=3E8h, IRQ=4, 10, 11; and IO=2E8h, IRQ=3, 10, 11.

## ► Hardware Health Configuration

This feature allows the user to monitor Hardware Health of the system and review the status of each item when displayed.

### Fan Speed Control Mode

This feature allows the user to decide how the system controls the speeds of the onboard fans. The CPU temperature and the fan speed are correlated. When the CPU on-die temperature increases, the fan speed will also increase for proper system cooling. Select "Full Speed" to allow the onboard fans to run at full speed for maximum cooling. The Full Speed setting is recommended for special system configuration or debugging. Select "Optimal" for better system cooling. The Optimal setting is recommended for high-power-consuming and high-density systems. Select "Standard" for the onboard fans to run at a speed that will balance the needs between system cooling and power saving. The Standard setting is recommended for regular systems with normal hardware configuration. The Options are: Full Speed, Optimal and **Standard**.

### CPU Temperature/System Temperature/Peripheral Temperature

This feature displays current temperature readings for the CPU, the system and the peripheral devices.

The following items will be displayed for your reference only:

## CPU Temperature

The CPU thermal technology that reports absolute temperatures (Celsius/Fahrenheit) has been upgraded to a more advanced feature by Intel in its newer processors. The basic concept is each CPU is embedded by unique temperature information that the motherboard can read. This 'Temperature Threshold' or 'Temperature Tolerance' has been assigned at the factory and is the baseline on which the motherboard takes action during different CPU temperature conditions (i.e., by increasing CPU Fan speed, triggering the Overheat Alarm, etc). Since CPUs can have different 'Temperature Tolerances', the installed CPU can now send information to the motherboard what its 'Temperature Tolerance' is, and not the other way around. This results in better CPU thermal management.

Supermicro has leveraged this feature by assigning a temperature status to certain thermal conditions in the processor (Low, Medium and High). This makes it easier for the user to understand the CPU's temperature status, rather than by just simply seeing a temperature reading (i.e., 25°C). The CPU Temperature feature will display the CPU temperature status as detected by the BIOS:

**Low** – This level is considered as the 'normal' operating state. The CPU temperature is well below the CPU 'Temperature Tolerance'. The motherboard fans and CPU will run normally as configured in the BIOS (Fan Speed Control).

User intervention: No action required.

**Medium** – The processor is running warmer. This is a 'precautionary' level and generally means that there may be factors contributing to this condition, but the CPU is still within its normal operating state and below the CPU 'Temperature Tolerance'. The motherboard fans and CPU will run normally as configured in the BIOS. The fans may adjust to a faster speed depending on the Fan Speed Control settings.

User intervention: No action is required. However, consider checking the CPU fans and the chassis ventilation for blockage.

**High** – The processor is running hot. This is a 'caution' level since the CPU's 'Temperature Tolerance' has been reached (or has been exceeded) and may activate an overheat alarm.

User intervention: If the system buzzer and Overheat LED has activated, take action immediately by checking the system fans, chassis ventilation and room temperature to correct any problems.

 **Notes:** 1. The system may shut down if it continues for a long period to prevent damage to the CPU.

2. The information provided above is for your reference only. For more information on thermal management, please refer to Intel's Web site at [www.Intel.com](http://www.Intel.com).

**System Temperature/Peripheral Temperature:** The system temperature and the peripheral temperature will be displayed (in degrees in Celsius and Fahrenheit) as it is detected by the BIOS.

#### **Fan 1 Speed~ Fan 4 Speed, Fan A Speed**

This feature displays the fan speed readings from Fan1~Fan 4 and Fan A.

#### **Voltage Monitoring**

This feature displays the voltage readings for the items below.

Vcore, 12V, V\_DIMM, 5Vcc, VTT\_CPU, AVcc, 3.3Vcc, VSB and VBAT.

### **►ACPI Configuration**

Use this feature to configure Advanced Configuration and Power Interface (ACPI) power management settings for your system.

#### **High Precision Event Timer**

Select Enabled to activate the High Precision Event Timer (HPET) that produces periodic interrupts at a much higher frequency than a Real-time Clock (RTC) does in synchronizing multimedia streams, providing smooth playback and reducing the dependency on other timestamp calculation devices, such as an x86 RDTSC Instruction embedded in the CPU. The High Precision Event Timer is used to replace the 8254 Programmable Interval Timer. The options are **Enabled** and Disabled.

#### **Suspend Mode**

This feature allows the user to select the highest ACPI (Advanced Configuration and Power Interface) sleep state for the system when the user presses the Suspend button. The options are Suspend Disabled, S1 (POS), and **S3 (STR)**.

#### **PS2 KB/MS Wake Up**

This feature allows the user to select PS2 Keyboard/Mouse Wake-Up settings. Select Force Enable to force the keyboard and the mouse to become active whenever a signal is received. Select Force Disable to force the keyboard and the mouse to remain inactive even when a signal is received. Select S1 or S5 to allow the operating system to determine when to wake the onboard keyboard and the mouse. The options are Force Disable, Force Enable, **S1 (OS Control)**, and S5 (OS Control).

## ► Trusted Computing (Available when an Onboard TPM Module is detected)

This feature allows the user to configure Trusting Computing settings.

### TPM Support

Select Enabled to enable TPM (Trusted Platform Module) support for system security and data integrity. The options are **Disabled** and Enabled. If this option is set to Enabled, the following items will display.

### TPM State

Select Enabled to display the status of TPM support for this system. The options are **Disabled** and Enabled. Please note that a system reboot is needed before a change on the TPM state to take effect.

### Pending TPM Operation

This feature is used to schedule a TPM operation that is pending. Select "Enable Take Ownership" to allow the pending TPM operation to take precedence over other operations in the queue and be processed and executed immediately. If the option "Disable Take Ownership" is selected, the pending TPM operation will not take precedence over other operations and will be processed based on the order that are placed in the queue. Select the option "TPM Clear" to delete all pending TPM operations from the queue. If the option "None" is displayed, there is no pending TPM operation in the queue. Please note that a system reboot is needed for any change on the feature to become effective. The options are **None**, Enable Take Ownership, Disable Take Ownership, and TPM Clear.

### Current TPM Status Information

This feature displays the current status of the TPM items listed below.

#### TPM Enabled Status

This item indicates if TPM support is enabled or not in this system.

#### TPM Active Status

This item indicates if TPM support is active or not in this system.

#### TPM Owner State

This feature lists the status of the TPM Owner.



## ► Intel TXT (LT) Configuration (Available when Secure Mode Extension (SMX), Virtual Technology (VT) and VT-d are enabled)

This feature allows the user to configure Intel Trusted Execution Technology Settings. (Please refer to the sections: Processor & Clock and System Agent in the Advanced submenu for VT and VT\_d configuration.)

### Secure Mode Extension (SMX)

This item indicates if SMX is enabled or not.

### Intel TXT (LT) Support

This item indicates if Intel TXT (LT) is enabled or not.

## 4-4 Security

Use this section to configure the privilege level of the user when accessing the system or the Setup Utility.

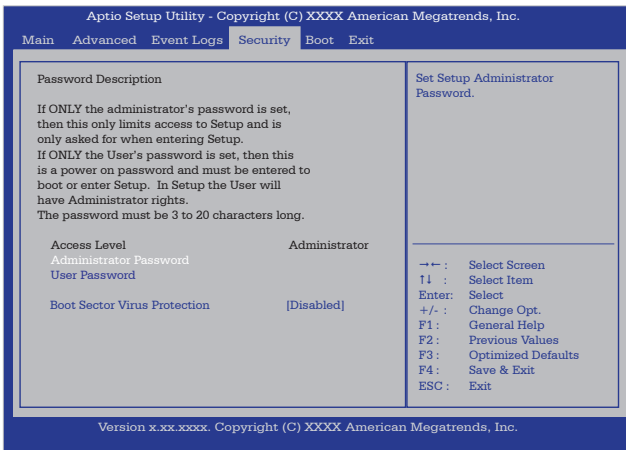

### Access Level

This item displays the access level of the current user.

### Administrator Password

If "Administrator Password" is selected for the system, the user can enter the system and the BIOS Setup utility during system boot. While in the BIOS Setup utility, the user is granted with "Administrator Rights" and is allowed to change configuration settings in the Setup utility. This will allow the user to function as the system administrator and change critical BIOS settings.

## User Password

If User Password is selected for the system, a password is needed for a user to enter the system at bootup or to enter the BIOS Setup utility. While in the BIOS Setup utility, the user is only allowed to view BIOS items without making changes to the BIOS settings.

## Boot Sector Virus Protection

If this feature is enabled, the AMI BIOS displays a warning when any program (or virus) issues a Disk Format command or attempts to write to the boot sector of the hard disk drive. The options are Enabled and **Disabled**.

## 4-5 Boot Configuration

Use this feature to configure Boot Settings:

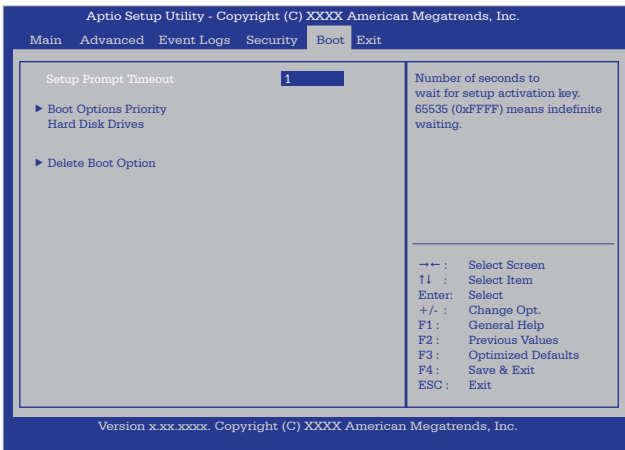

### Setup Prompt Timeout

This feature allows the user to specify how many seconds the system shall wait for the BIOS setup activation key to complete the tasks before the system resumes the normal operation. The default setting is **1 Second**.

### ▶ Boot Options Priority

#### Boot Options Priority

Use this feature to set the system boot sequence. If Built-in EFI (Extensible Firmware Interface) Shell is selected, the Built-in EFI Shell will become the first component to boot. The options are **Disabled** and Built-in EFI Shell. Boot Options Priority

## ► Delete Boot Option

Use this feature to remove an EFI boot option from the boot order.

## 4-6 Exit Options

Select the Exit tab from the AMI BIOS Setup Utility screen to enter the Exit BIOS Setup screen.

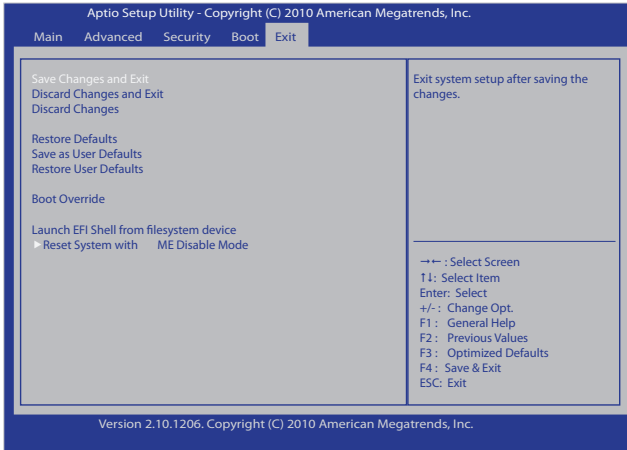

### Save Changes and Exit

After completing the system configuration changes, select this feature and press <Yes> in the dialog box to save the changes you've made and reboot the system. The new system settings will take effect after the system reboot.

### Discard Changes and Exit

Select this feature and press <Yes> in the dialog box to quit the BIOS Setup without making any permanent changes to the system configuration settings.

### Discard Changes

Select Discard Changes and press <Yes> in the dialog box to discard any changes you've made and return to the Setup Utility.

### Restore Defaults

Select this feature and press <Yes> in the dialog box for the AMI BIOS to automatically load Optimal Defaults that are preset by the manufacturer to the BIOS Settings. The Optimal settings are designed for maximum system performance, but they may not work best for some computer applications.

### **Save as User Defaults**

Select this feature and press <Yes> in the dialog box for the AMI BIOS to save the default settings that you've selected as the "User Defaults" for future use.

### **Boot Override**

#### **Launch EFI Shell from Filesystem Device**

Select this feature and press <Yes> in the dialog box for the AMI BIOS to save the changes you've made on the built-in EFI (Extensible Firmware Interface) Shell settings and reboot the system. This system will then attempt to launch the EFI Shell application (Shellx64.efi) from one of the file system devices that is available.

#### **▶ Reset System with ME Disabled Mode**

Select this feature and press <Enter> to reboot the system without enabling the Management Engine mode.

---

---

## Appendix A

### BIOS Error Beep Codes

During the POST (Power-On Self-Test) routines, which are performed each time the system is powered on, errors may occur.

**Non-fatal errors** are those which, in most cases, allow the system to continue with bootup. The error messages normally appear on the screen.

**Fatal errors** will not allow the system to continue to bootup. If a fatal error occurs, you should consult with your system manufacturer for possible repairs.

These fatal errors are usually communicated through a series of audible beeps. The numbers on the fatal error list correspond to the number of beeps for the corresponding error.

#### A-1 BIOS Error Beep Codes

BIOS Error Beep Codes		
Beep Code/LED	Error Message	Description
1 beep	Refresh	Circuits have been reset. (Ready to power up)
5 short beeps + 1 long beep	Memory error	No memory detected in the system
8 beeps	Display memory read/write error	Video adapter missing or with faulty memory
OH LED On	System OH	System Overheat

## Notes

## Appendix B

### Software Installation Instructions

#### B-1 Installing Drivers

After you've installed the Windows Operating System, a screen as shown below will appear. You are ready to install software programs and drivers that have not yet been installed. To install these software programs and drivers, click the icons to the right of these items. (**Note:** To install the Windows Operating System, please refer to the instructions posted on our website at [http://www.supermicro.com/support/manuals/.](http://www.supermicro.com/support/manuals/))



**Driver/Tool Installation Display Screen**



**Note 1.** Click the icons showing a hand writing on the paper to view the readme files for each item. Click on a computer icon to the right of an item to install this item (from top to the bottom), one at a time. After installing each item, you must reboot the system before proceeding with the next item on the list. The bottom icon with a CD on it allows you to view the entire contents of the CD.

**Note 2.** When making a storage driver diskette by booting into a Driver CD, please set the SATA Configuration to "Compatible Mode" and configure SATA as IDE in the BIOS Setup. After making the driver diskette, be sure to change the SATA settings back to your original settings.

## B-2 Configuring Supero Doctor III

The Supero Doctor III program is a Web-based management tool that supports remote management capability. It includes Remote and Local Management tools. The local management is called the SD III Client. The Supero Doctor III program included on the CDROM that came with your baseboard allows you to monitor the environment and operations of your system. Supero Doctor III displays crucial system information such as CPU temperature, system voltages and fan status. See the Figure below for a display of the Supero Doctor III interface.



**Note:** 1 The default user name and password are ADMIN.

**Note 2:** In the Windows OS environment, the Supero Doctor III settings take precedence over the BIOS settings. When first installed, Supero Doctor III adopts the temperature threshold settings previously set in BIOS. Any subsequent changes to these thresholds must be made within Supero Doctor, since the SD III settings override the BIOS settings. For the Windows OS to adopt the BIOS temperature threshold settings, please change the SDIII settings to be the same as those set in BIOS.

### Supero Doctor III Interface Display Screen-I (Health Information)





## Supero Doctor III Interface Display Screen-II (Remote Control)



**Note:** SD III Software Revision 1.0 can be downloaded from our Web-site at: [ftp://ftp.Supermicro.com/utility/Supero\\_Doctor\\_III/](ftp://ftp.Supermicro.com/utility/Supero_Doctor_III/). You can also download SDIII User's Guide at: <http://www.supermicro.com/PRODUCT/Manuals/SDIII/UserGuide.pdf>. For Linux, we will still recommend that you use Supero Doctor II.

## Notes

---

---

## Appendix C

### UEFI BIOS Recovery Instructions



**Warning!** Do not upgrade the BIOS unless your system has a BIOS-related issue. Flashing the wrong BIOS can cause irreparable damage to the system. In no event shall Supermicro be liable for direct, indirect, special, incidental, or consequential damages arising from a BIOS update. If you need to update the BIOS, do not shut down or reset the system while the BIOS is updating to avoid possible boot failure.

#### C-1 An Overview to the UEFI BIOS

The Unified Extensible Firmware Interface (UEFI) specification provides a software-based interface between the operating system and the platform firmware in the pre-boot environment. The UEFI specification supports an architecture-independent mechanism for add-on card initialization to allow the UEFI OS loader, which is stored in the add-on card, to boot up the system. UEFI offers a clean, hand-off control to a computer system at bootup.

#### C-2 How to Recover the UEFI BIOS Image (-the Main BIOS Block)

An AMIBIOS flash chip consists of a boot sector block and a main BIOS code block (a main BIOS image). The boot sector block contains critical BIOS codes, including memory detection and recovery codes for the user to flash a new BIOS image if the original BIOS image is corrupted. When the system power is on, the boot sector codes execute first. Once it is completed, the main BIOS code will continue with system initialization and bootup.



**Note:** Follow the BIOS Recovery instructions below for BIOS recovery when the main BIOS block crashes. However, when the BIOS Boot sector crashes, you will need to send the motherboard back to Supermicro for RMA repair.

#### C-3 To Recover the Boot Sector Using a USB-Attached Device

This feature allows the user to recover a BIOS image using a USB-attached device without additional utilities used. A USB flash device such as a USB Flash Drive, or

a USB CD/DVD ROM/RW device can be used for this purpose. However, a USB Hard Disk drive cannot be used for BIOS recovery at this time.

To perform UEFI BIOS recovery using a USB-attached device, follow the instructions below.

1. Using a different machine, copy the "Super.ROM" binary image file into the disc Root "\\" Directory of a USB device or a writeable CD/DVD.



**Note:** If you cannot locate the "Super.ROM" file in your driver disk, visit our website at [www.supermicro.com](http://www.supermicro.com) to download the BIOS image into a USB flash device and rename it to "Super ROM" for BIOS recovery use.

2. Insert the USB device that contains the new BIOS image ("Super.ROM") into your USB drive and power on the system
3. While powering on the system, keep pressing <Ctrl> and <Home> simultaneously on your PS2 keyboard until your hear two short beeps. This may take from a few seconds to one minute.
4. After locating the new BIOS binary image, the system will enter the BIOS Recovery menu as shown below.

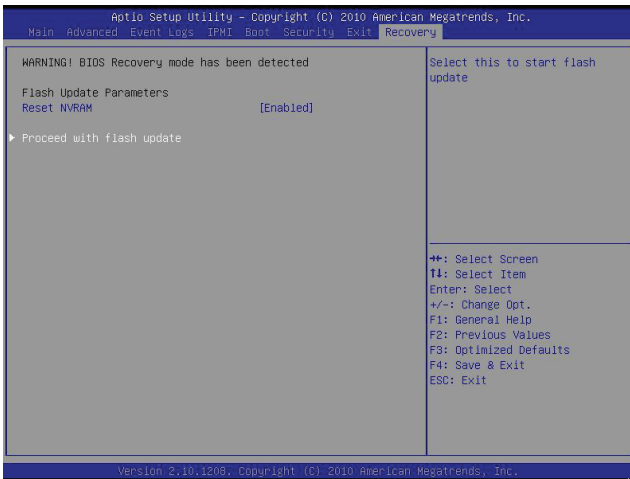

**Note:** At this point, you may decide if you want to start with BIOS Recovery. If you decide to proceed with BIOS Recovery, follow the procedures below.

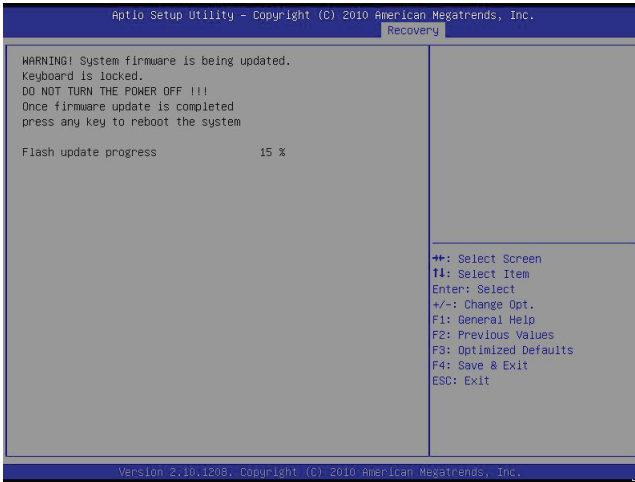

- When the screen as shown above displays, using the arrow key, select the item- "Proceed with flash update" and press the <Enter> key. You will see the progress of BIOS Recovery as shown in the screen below.



 **Note:** Do not interrupt the process of BIOS flashing until it is completed.

- After the process of BIOS Recovery is complete, press any key to reboot the system.
- Using a different system, extract the BIOS package into a bootable USB flash drive.

8. When a DOS prompt appears, enter AMI.BAT BIOSname.### at the prompt.



**Note:** *Do not interrupt this process* until BIOS flashing is completed.

9. After seeing the message that BIOS update is completed, unplug the AC power cable from the power supply to clear CMOS, and then plug the AC power cable in the power supply again to power on the system.
10. Press <Del> continuously to enter the BIOS Setup utility.
11. Press <F3> to load default settings.
12. After loading default settings, press <F4> to save the settings and exit the BIOS Setup utility.

(Disclaimer Continued)

The products sold by Supermicro are not intended for and will not be used in life support systems, medical equipment, nuclear facilities or systems, aircraft, aircraft devices, aircraft/emergency communication devices or other critical systems whose failure to perform be reasonably expected to result in significant injury or loss of life or catastrophic property damage. Accordingly, Supermicro disclaims any and all liability, and should buyer use or sell such products for use in such ultra-hazardous applications, it does so entirely at its own risk. Furthermore, buyer agrees to fully indemnify, defend and hold Supermicro harmless for and against any and all claims, demands, actions, litigation, and proceedings of any kind arising out of or related to such ultra-hazardous use or sale.